

C3

Profundización



Nivel: IX - X

BOOK DE PLANOS

Versión: 4.0

CURSO: ENFASIS DE GRADO

APELLIDOS: HOLGUIN SEPULVEDA – RODRIGUEZ GONZALEZ

NOMBRES: JENIFER KATHERIN – SERGIO ESTEBAN

CODIGOS: 1001328705 - 1001089572

PERIODO ACADEMICO: 2024-II

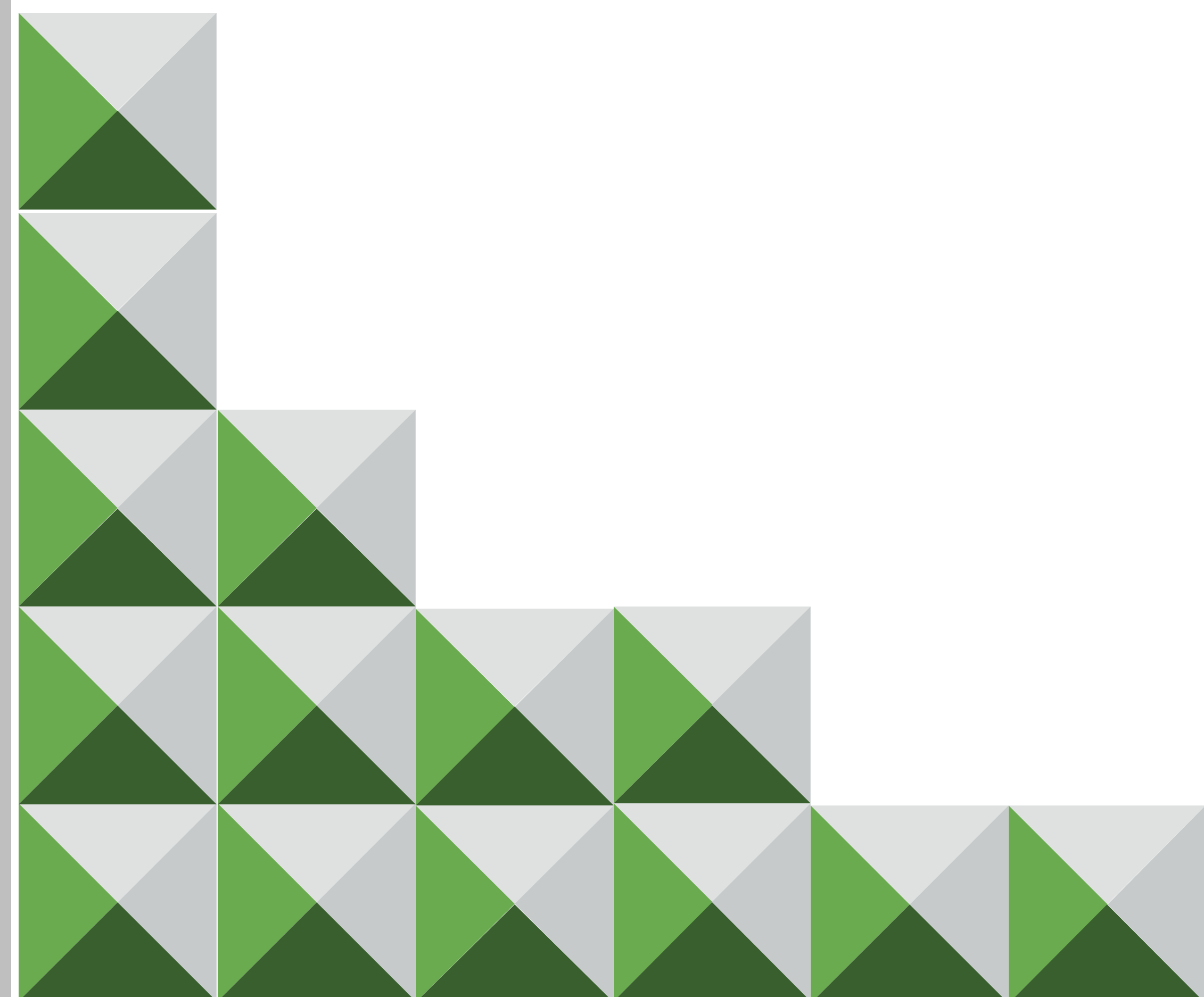

FACULTAD DE
ARQUITECTURA



LOCALIZACIÓN



LOCALIDAD - ENGATIVA



UPZ - GARCES NAVAS

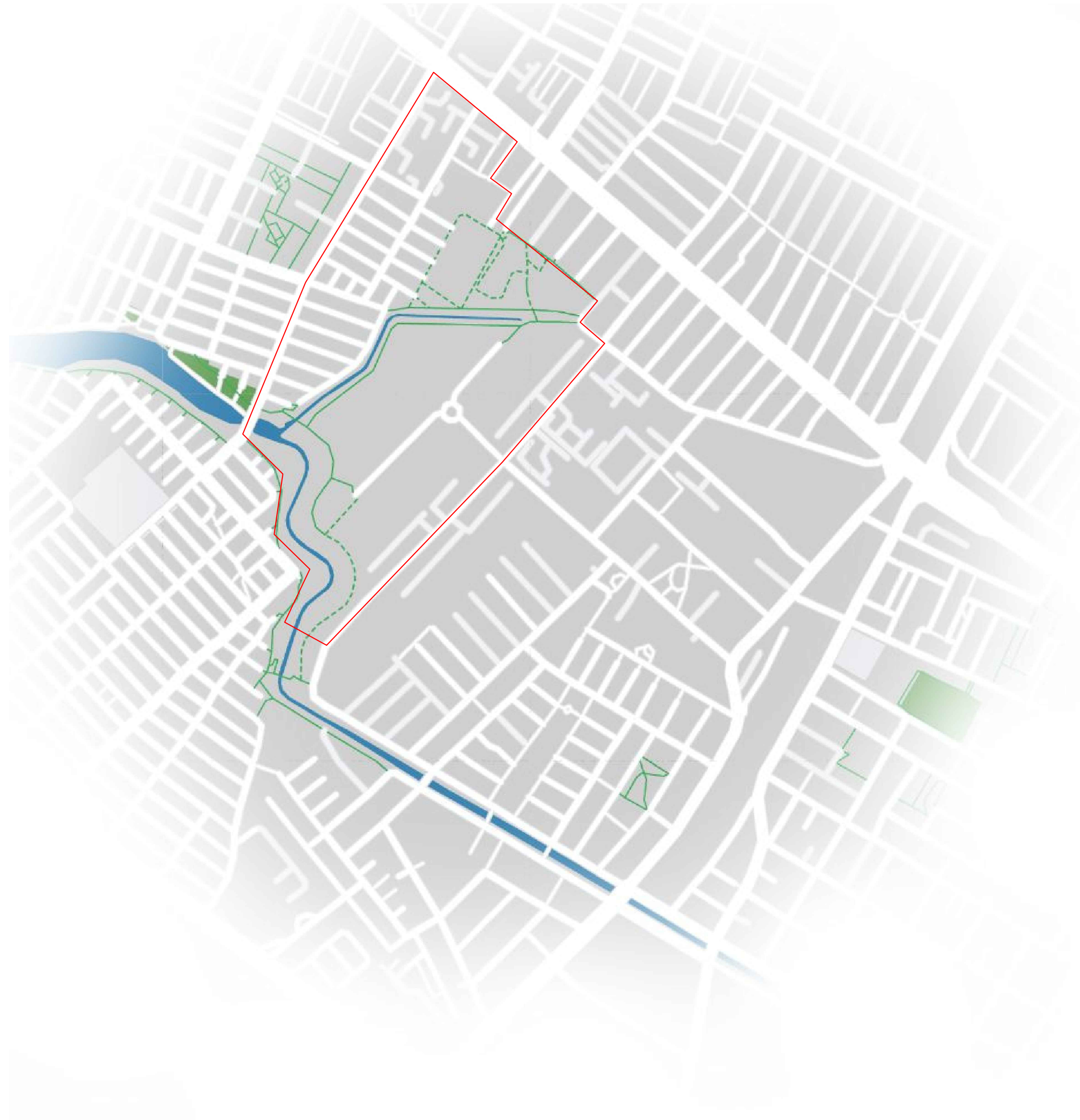

POLÍGONO DE INTERVENCIÓN



TÍTULO DEL PROYECTO:

HUMEDAL
JABOQUE

BOGOTÁ 2024

CONVENCIONES:

CURSO:

ÉNFASIS DE GRADO

CONTIENE:

PLANTA GENERAL -
PROPUESTA URBANA

OBSERVACIONES:

1.

ESCALA:

1/1500

FECHA:

25 DE NOV
DE
2024

NOMBRE DEL ARCHIVO:

PLANIMETRIA-ARBORETUM DEL
JABOQUE.dwg

REVISION:

1

PLANO No.

A-001

PLANCHETA No.

1

DE

1

P1 PLANO URBANO GENERAL
ESCALA 1:1500

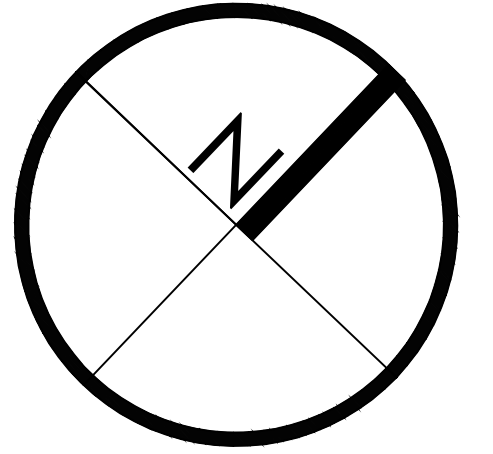



1. ZONAS RECREATIVAS ACTIVAS
2. ZONAS RECREATIVAS PASIVAS
3. ZONA DE PROTECCION

P1

PLANO DE ZONIFICACIÓN GENERAL

ESCALA 1:1500

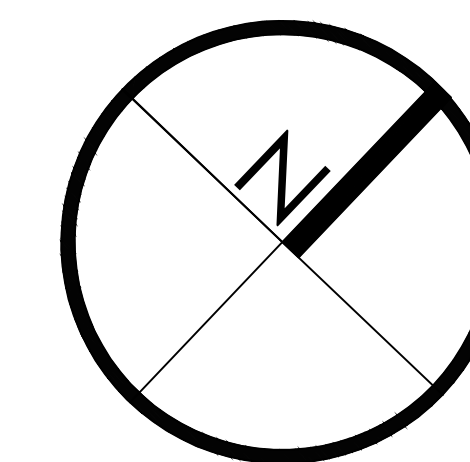



TÍTULO DEL PROYECTO:

HUMEDAL
JABOQUE

BOGOTÁ 2024

CONVENCIONES:

CURSO:

ÉNFASIS DE GRADO

CONTIENE:

PLANTA - PROPUESTA
URBANA

OBSERVACIONES:

1.

ESCALA:

1/1500

FECHA:

25 DE NOV
DE
2024

NOMBRE DEL ARCHIVO:

PLANIMETRIA-ARBORETUM DEL
JABOQUE.dwg

REVISIÓN

1

PLANO No.

A-001

PLANCHA No.

1
DE
1



CHICALA - NOGAL - CEDRO SAUCE - 7 CUEROS - PENICETO - CORTADERA PAPIROS



PAPIROS SAUCE - 7 CUEROS - PENICETO - CORTADERA CHICALA - NOGAL - CEDRO

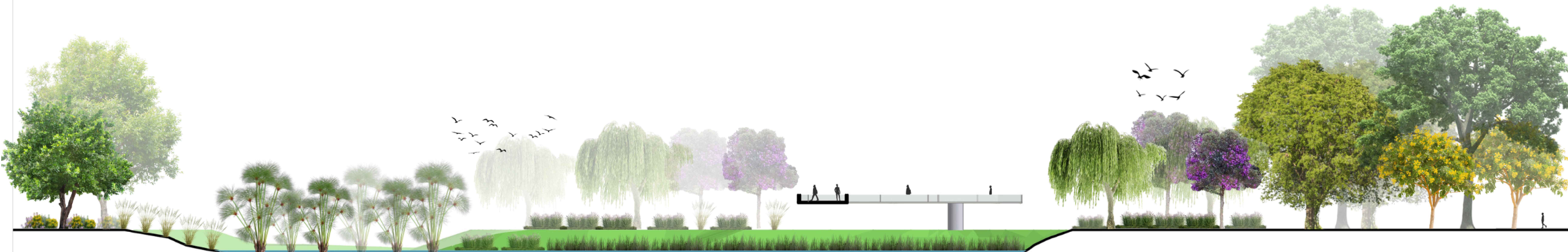

PAPIROS SAUCE - 7 CUEROS - PENICETO - CORTADERA CHICALA - NOGAL - CEDRO

TITULO DEL PROYECTO:

HUMEDAL
JABOQUE

BOGOTÁ 2024

CONVENCIONES:

CURSO:

ENFASIS DE GRADO

CONTIENE:

CORTES - PROPUESTA
URBANA

OBSERVACIONES:

1.

ESCALA:

1/600

FECHA:

25 DE NOV
DE
2024

NOMBRE DEL ARCHIVO:

PLANIMETRIA-ARBORETUM DEL
JABOQUE.dwg

REVISION

1

PLANO No.

A-001

PLANCHA No.

1

DE

1

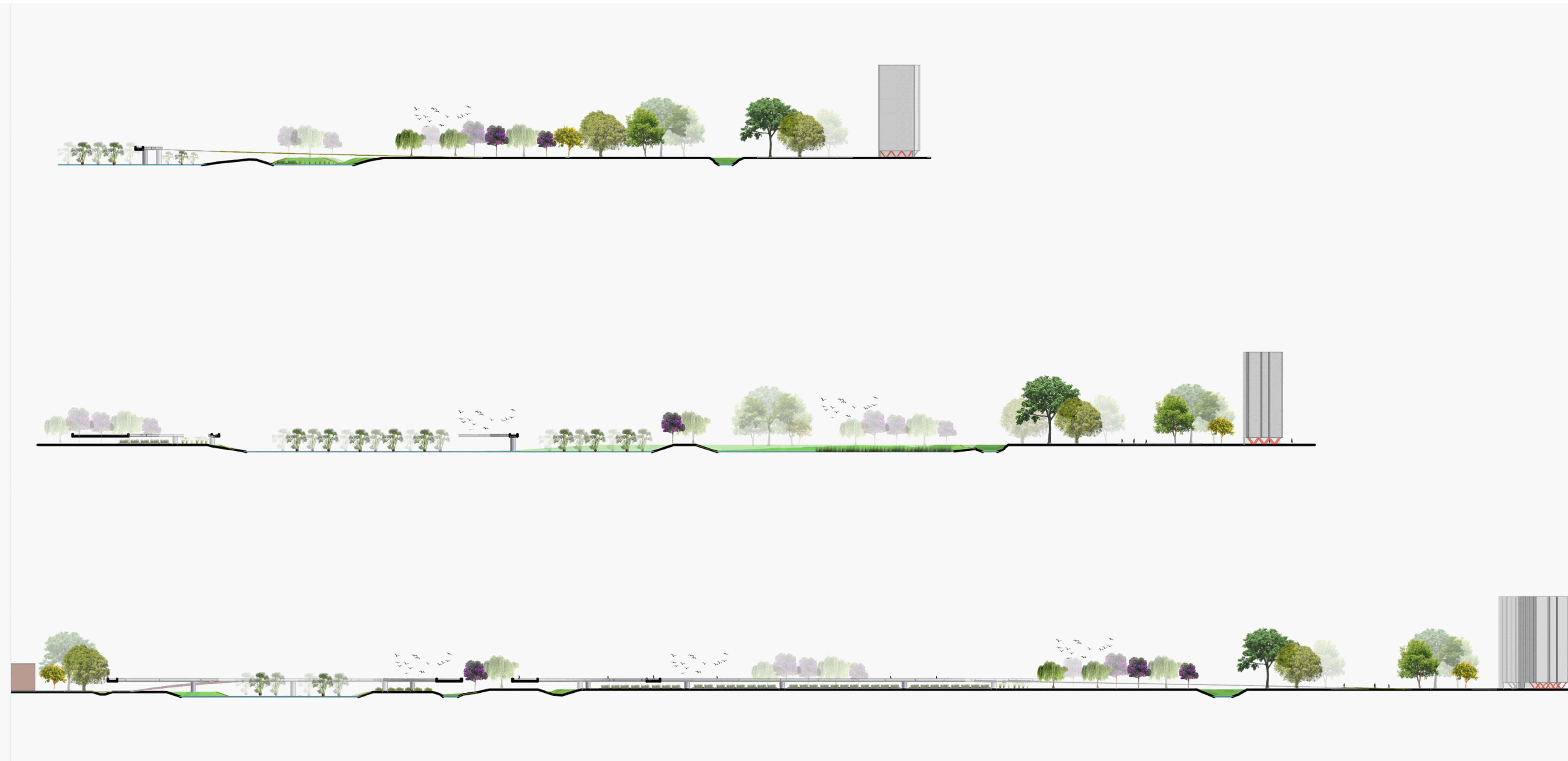

C1

CORTES URBANOS

ESCALA 1:300

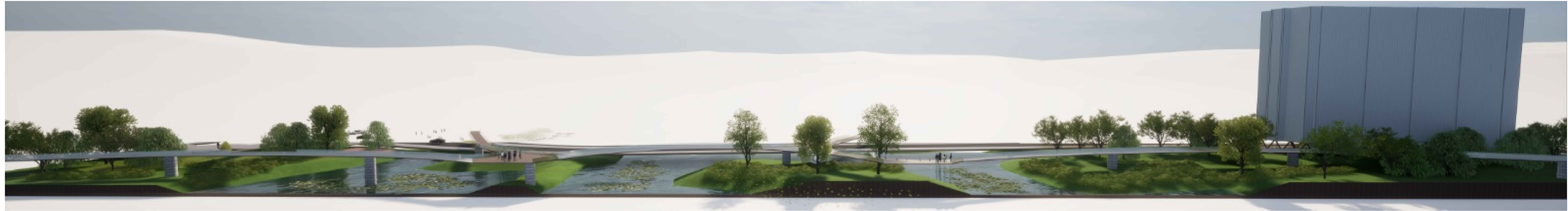

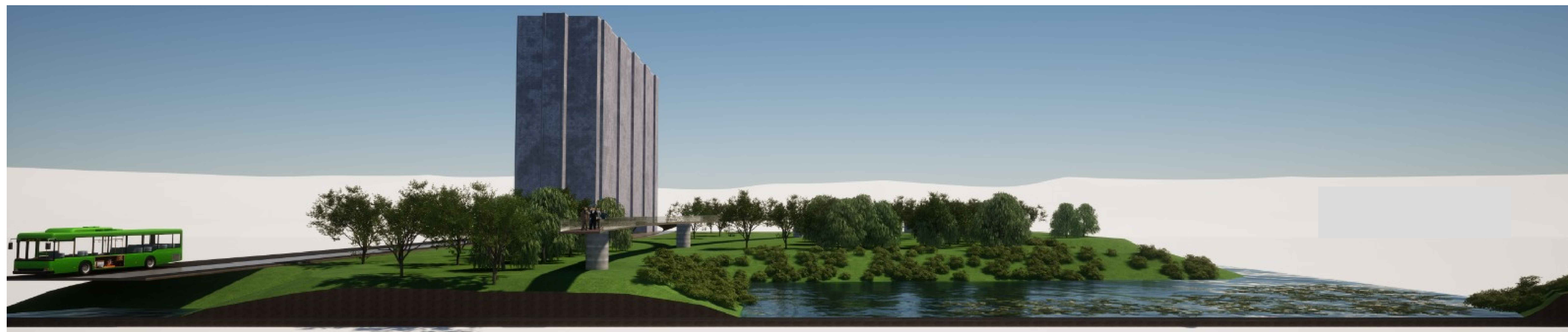

C1 CORTES URBANOS
ESCALA 1:100

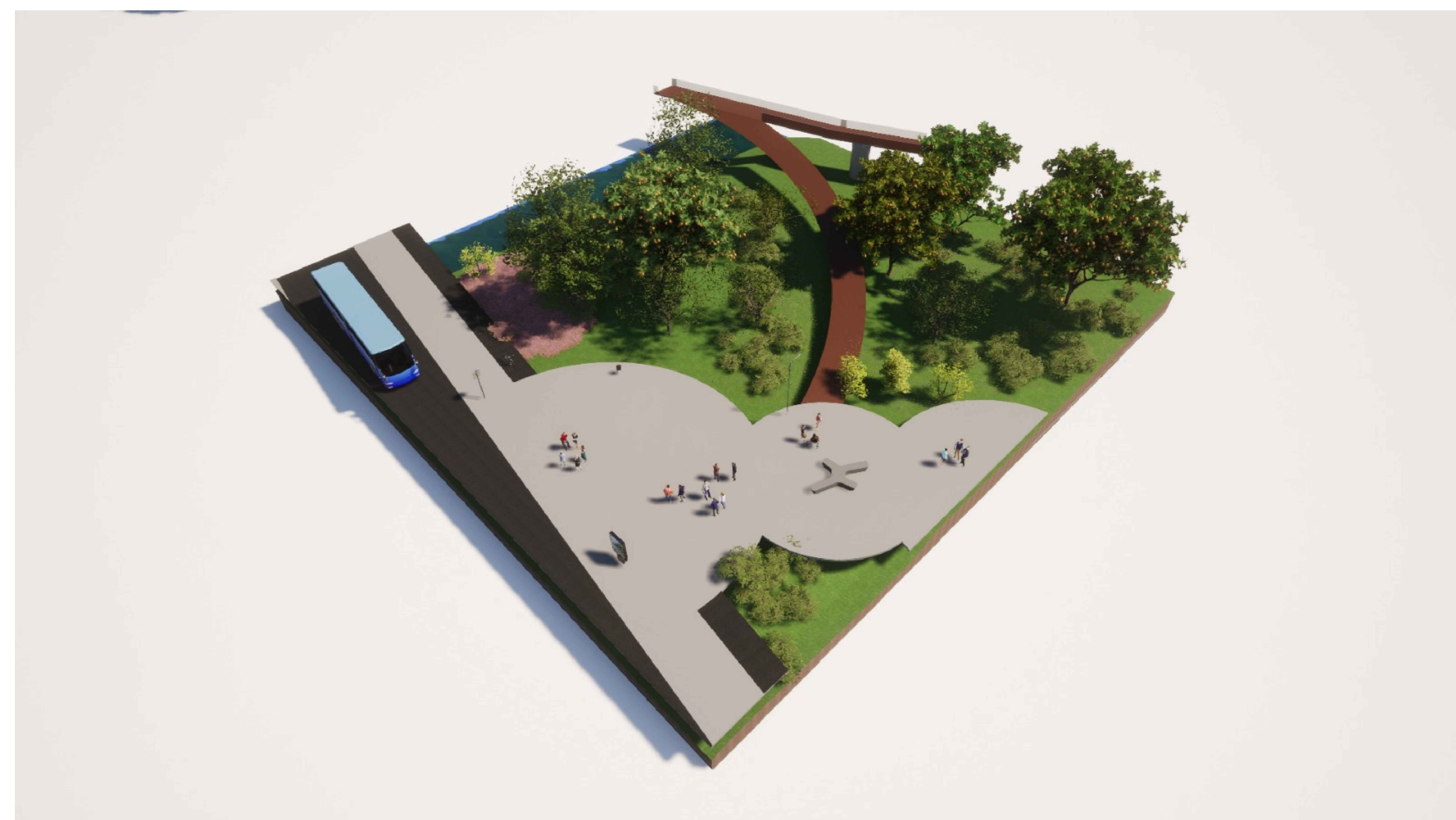

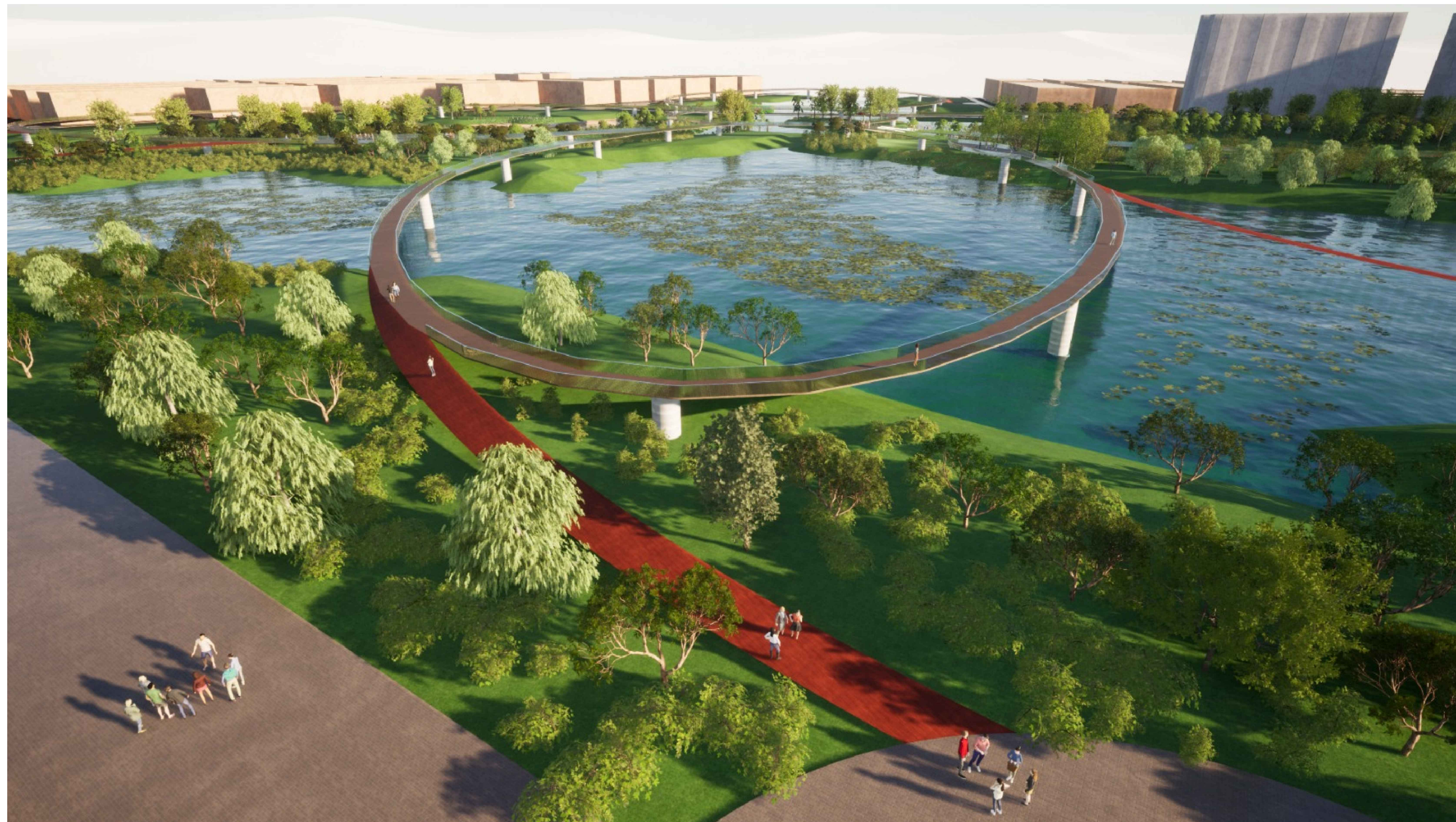

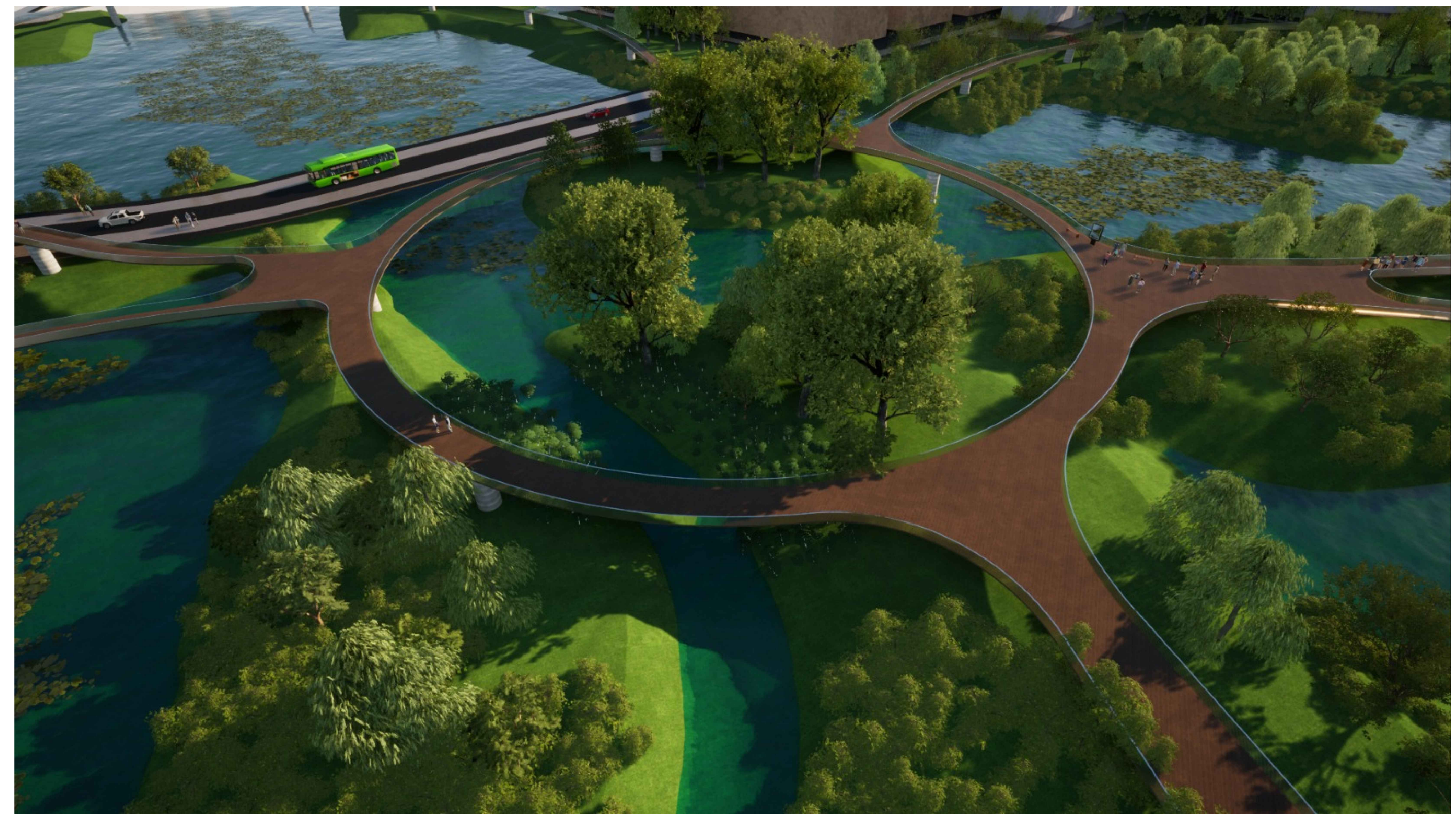
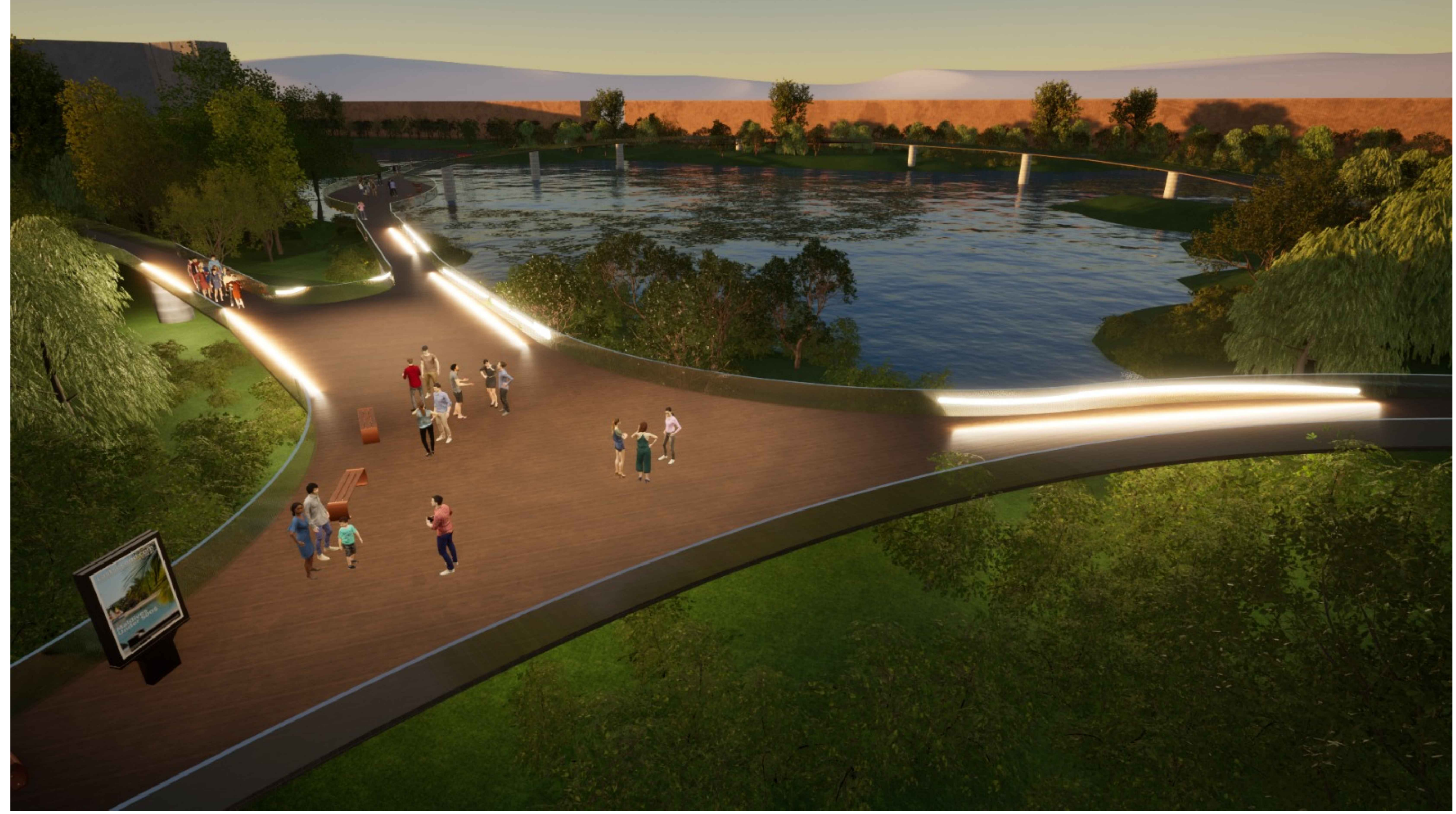
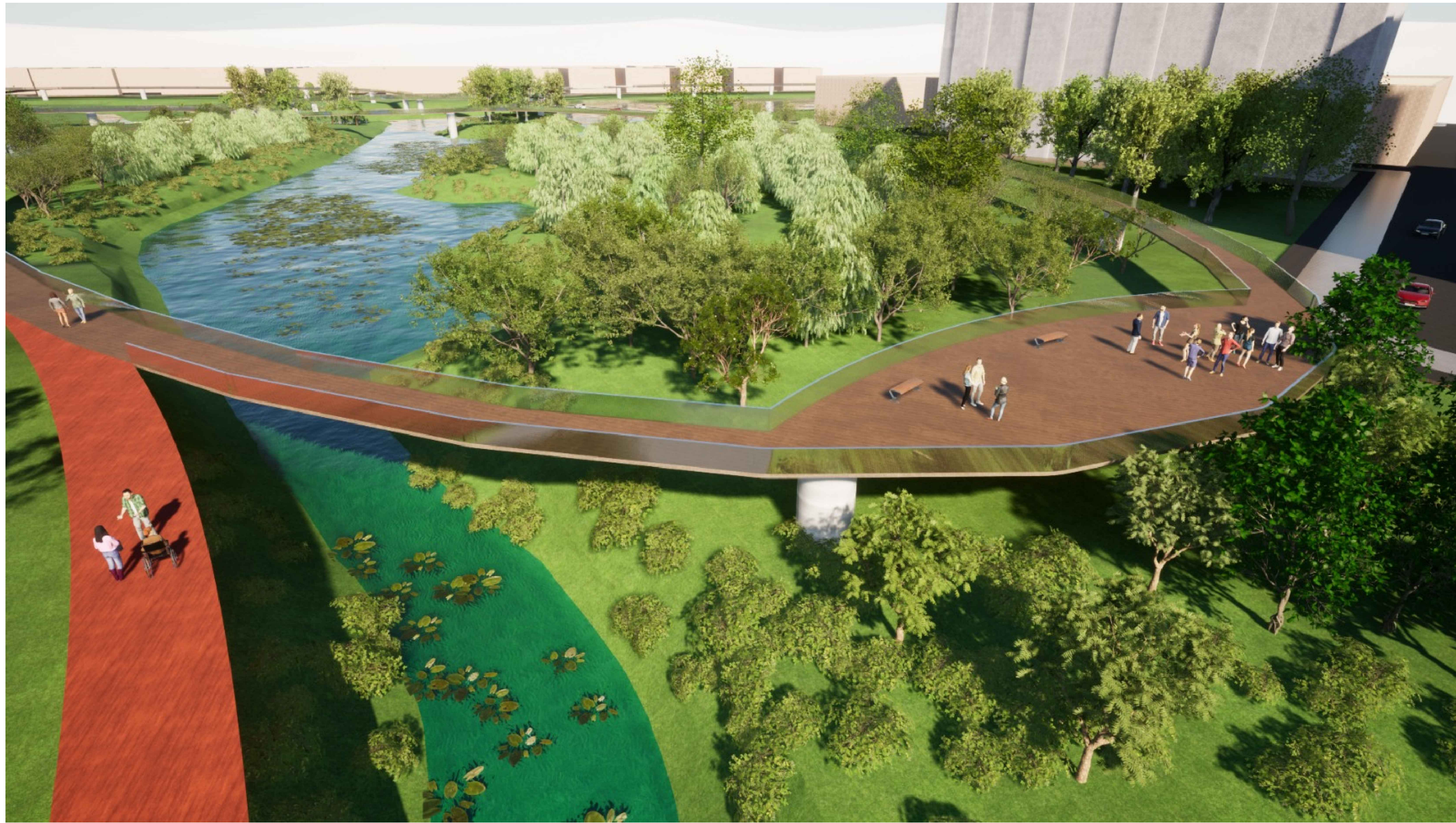

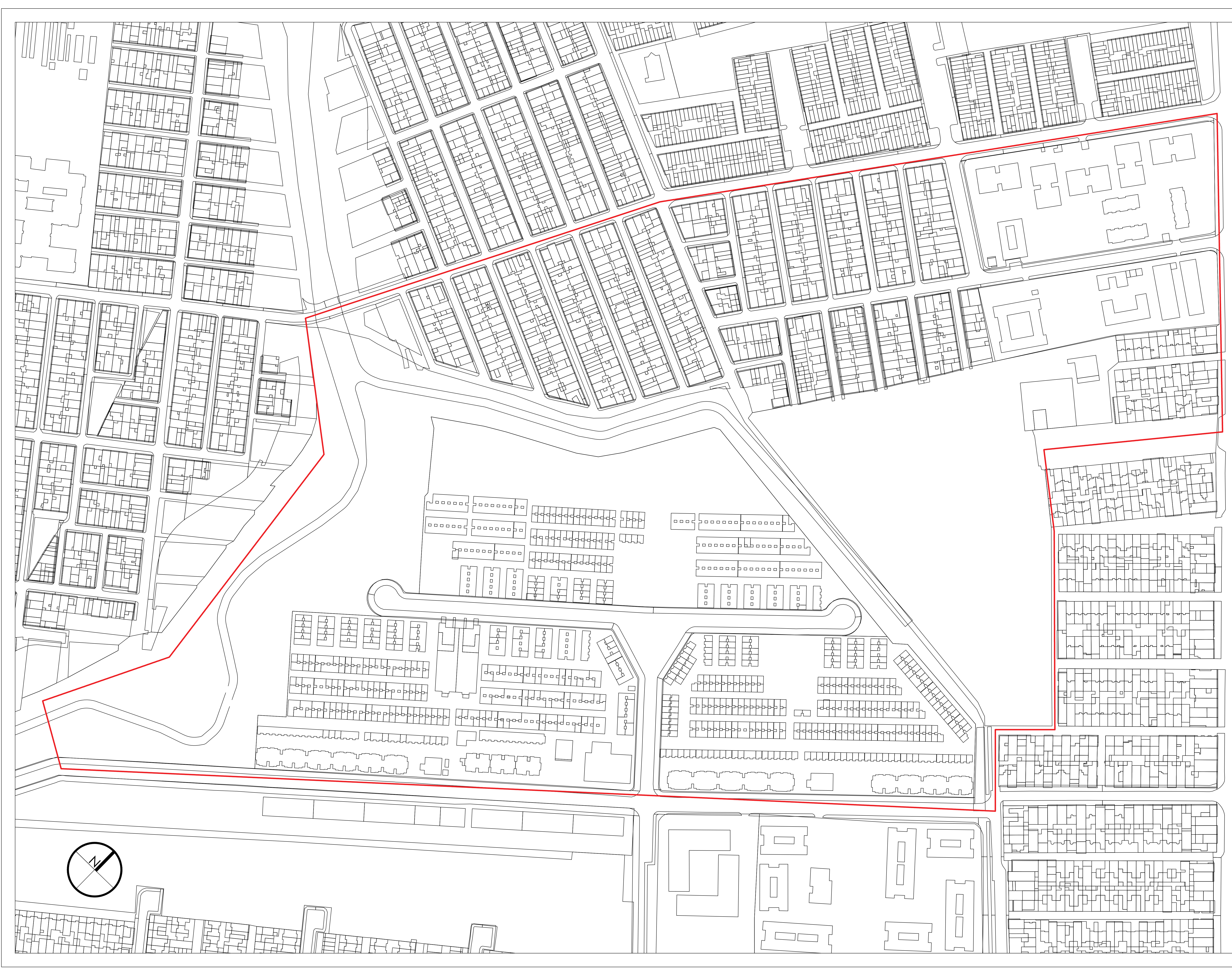
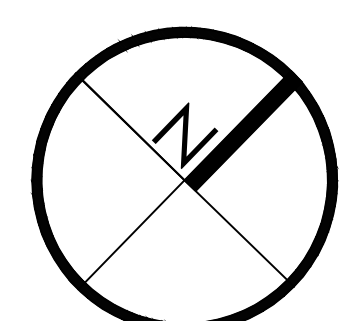

1. ZONAS RECREATIVAS ACTIVAS
2. ZONAS RECREATIVAS PASIVAS
3. ZONA DE PROTECCION

1.

1/1000

29 DE MAYO
DE
2024

Engativa_Propuesta 20-04
(PTG).dwg

1

A-001

1

1

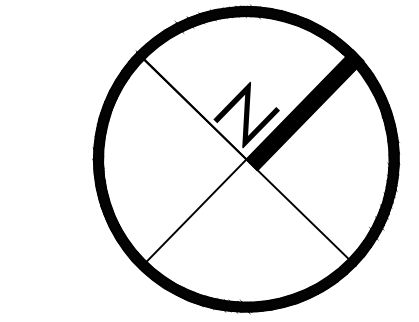
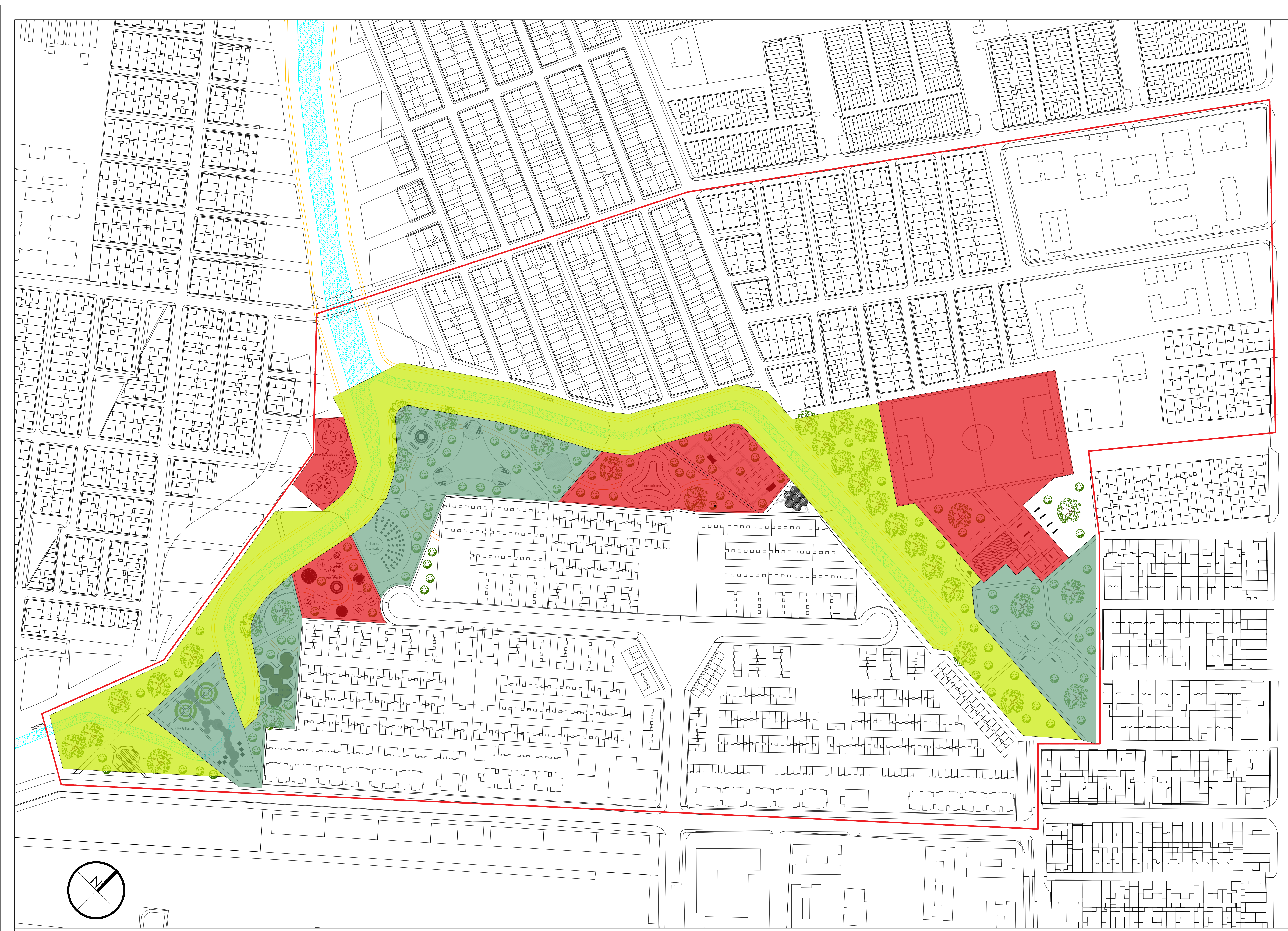

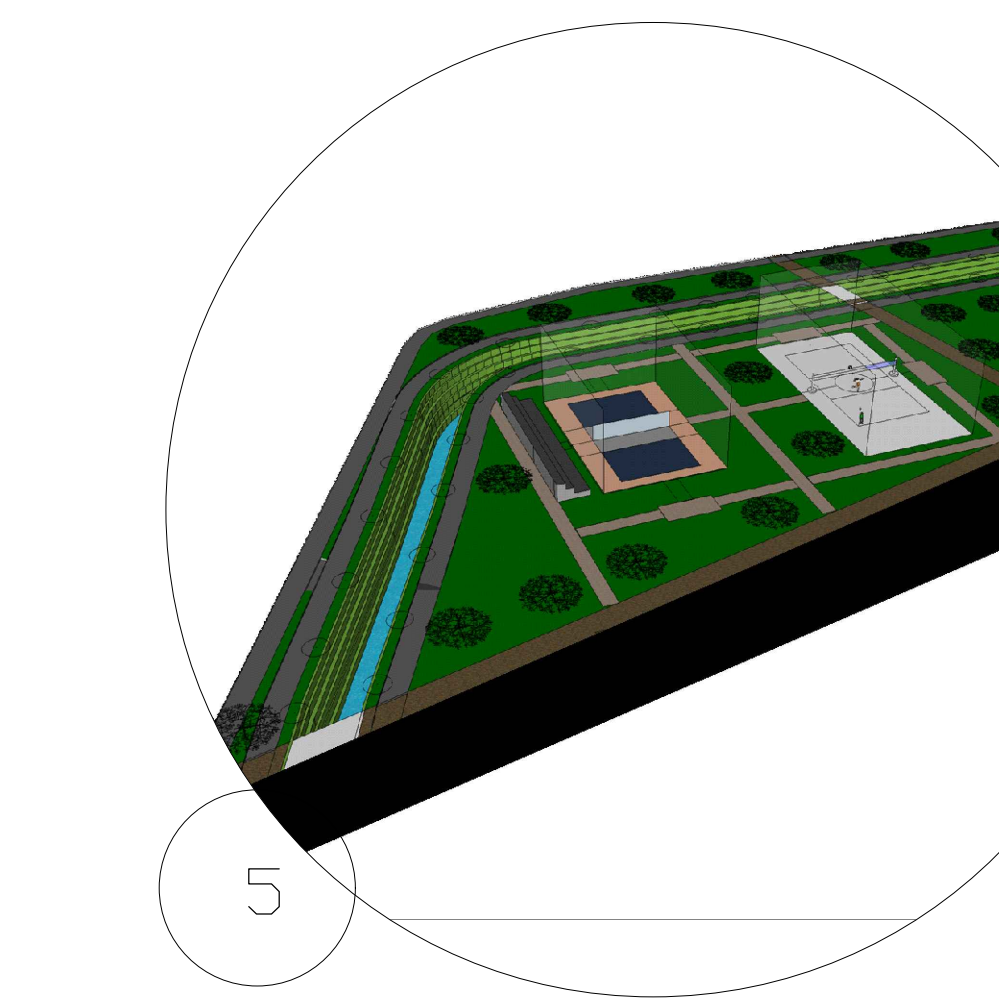
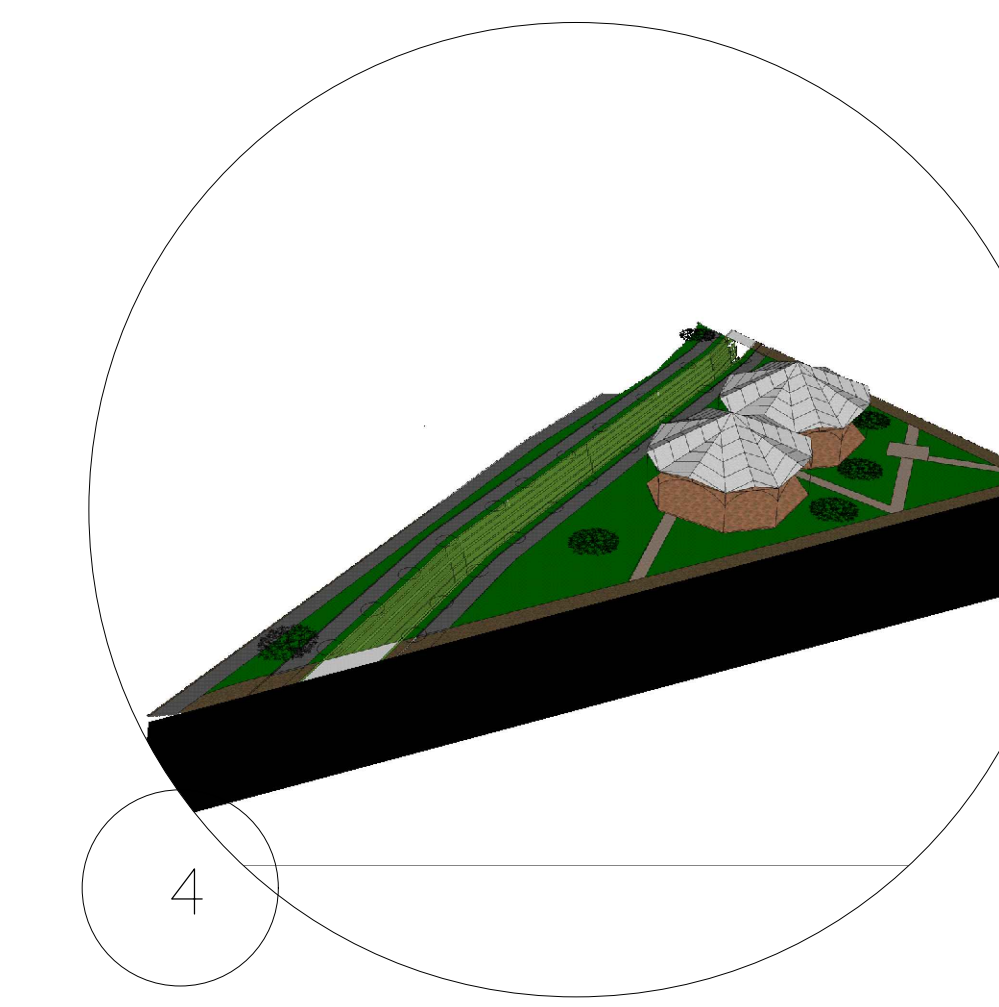
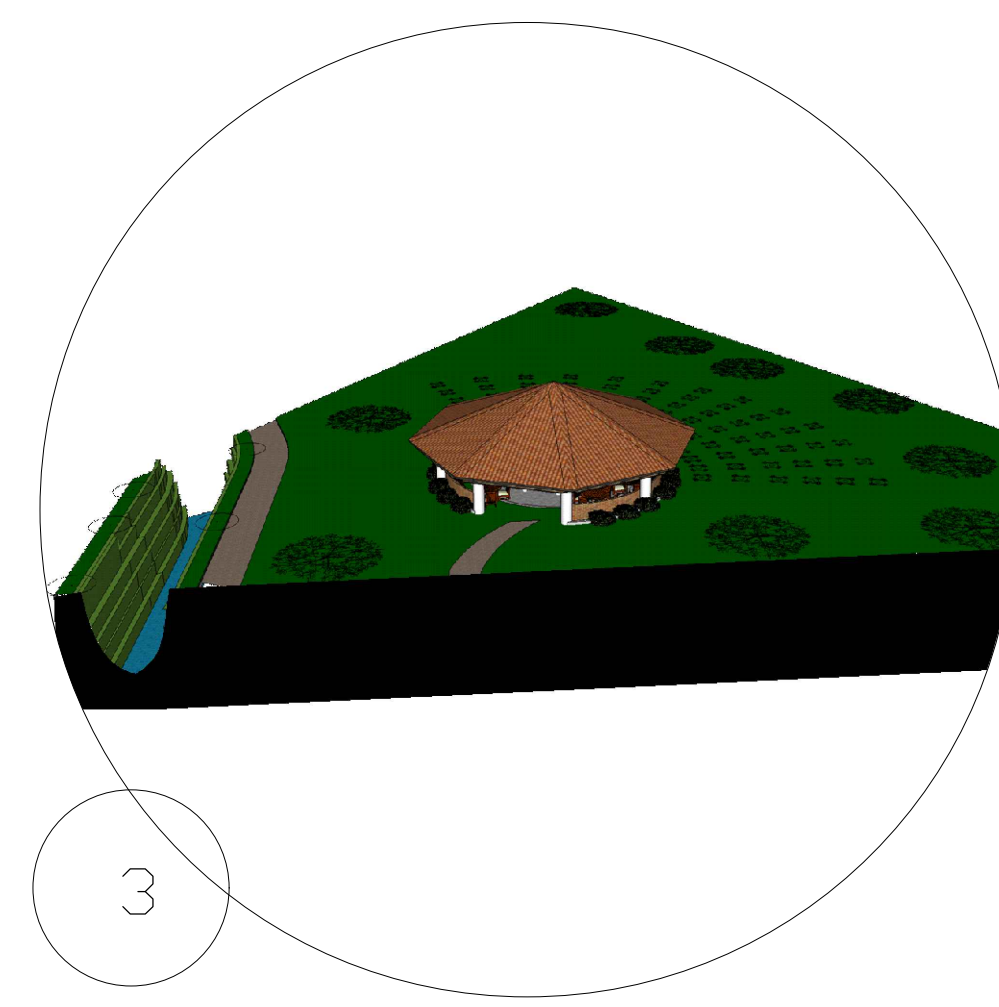
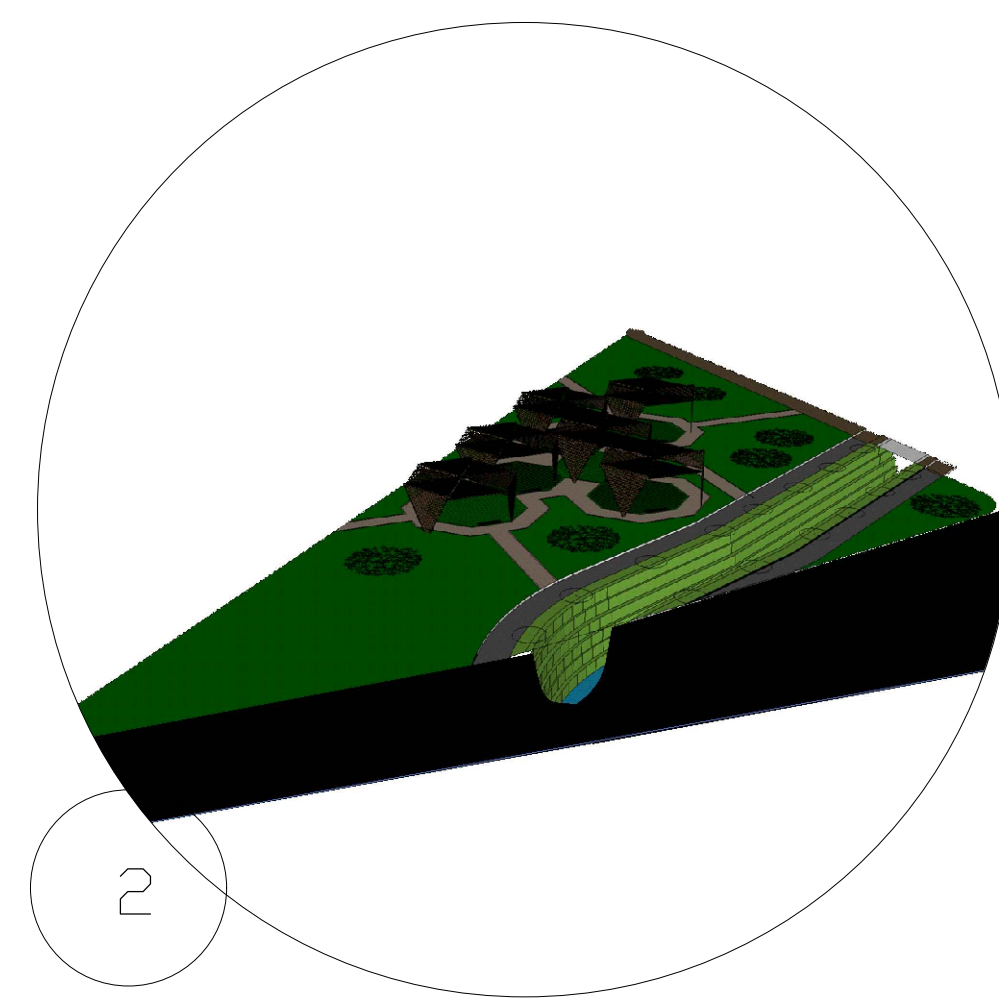
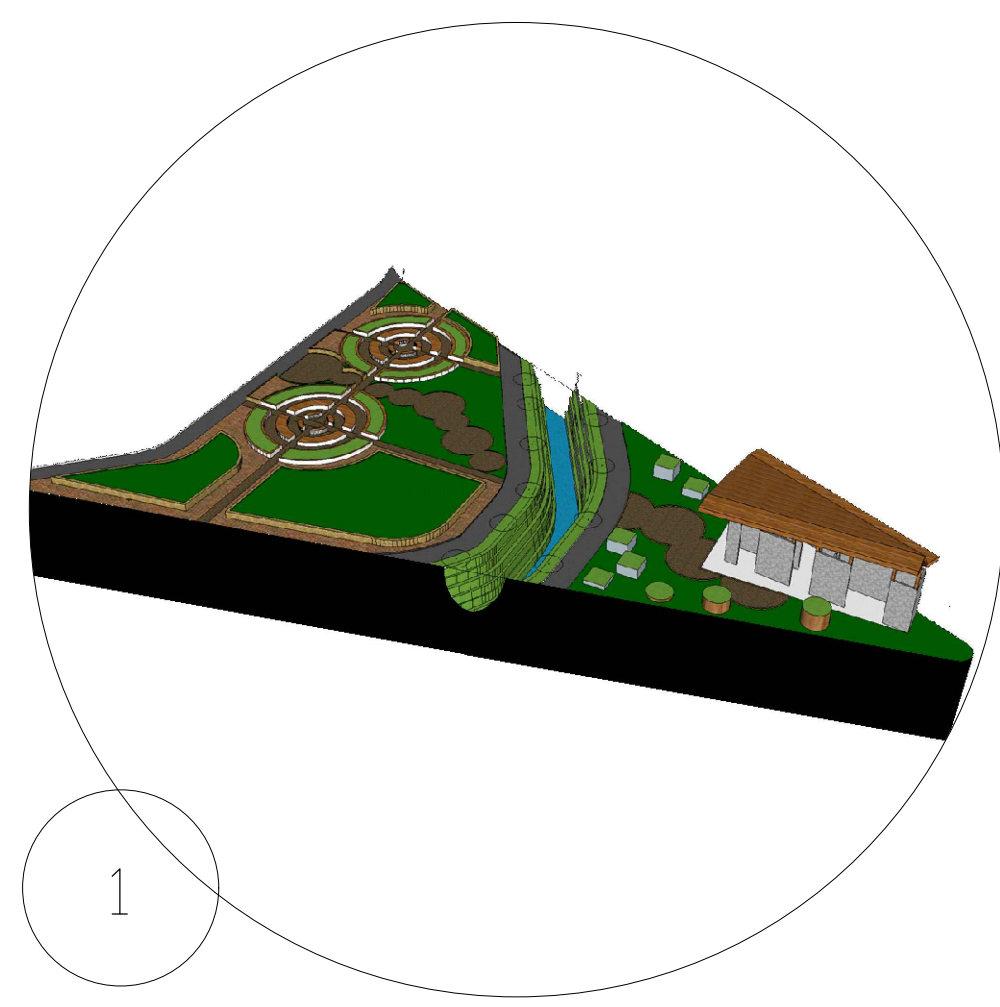

P1 **PLANTA URBANA**
 ESCALA 1:1000

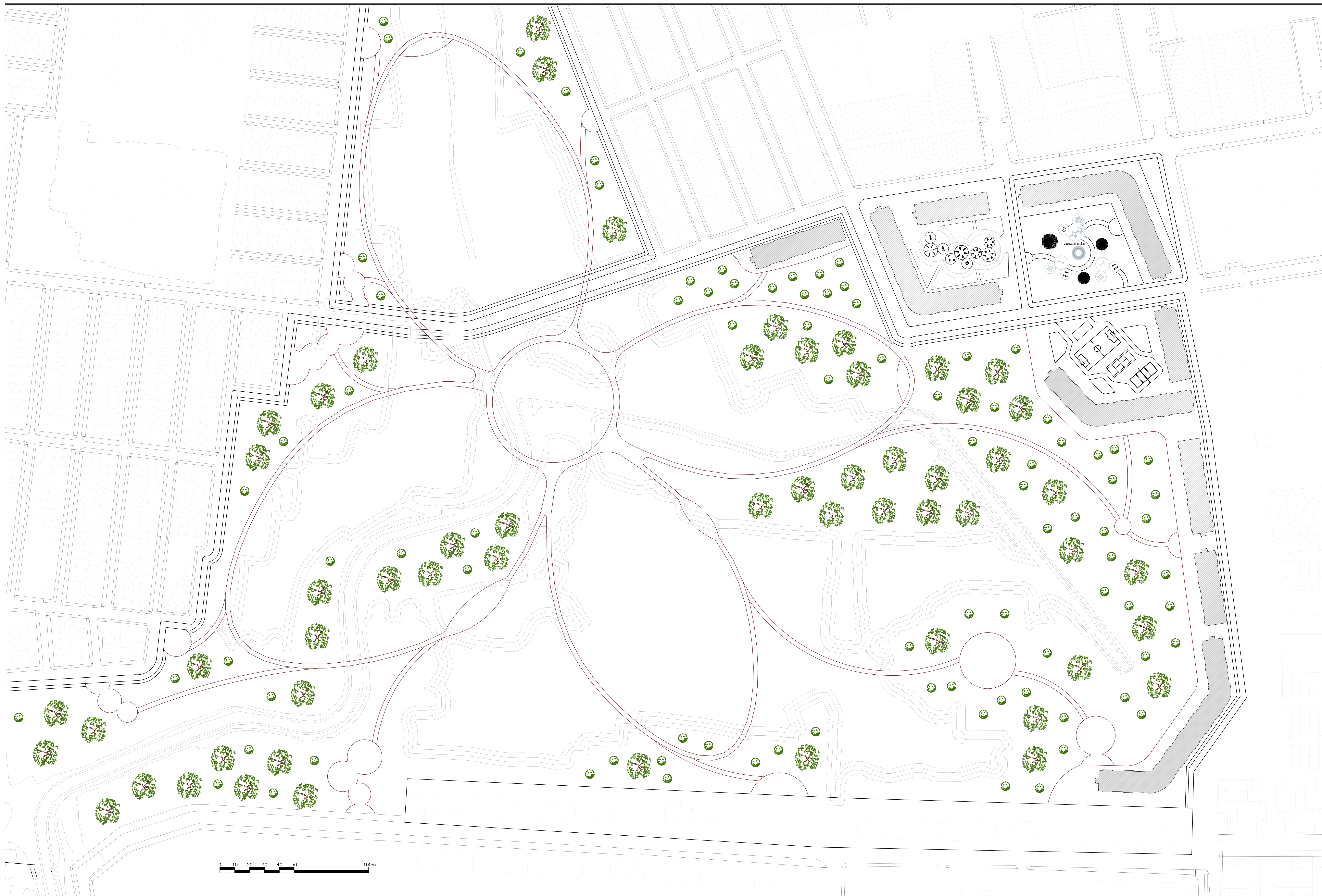

P1 PLANO URBANO GENERAL
ESCALA 1:1000

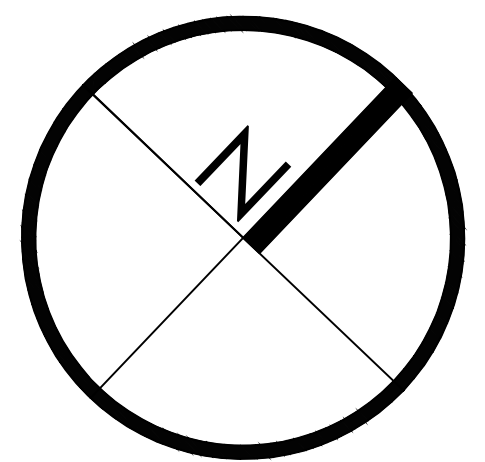



1. ZONAS RECREATIVAS ACTIVAS
2. ZONAS RECREATIVAS PASIVAS
3. ZONA DE PROTECCION

- 1.

P1

PLANO DE ZONIFICACIÓN GENERAL

ESCALA 1:1000

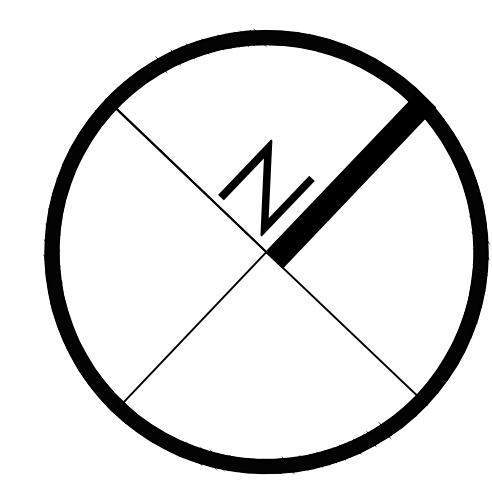

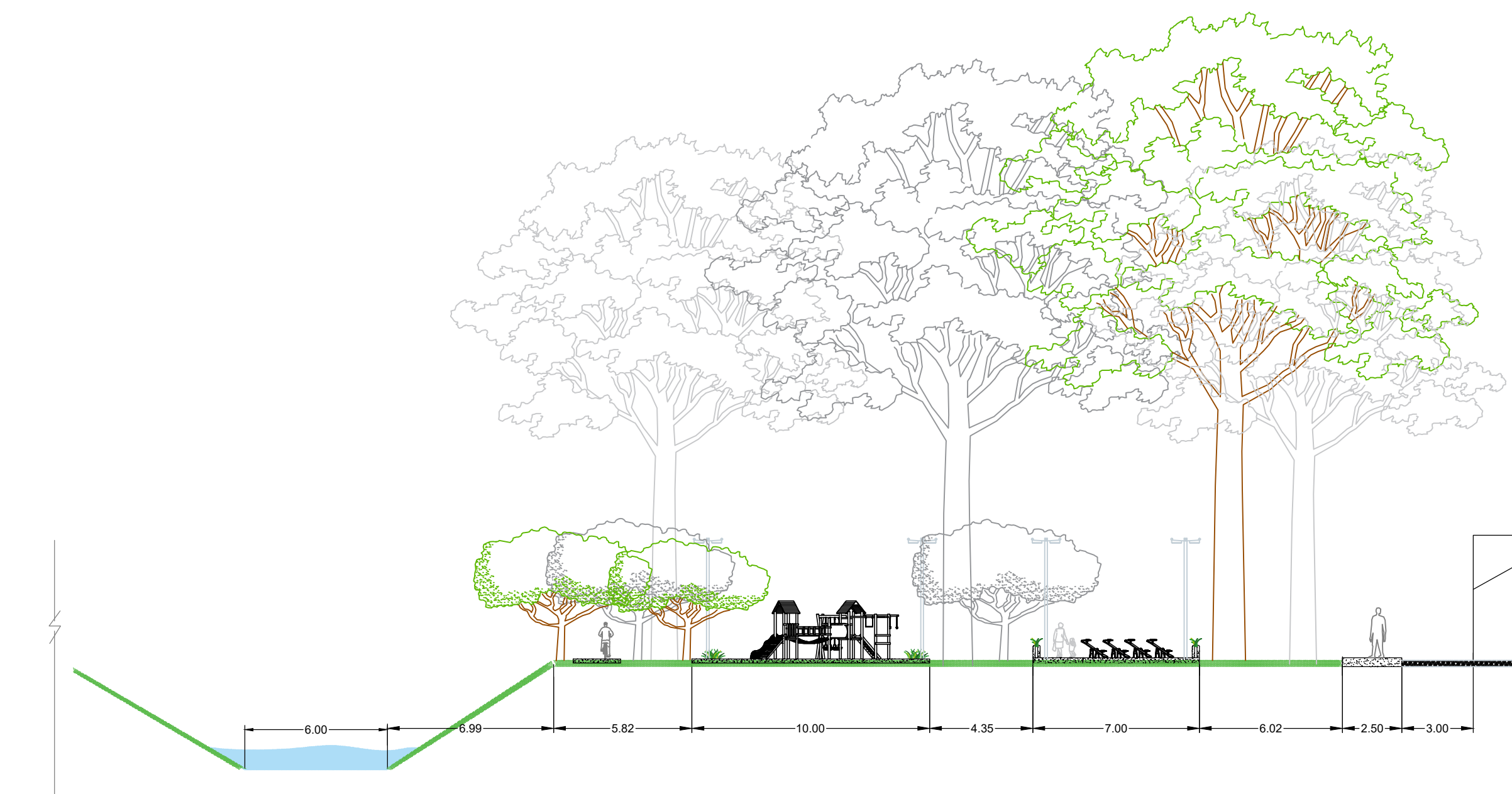

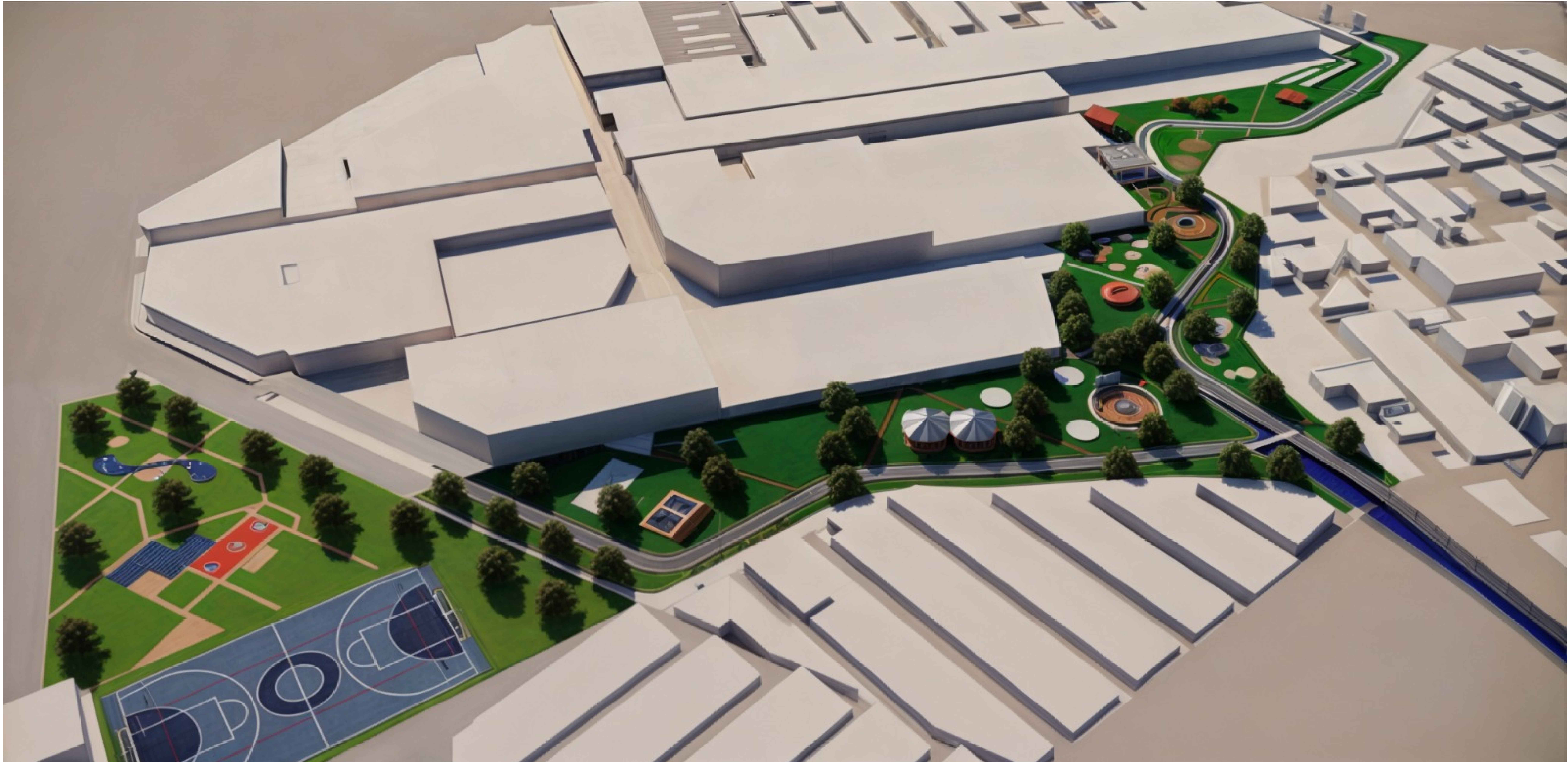



DIAGNÓSTICO ECOLÓGICO



Legend

- zonas_verdes_Cli
- CONS_Clip
- agua_corte
- Localidad



DIAGNÓSTICO FUNCIONAL

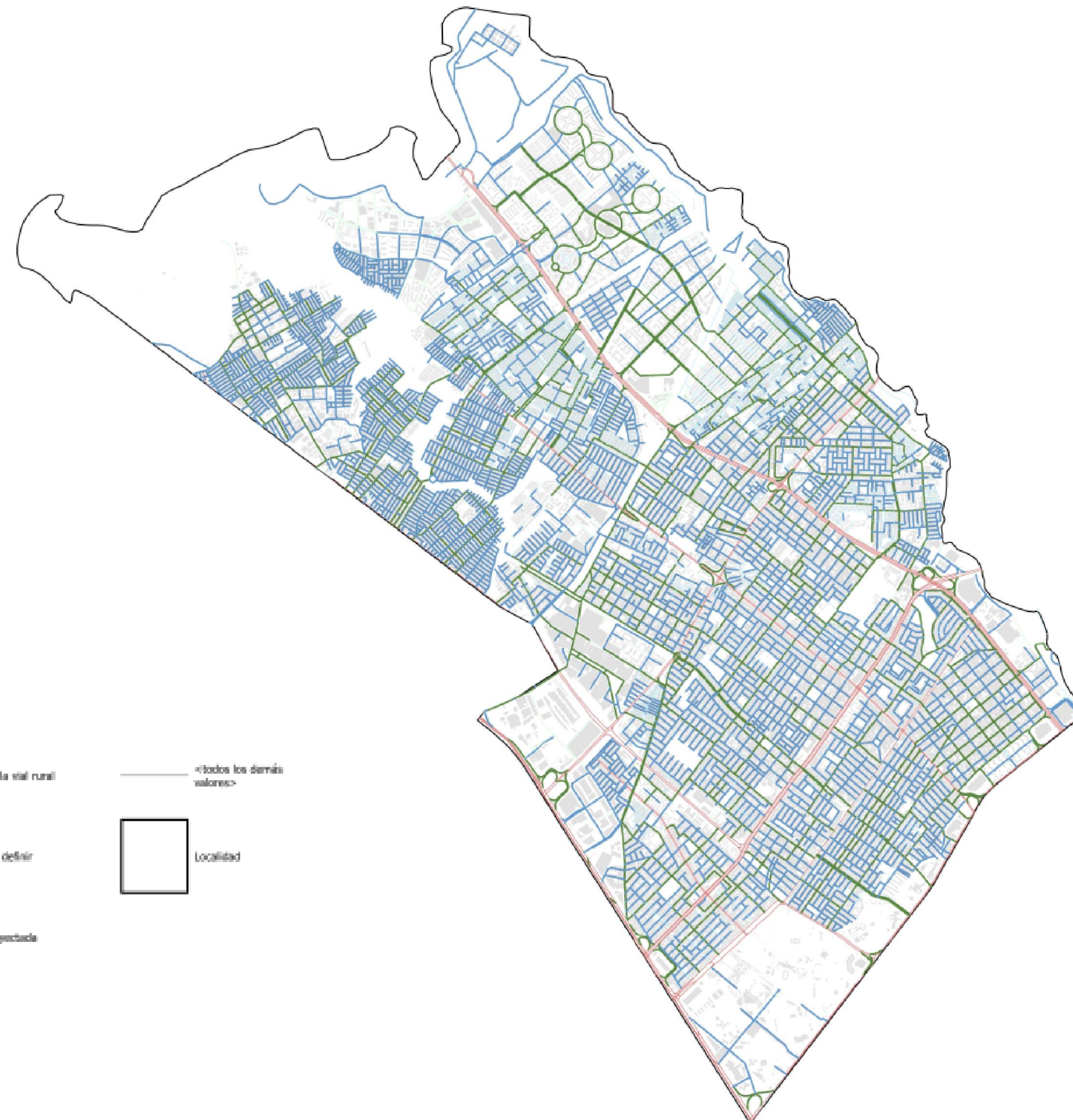

Legend



DIAGNÓSTICO DE LLENOS Y VACIOS



Legend



DIAGNÓSTICO DE USOS



Usos_suelo
Equipamien
sin información
Agrícola
Bodegas y depósitos
Comercial
Cultural

Legend

Educación
Hoteles
Iglesias o cementerios
Industrial
Instalaciones militares
Institucional
Oficinas
Oficinas y depósitos
Plazas de mercado
Predios sin construir
Salud
Vivienda
Localidad

DIAGNÓSTICO DE ESTRATIFICACIÓN

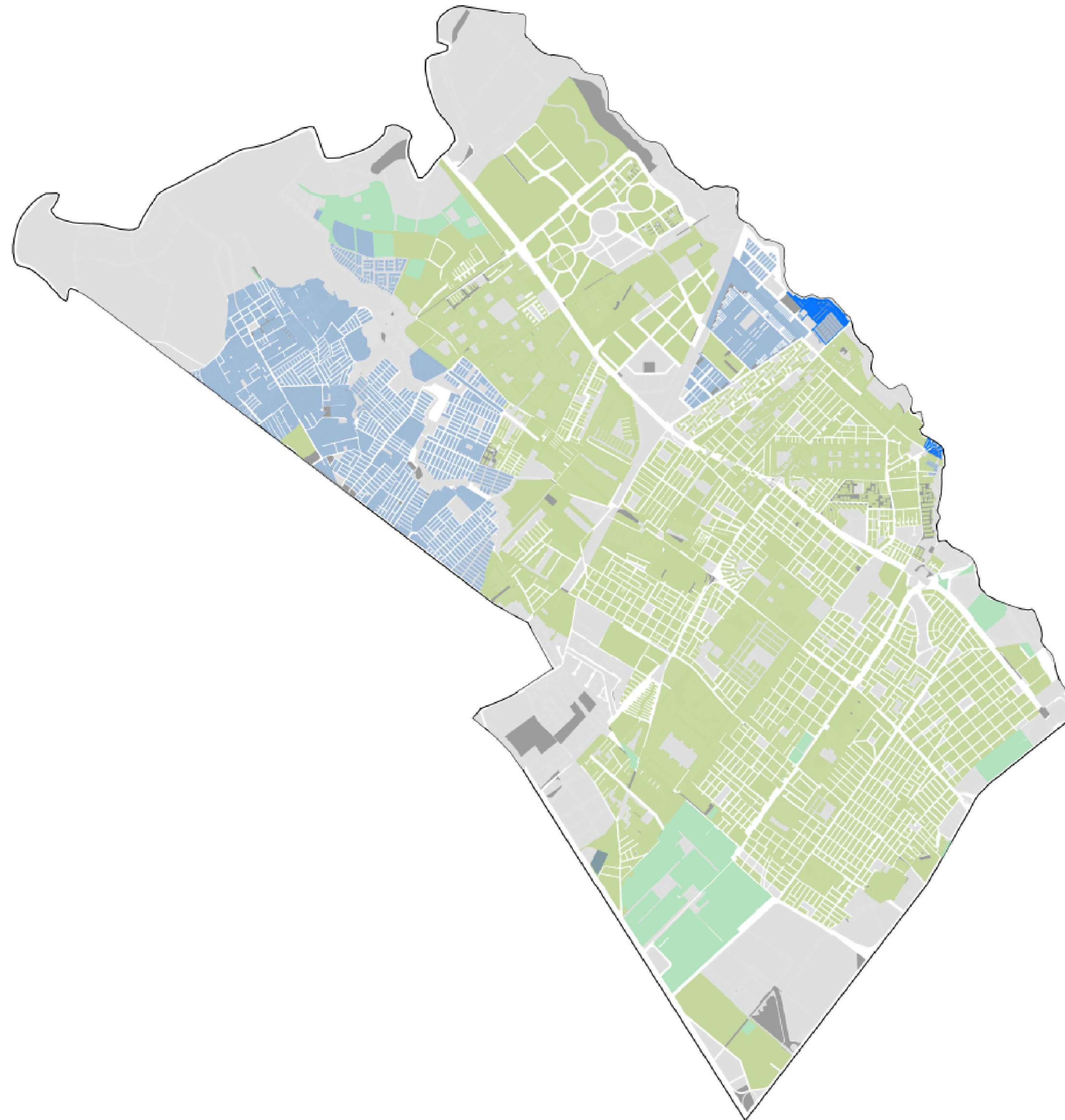

DIAGNÓSTICO DE ALTURAS

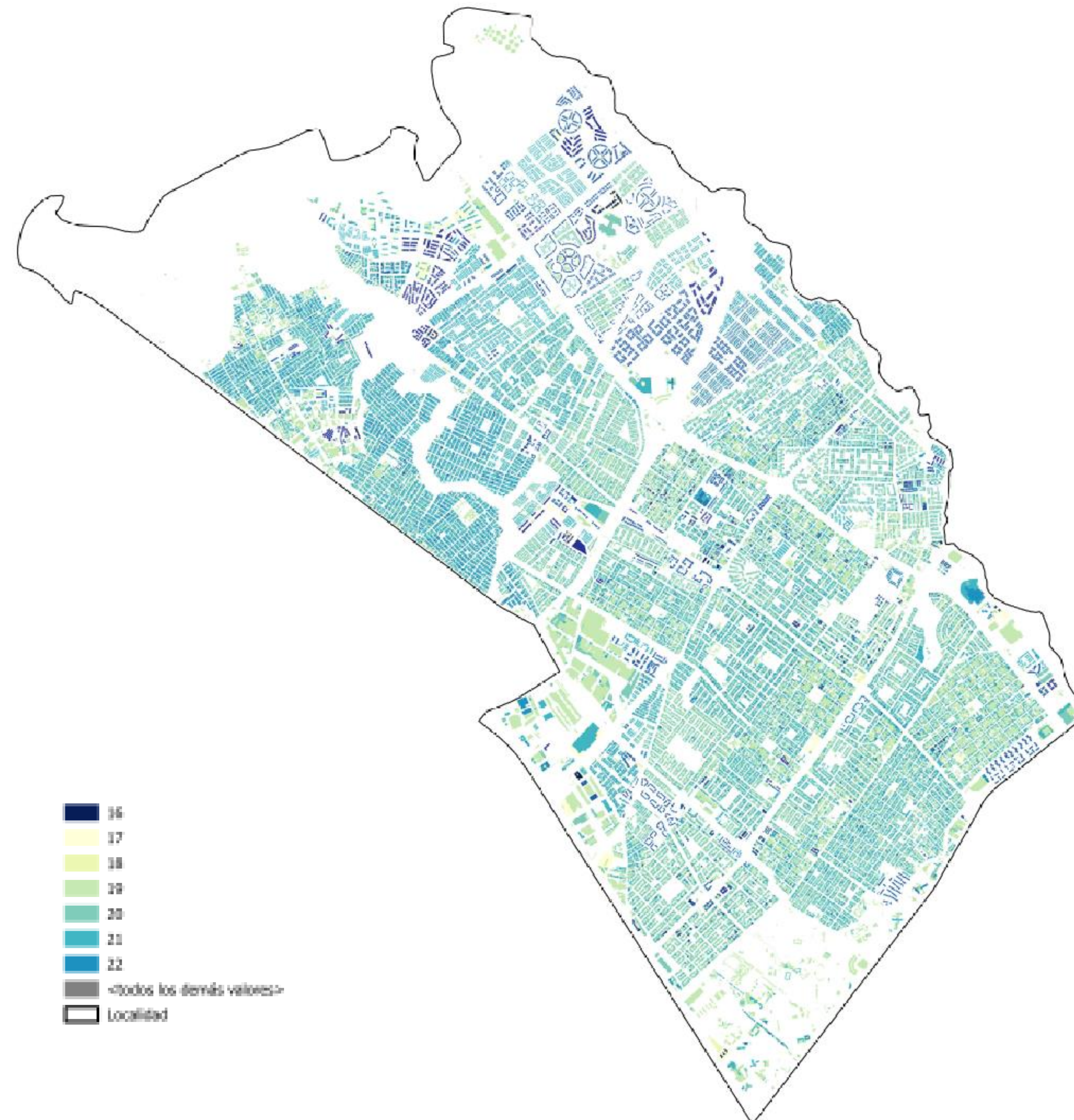

Legend

alturas_corte

Numero de pisos

0

<Null>

1

2

3

4

5

6

7

8

9

10

11

12

13

14

15

16

17

18

19

20

21

22

<todos los demás valores>

Localidad

