

Convenciones

- Área de intervención
- Área de influencia
- Área de influencia indirecta

Ubicación

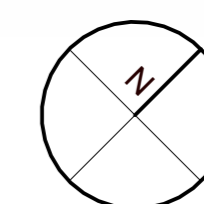

ESCALA:
1:100



1 PLANTA General
1 : 1000

PLANTA



ESCALA:
1:1000



Palacio de justicia

Iluminación

Ciclo parqueadero

Puntos wifi y recarga
eléctrica

Deposito de Basuras

Hidrante

Cicloestructura

Zonas de
Permanencias

Zonas de comercio
Informal

Plaza del Sol

Zonas de
Permanencias

Zonas de comercio
Informal

Calle 11

Hidrante

Calle 12

2

Planta Calle 11 y 12

1 : 200

Calle 11 a
Calle 12

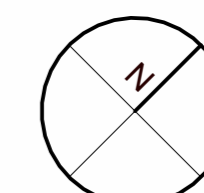

ESCALA:

1 :
200



3 Planta Calle 12 y 12B

1 : 200

Calle 12 a
Calle 12b

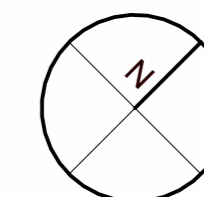

ESCALA:

1 :
200

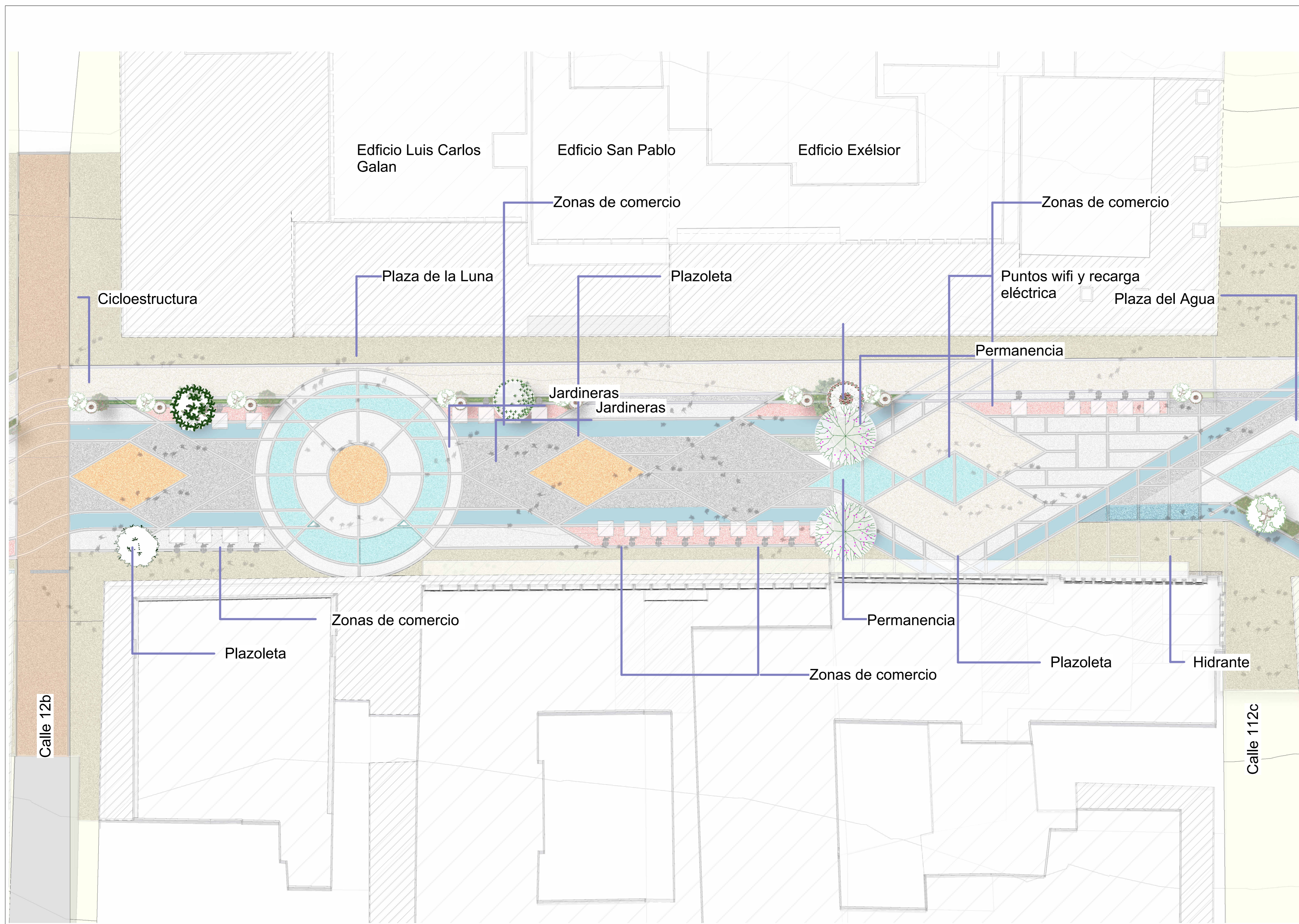

4 Planta Calle 12B y 12C
1 : 200

Calle 12b a
Calle 12c

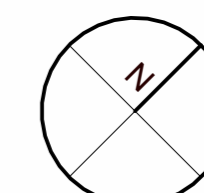

ESCALA:
1 :
200

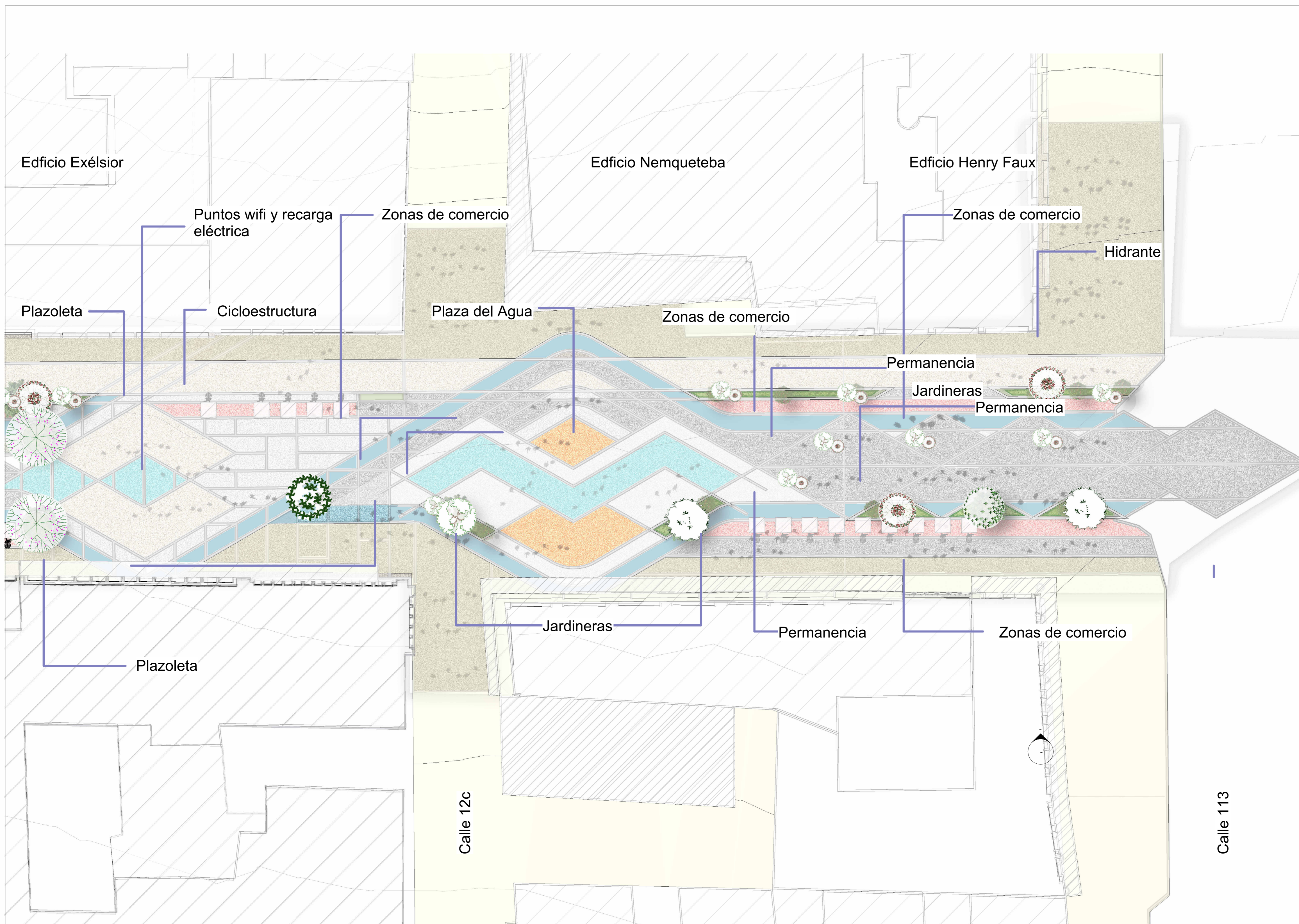

4

Planta Calle 12C y 13

1 : 200

Calle 12c a
Calle 13

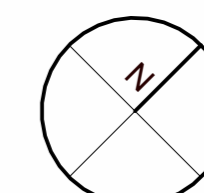

ESCALA:

1 :
200

TITULO DEL PROYECTO:

REGENERACIÓN URBANA.
CARRERA SÉPTIMA
FASE 1

BOGOTÁ 2023

CONVENCIONES:



CURSO:

ENFASIS DE GRADO
2024

CONTIENE:

Detalle

OBSERVACIONES:

ESCALA:
Autor

FECHA DE ENTREGA:

25 DE NOVIEMBRE
DE
2024

REVISIÓN:

PLANCHA:

A-001

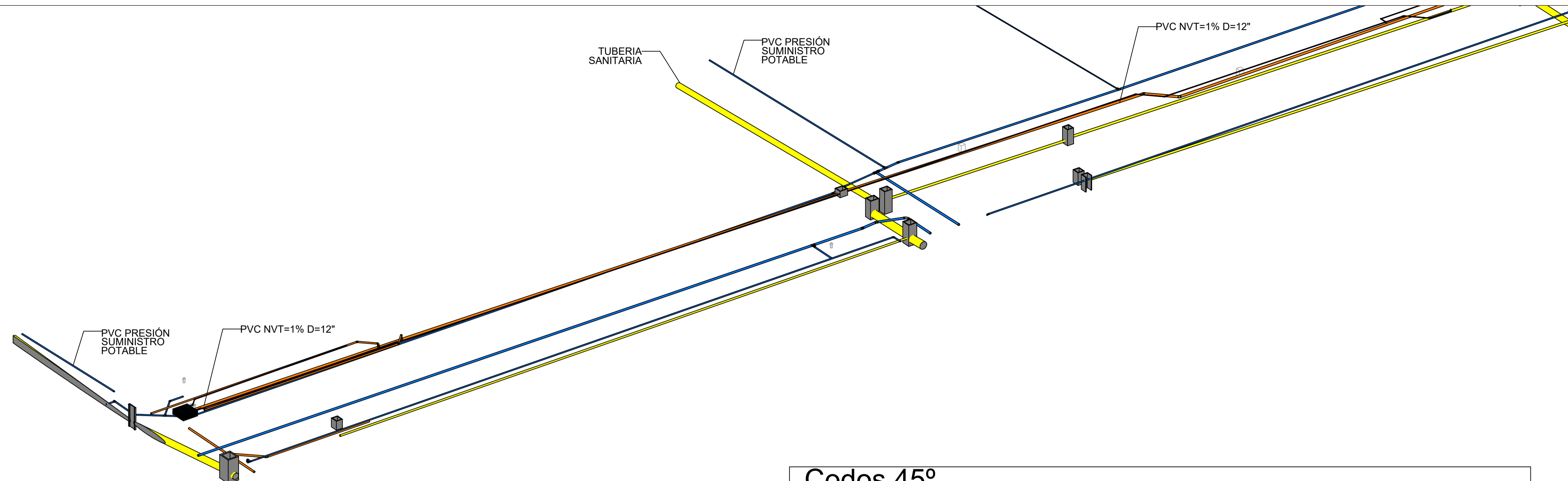

Codos 45°														
Codos 90°												Cruz		
Tee's												T.Union		

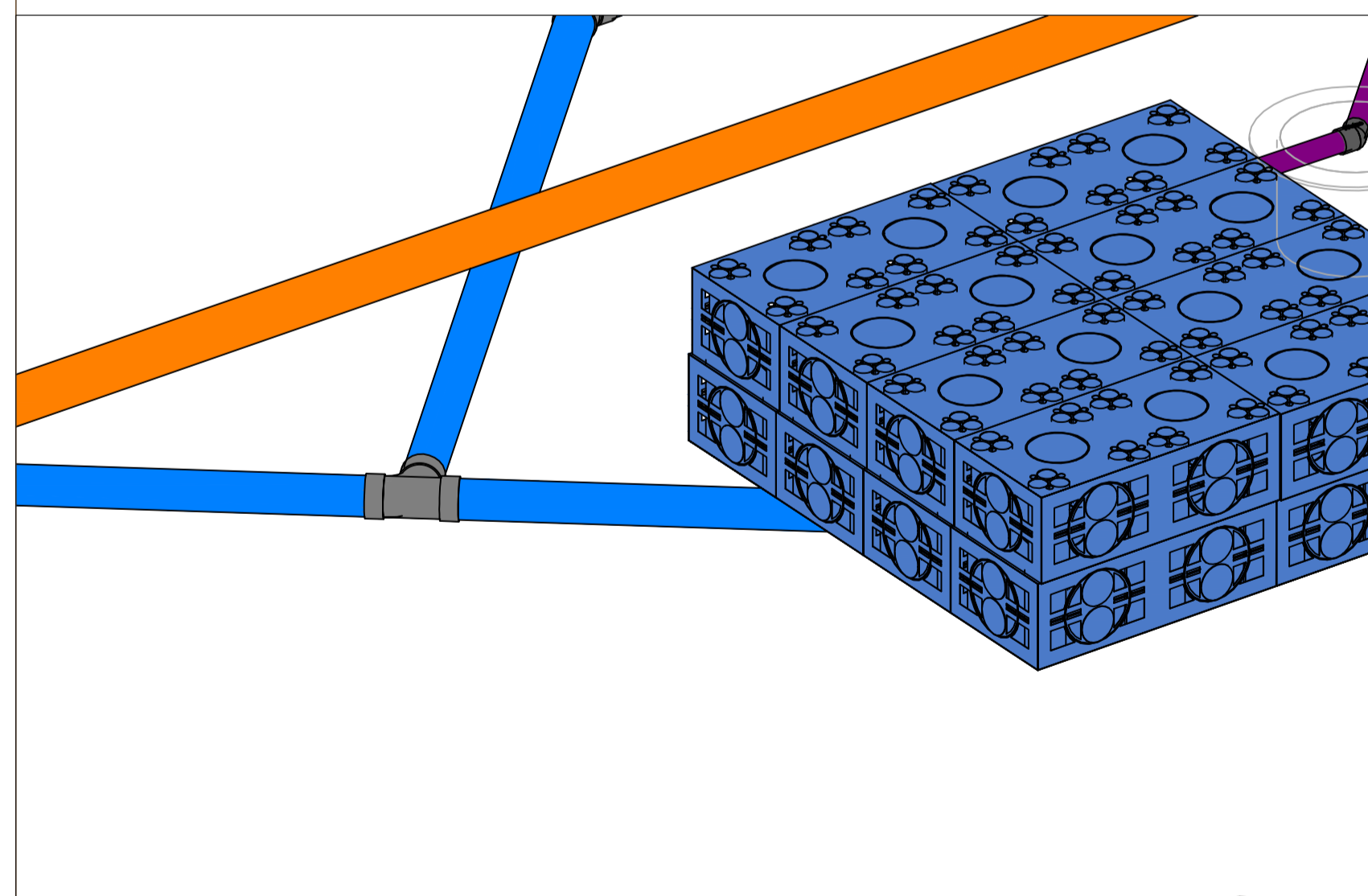

D1 DETALLE DE ACUA CELL
ESCALA 1:20
0 0.4 0.8 1.2 1.6 2.0 m
ESCALA A 120

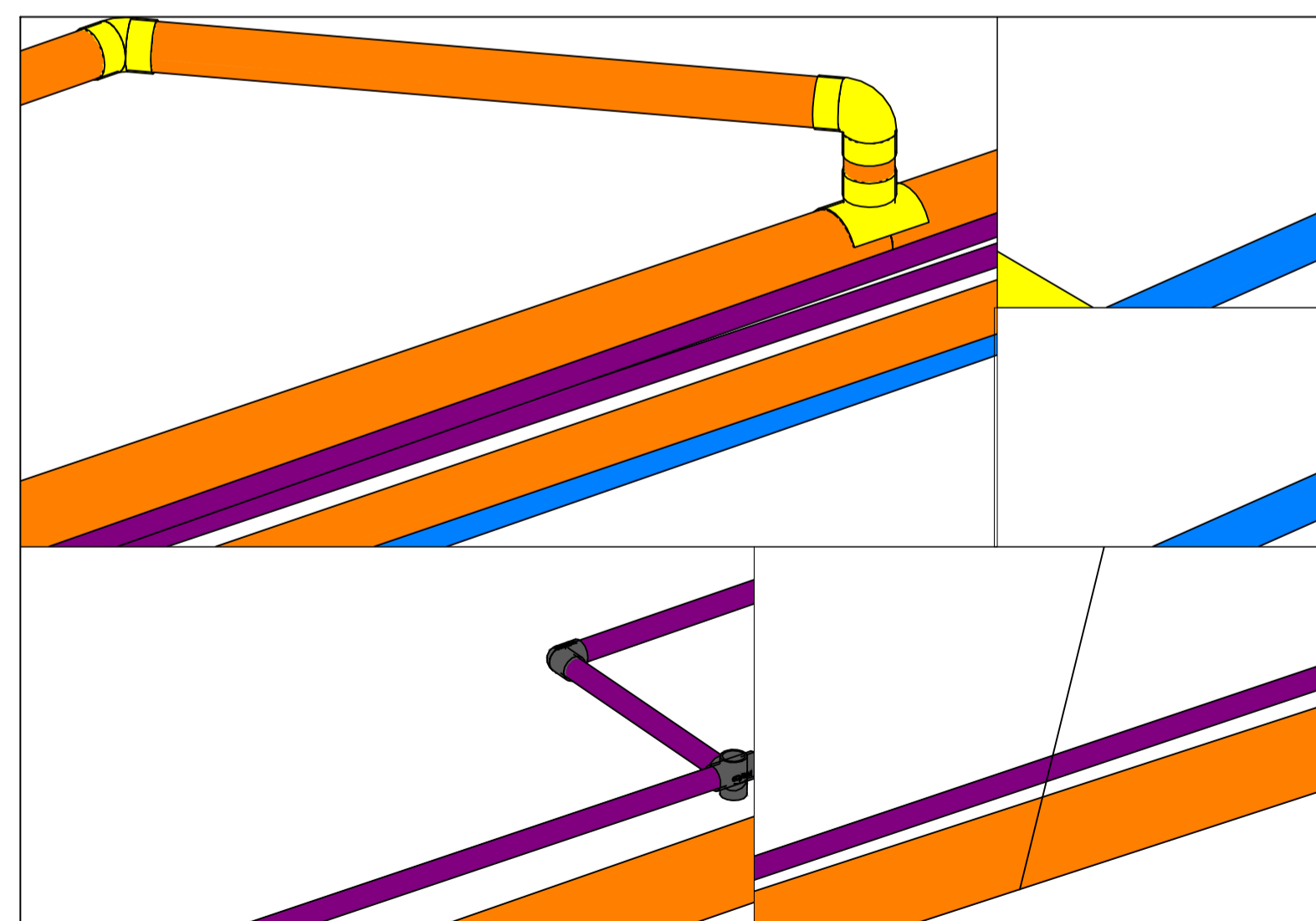

D2 DETALLE CONEXIONES HIDRAULICAS
ESCALA 1:20
0 0.4 0.8 1.2 1.6 2.0 m
ESCALA A 120

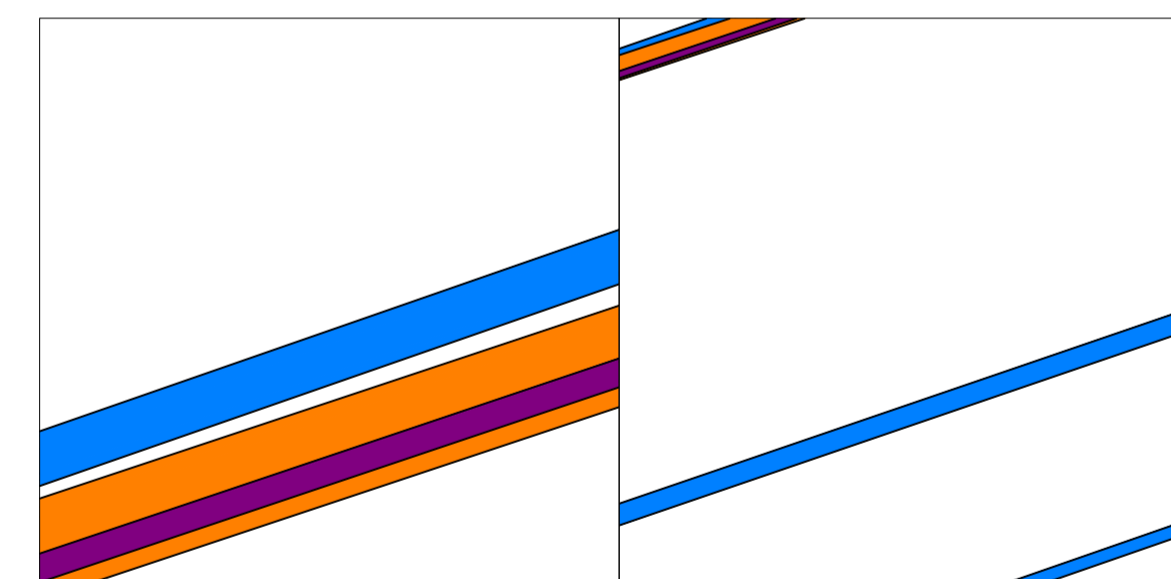

D3 DETALLE CAJAS DE INSPECCIÓN
ESCALA 1:20
0 0.4 0.8 1.2 1.6 2.0 m
ESCALA A 120

Detalle
tuberías

ESCALA:

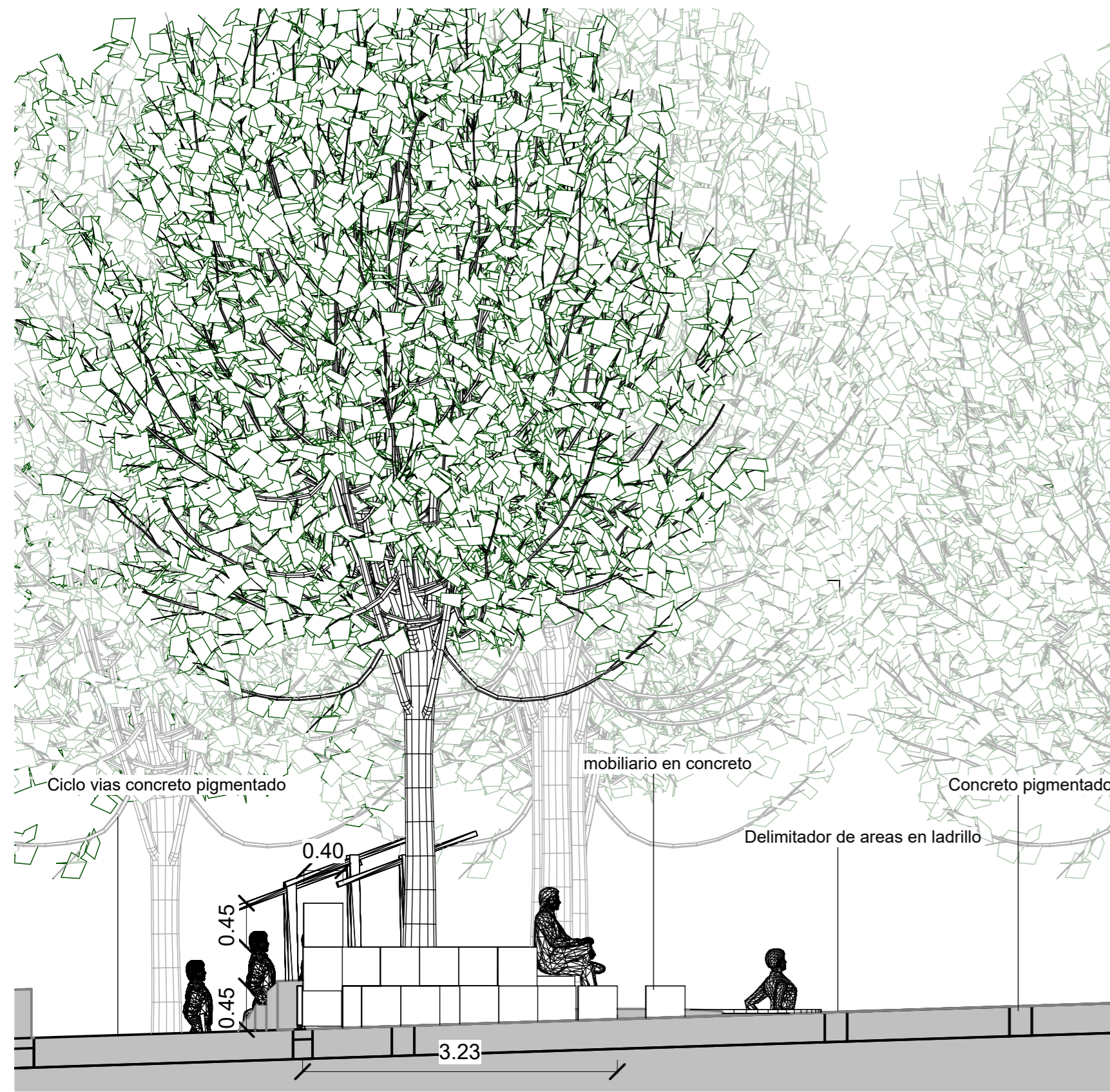

1 **Mobiliario fijo calle 12**
1 : 50



2 **Mobiliario vendedores**
1 : 50



3 **Mobiliario fijo jardines**
1 : 100



4 **Mobiliario fijo calle 12 b**
1 : 100

Detalles

ESCALA:
Como se indica

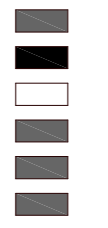

	
FACULTAD DE ARQUITECTURA ENFASIS DE GRADO 2024	
TITULO DEL PROYECTO: REGENERACIÓN URBANA. CARRERA SÉPTIMA FASE 1 BOGOTÁ 2023	
CONVENCIONES: 	
CURSO: ENFASIS DE GRADO 2024	
CONTIENE: Detalles	
OBSERVACIONES:	
ESCALA: Autor Como se indica	
FECHA DE ENTREGA: 25 DE NOVIEMBRE DE 2024	
REVISIÓN:	PLANCHA: A-001

TRAMO 1

TRAMO 2

Codos 45°

Codos 90°

Tee's

Cruz

T.Union

CONVENCIONES:

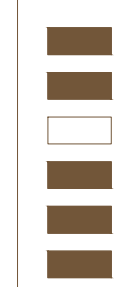

CURSO:

ENFASIS DE GRADO 2024

CONTIENE:

Planta

OBSERVACIONES:

ESCALA: Autor

FECHA DE ENTREGA:

25 DE NOVIEMBRE DE 2024

REVISIÓN:

PLANCHA:

A-001

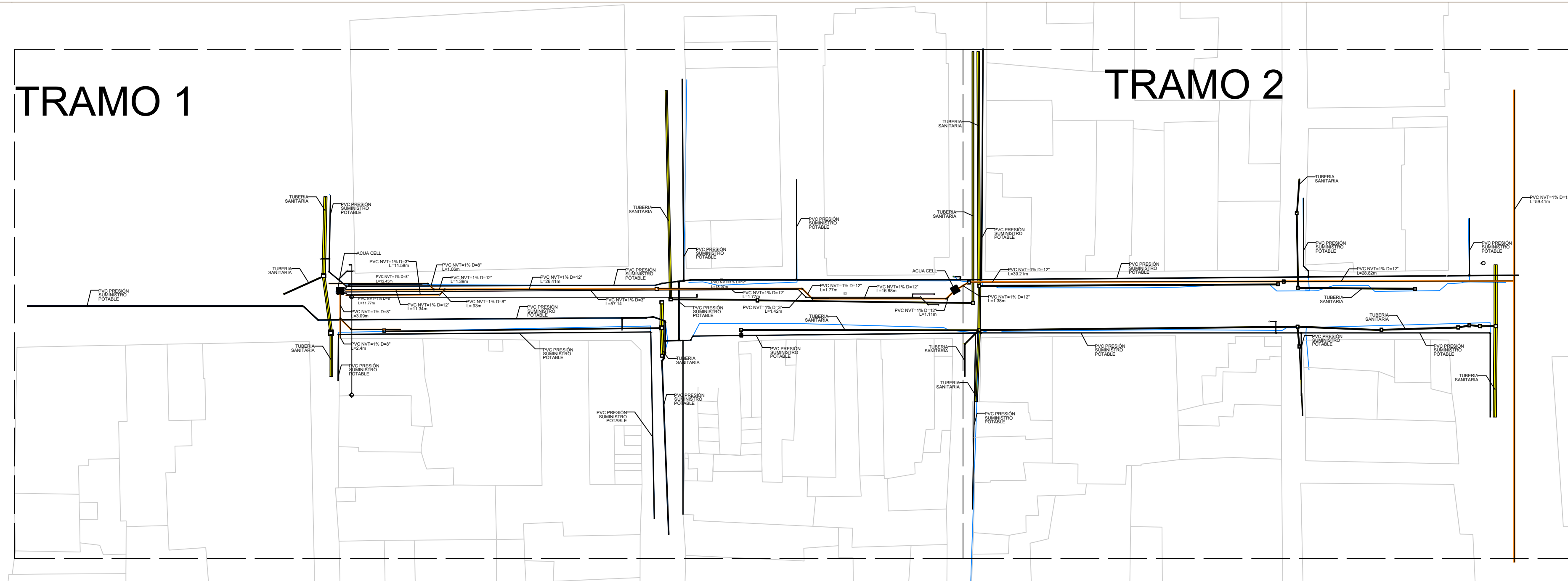

G1 PLANTA GENERAL INSTALACIONES ESCALA 1:300 ESCALA A 1:400

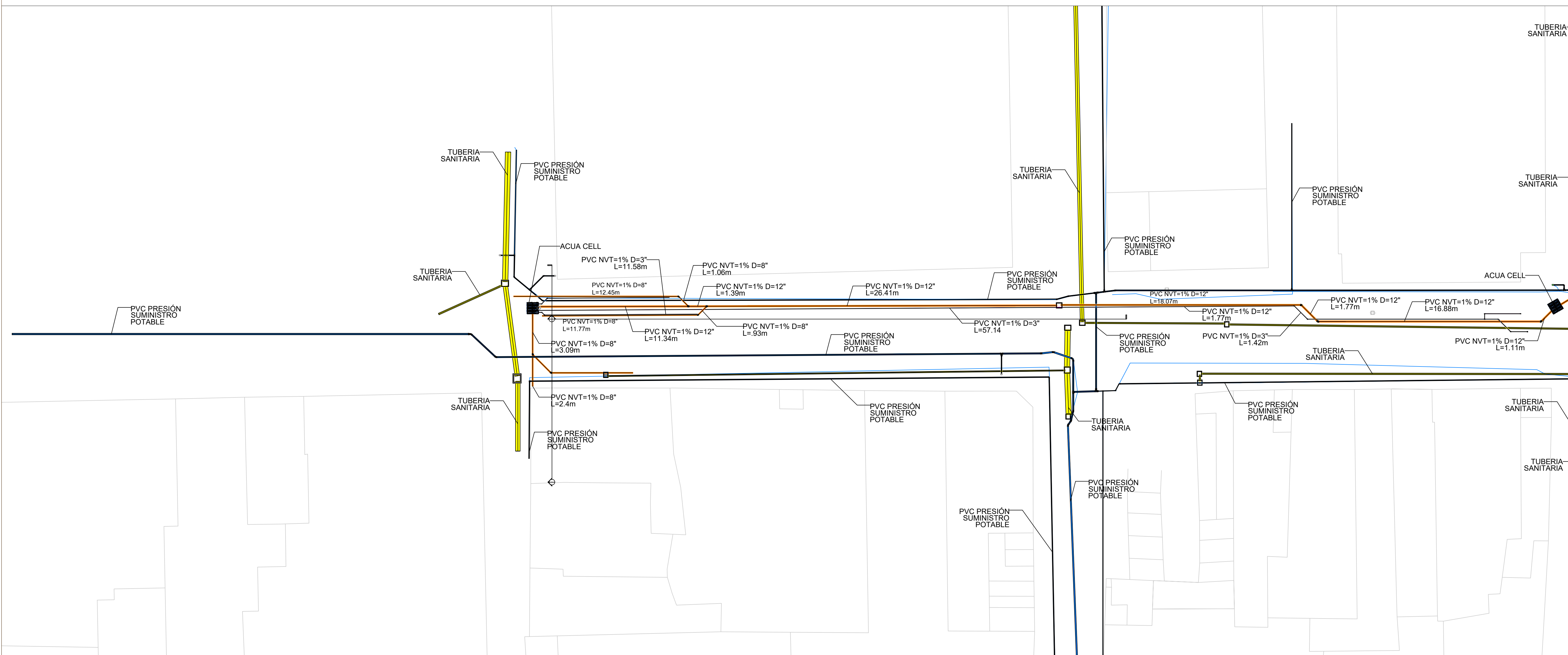

G1 PLANTA TRAMO 1 ESCALA 1:150 ESCALA A 1:150

Planta tramo 1

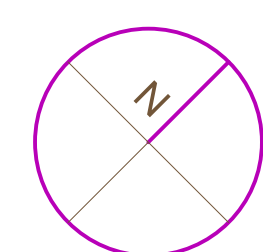

ESCALA:

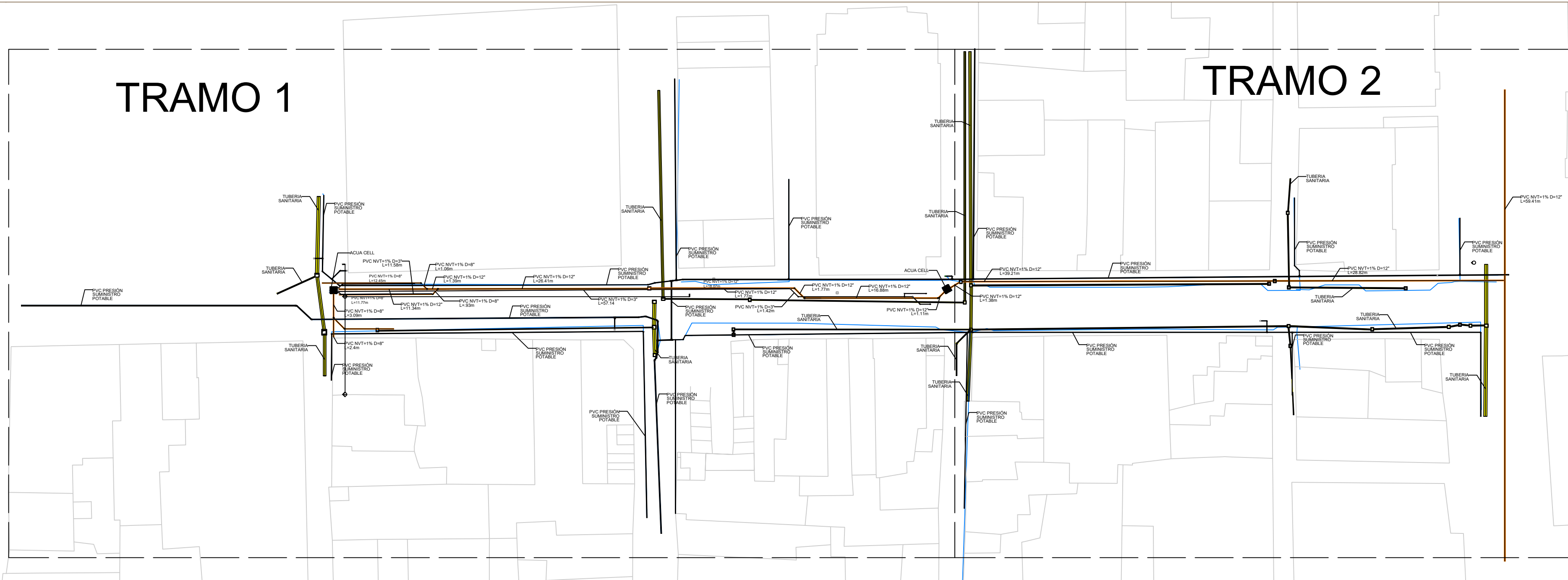

Codos 45°		Cruz	
Codos 90°		T.Union	
Tee's			

G1 PLANTA GENERAL INSTALACIONES
 ESCALA: 1:300
 0 8 16 24 32 40 m
 ESCALA A: 1:400



G1 PLANTA TRAMO 2
 ESCALA: 1:150
 0 3.0 6.0 9.0 12 15 m
 ESCALA A: 1:150

Planta tramo 2

2

ESCALA:

CONVENCIONES:

█	
█	
█	
█	

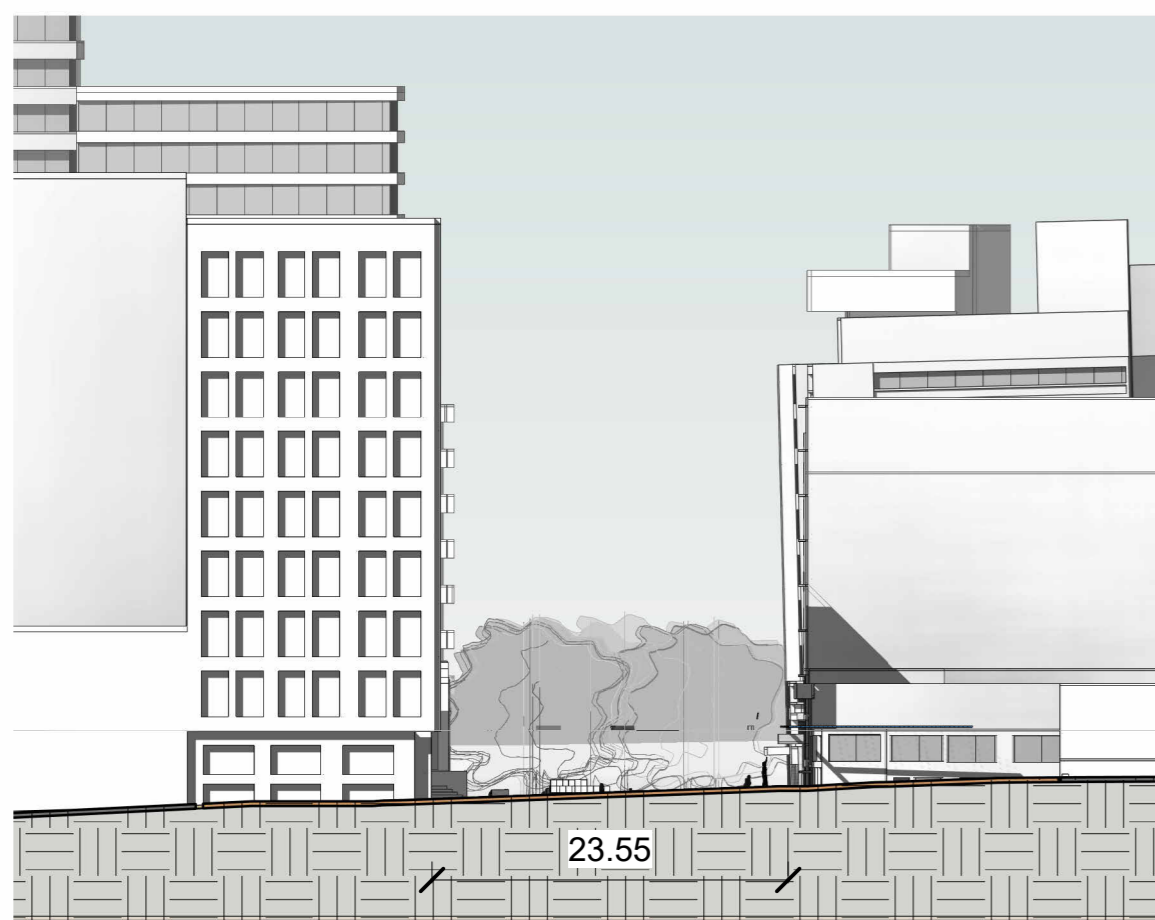

Perfil A-A V4 Carrera 7 entre Calle 12 y 12 b

1 Corte transversal calle 12
1 : 500

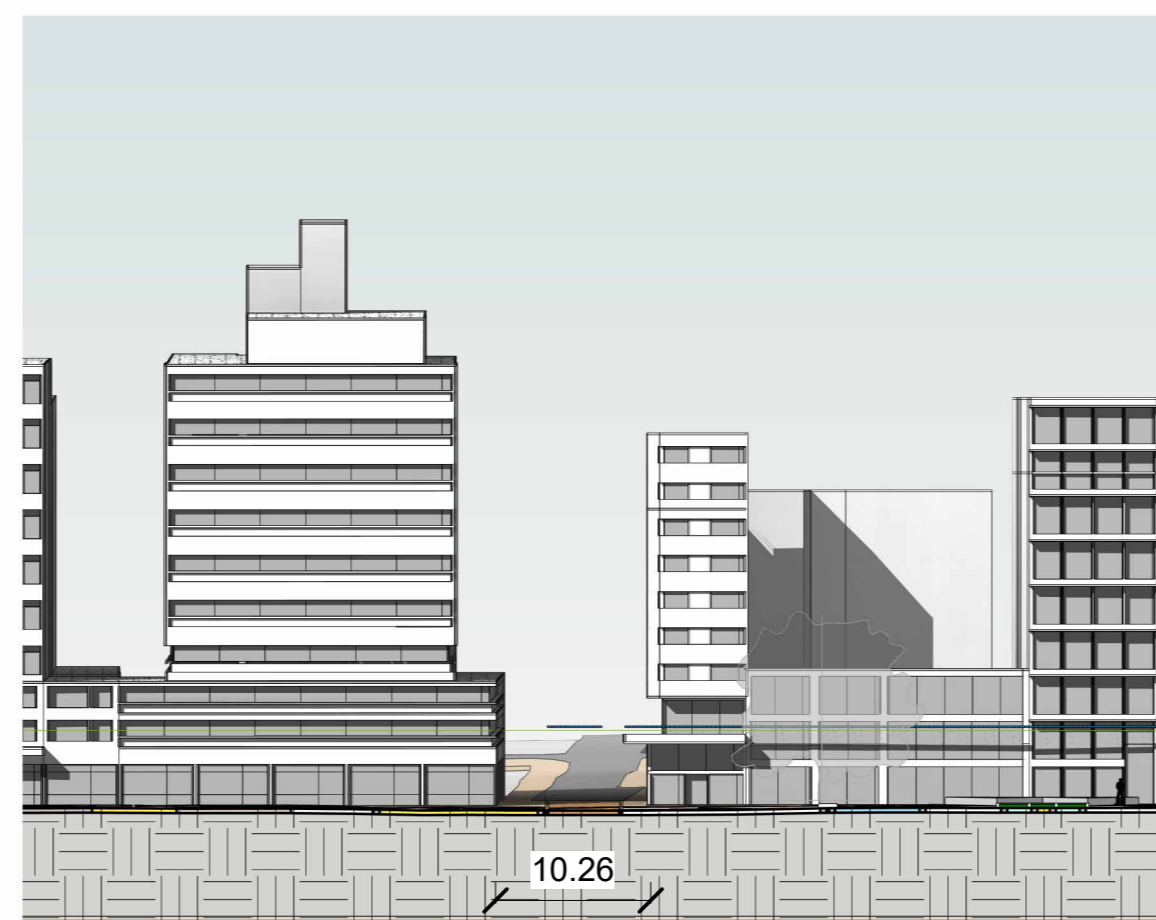

Perfil B-A V8 calle 12b entre carrera 7 y 8

2 Perfil calle 12 b
1 : 500

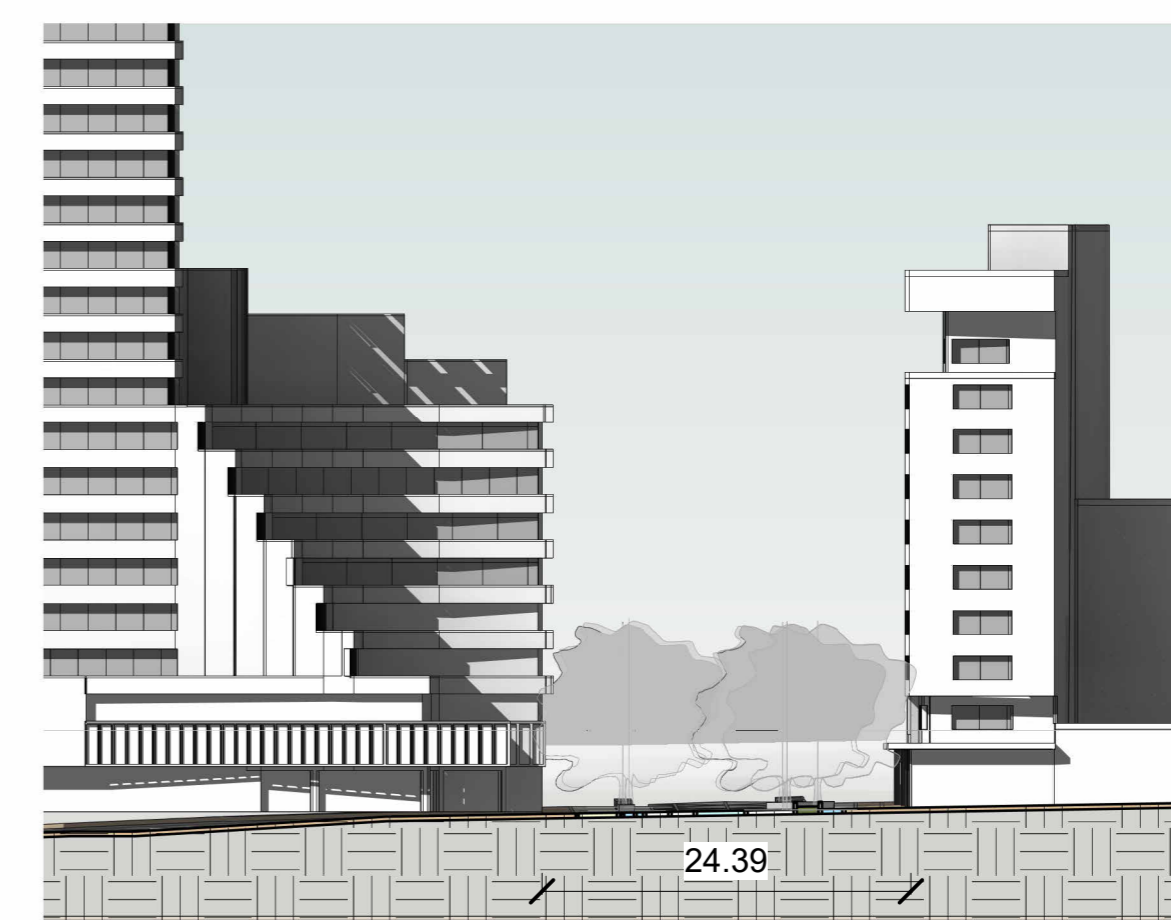

Perfil A-B V4 Carrera 7 entre calle 12c y 13

3 Corte Transversal calle 12c
1 : 500

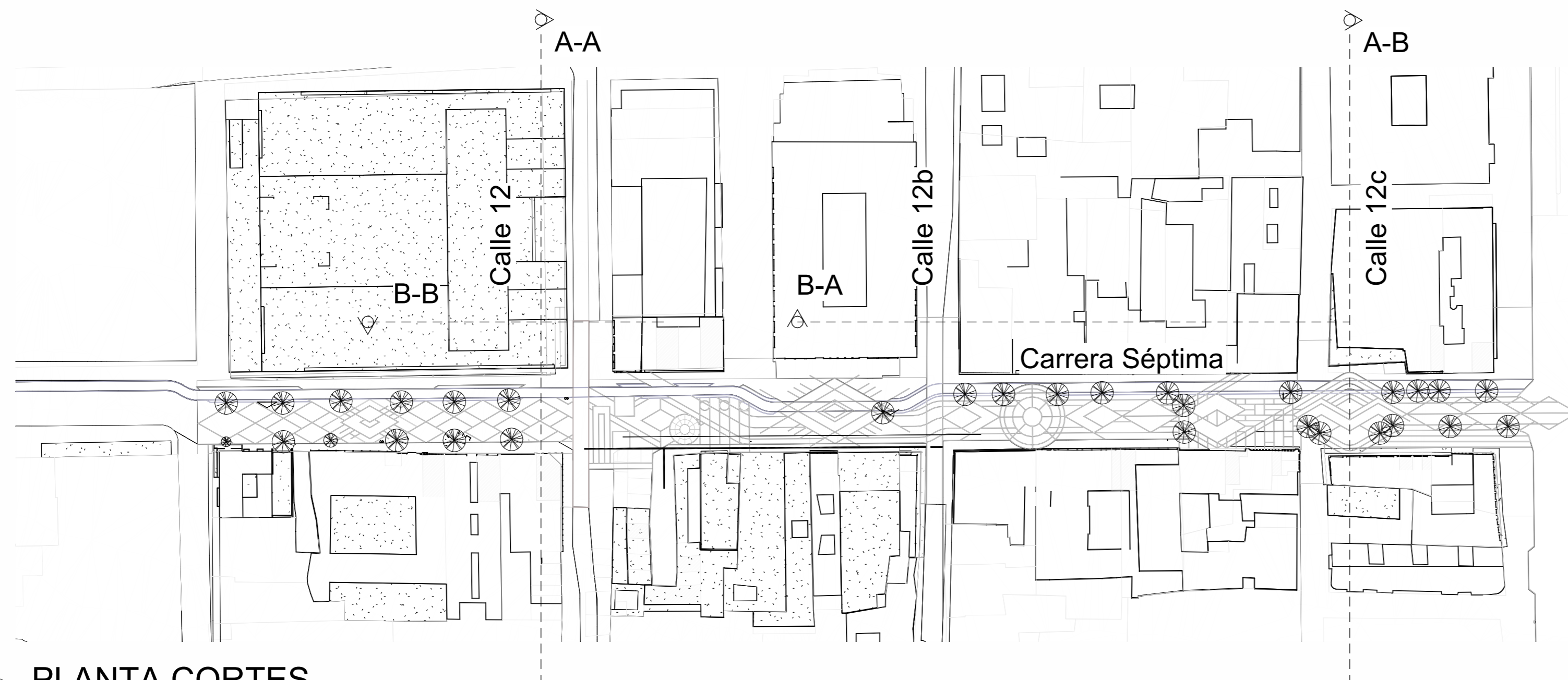

7 PLANTA CORTES
1 : 1200

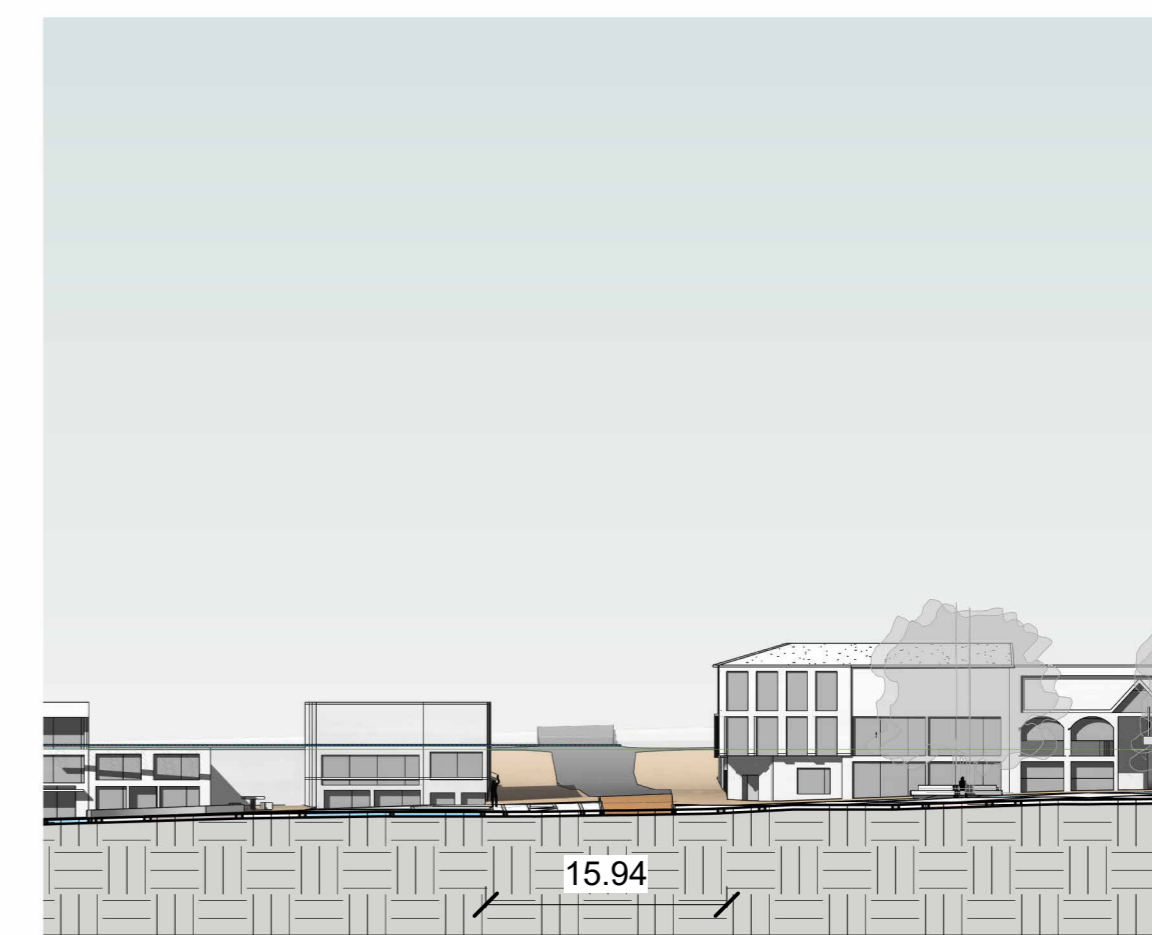

Perfil B-B V6 Calle 12 entre Carrea 7 y 6

5 Perfil calle 12
1 : 500



6 Corte Longitudinal
1 : 1000

Perfiles
Viales

ESCALA:
1:1000

