



# VIVIENDA RURAL CAMPESINA EN GUAYATÁ

"COMO APOYO AL DESARROLLO AGRÍCOLA Y EDUCATIVO"



# DISEÑO RURAL

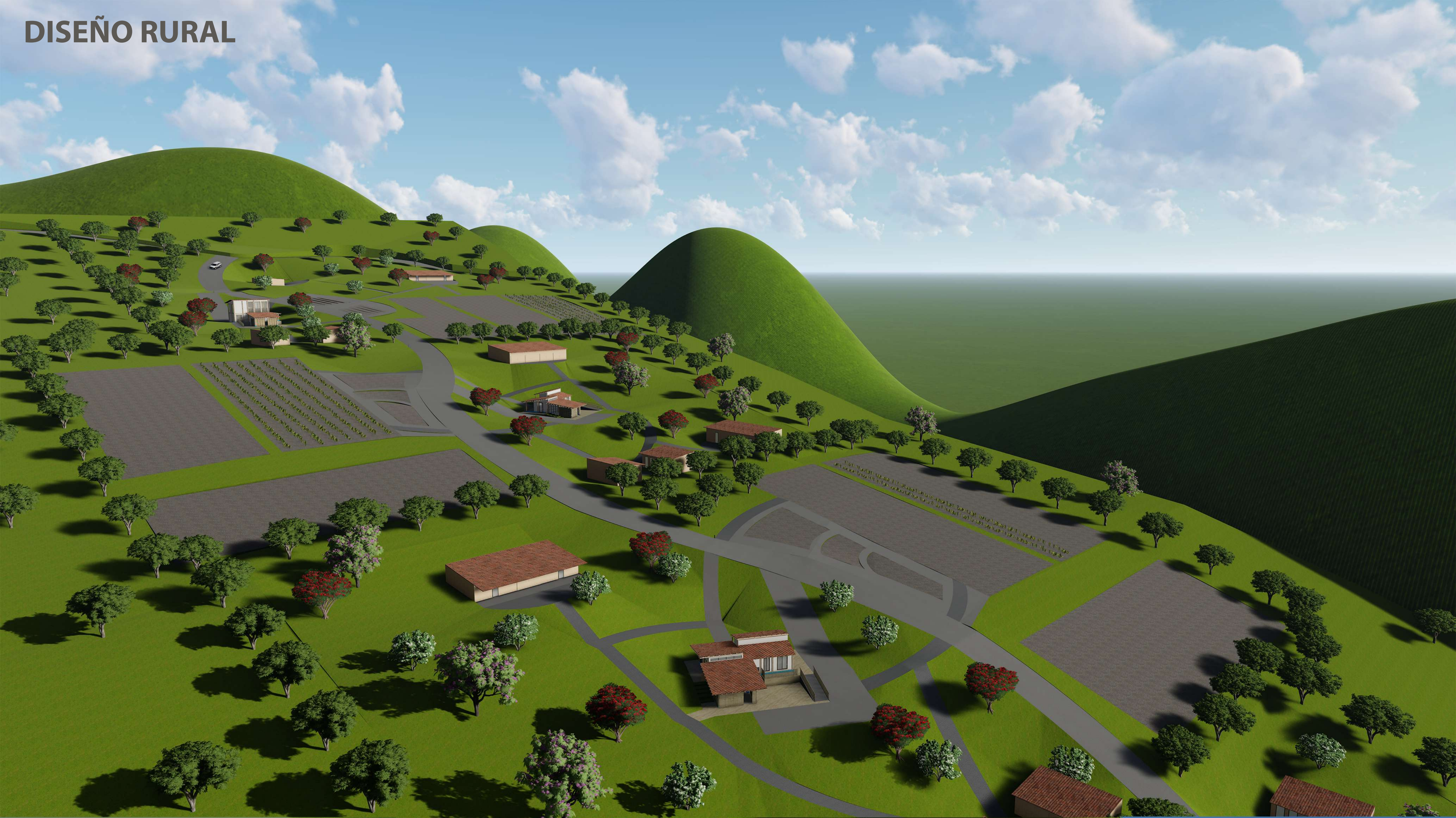

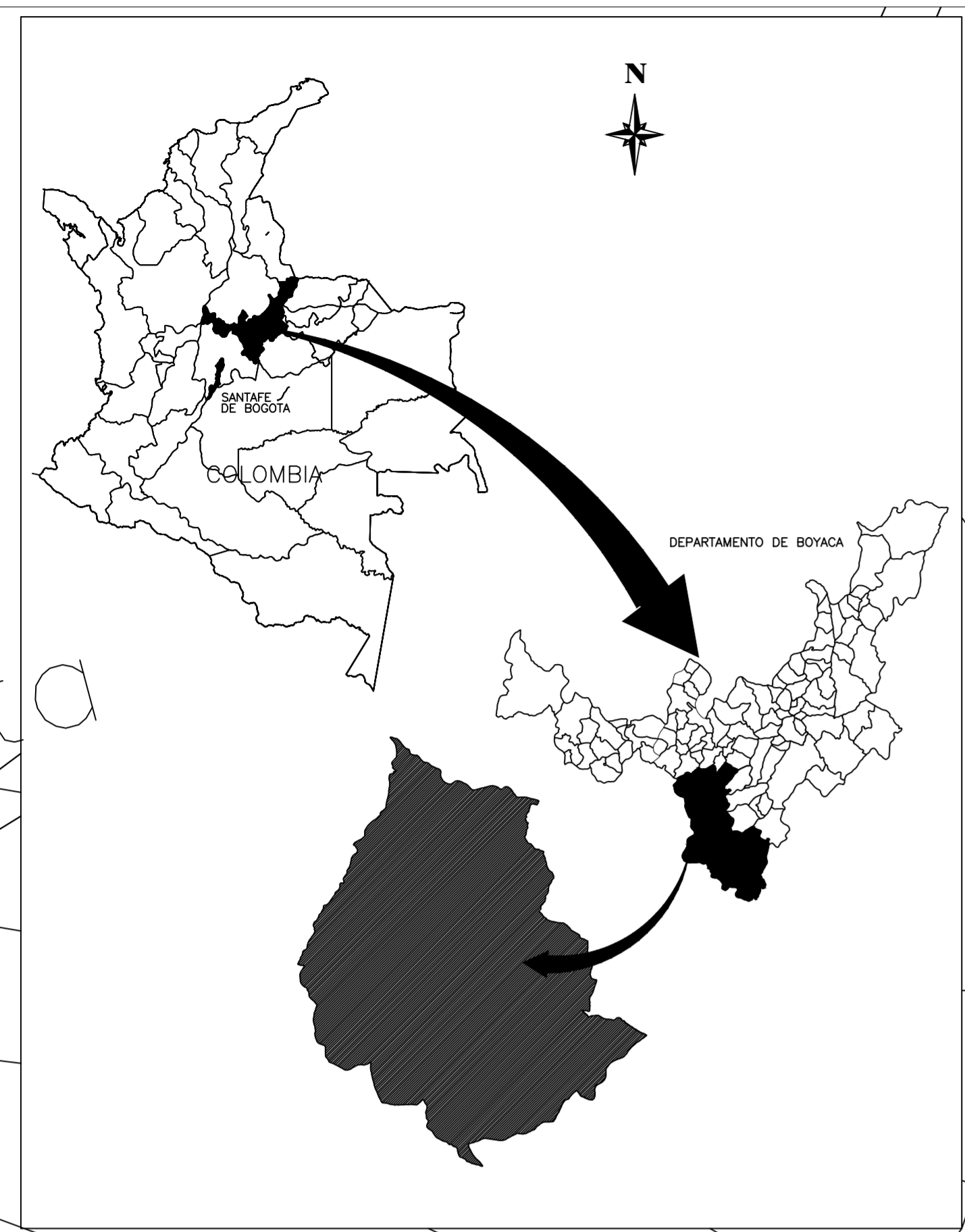

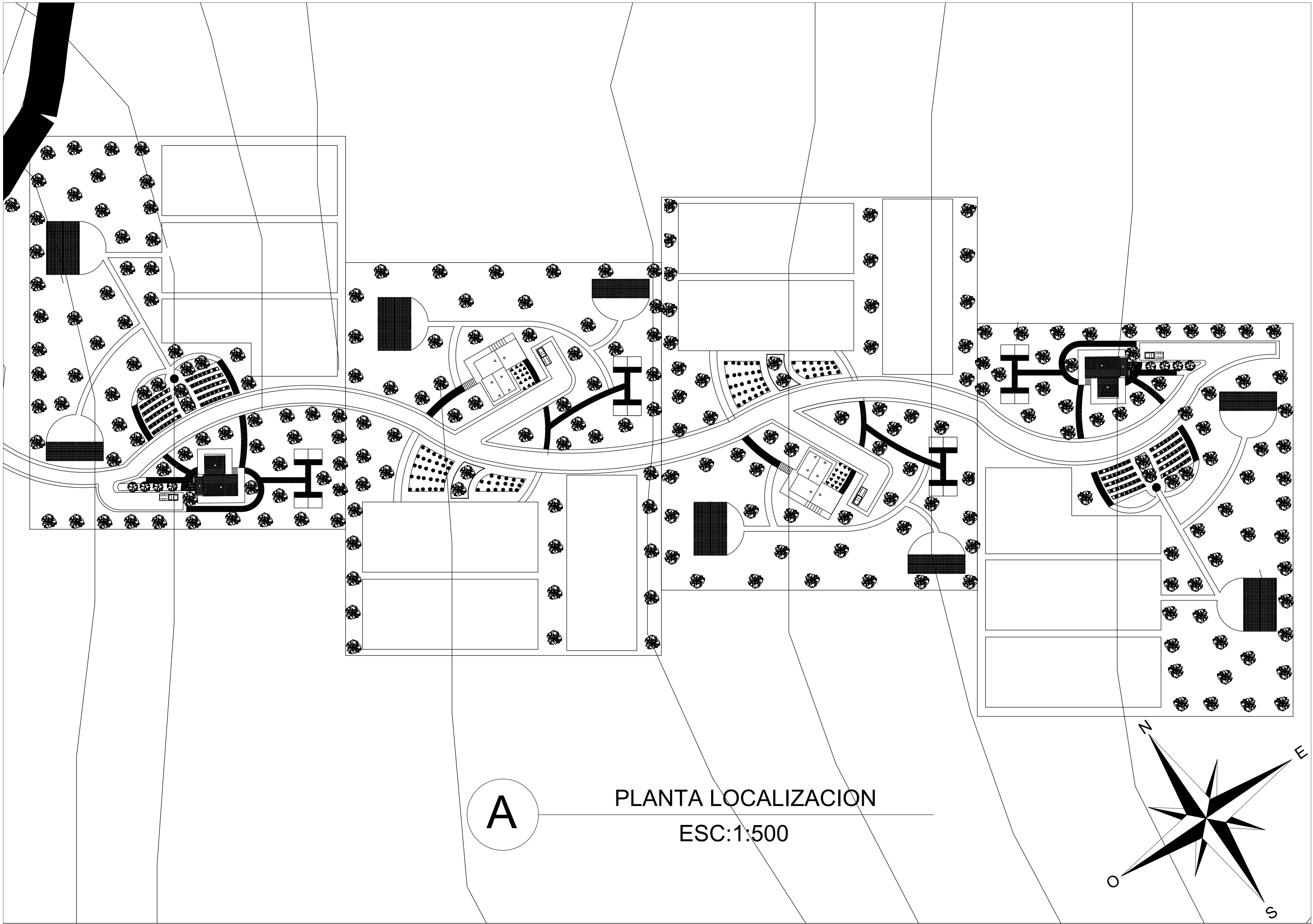

A

PLANTA LOCALIZACION

ESC:1:500

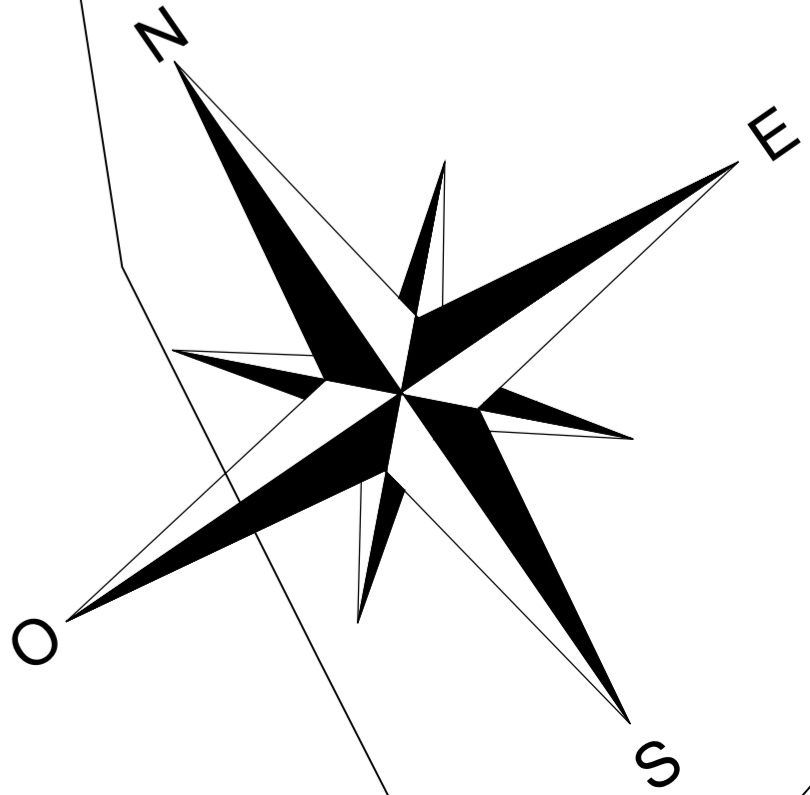

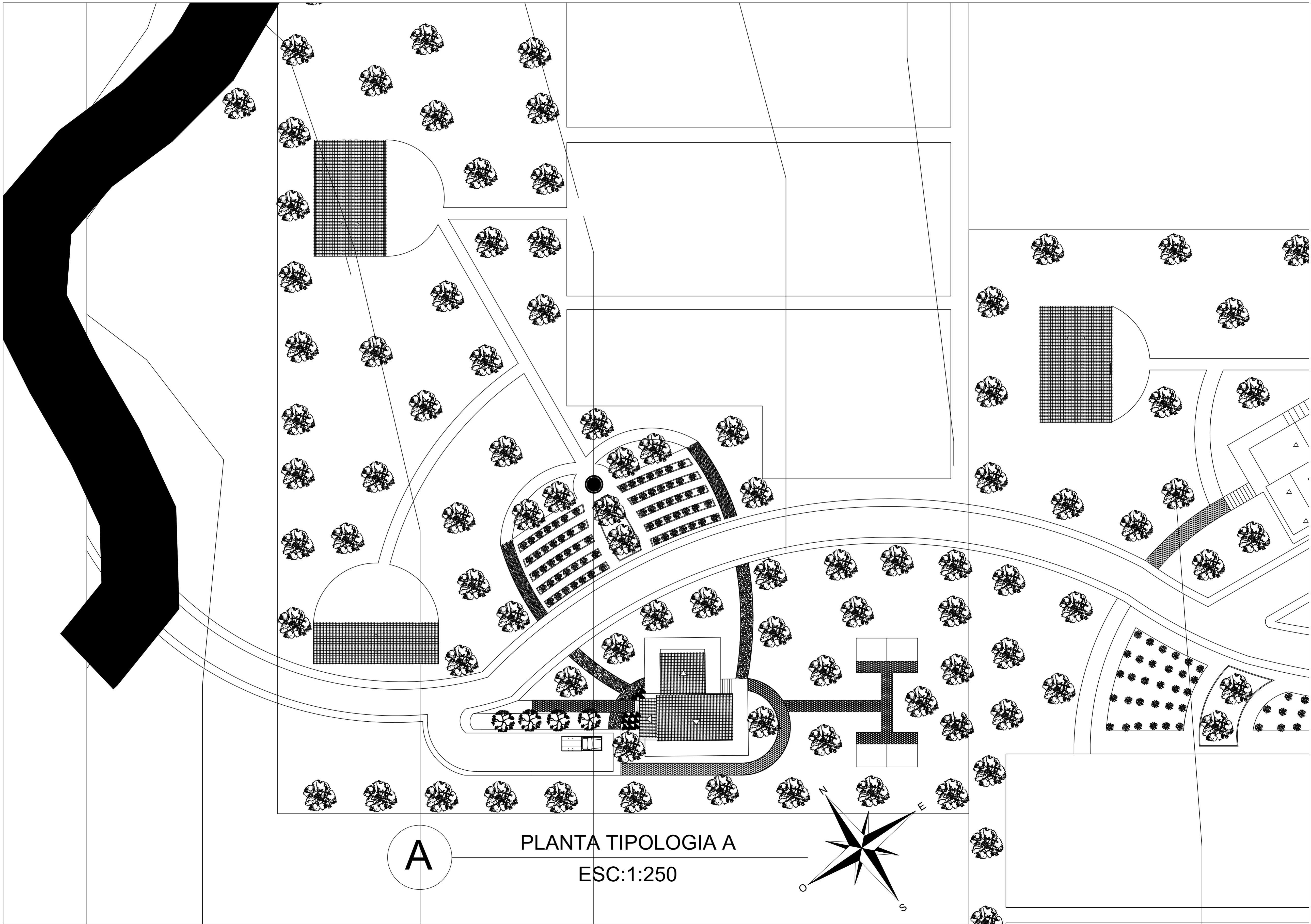

A

PLANTA TIPOLOGIA A

ESC:1:250

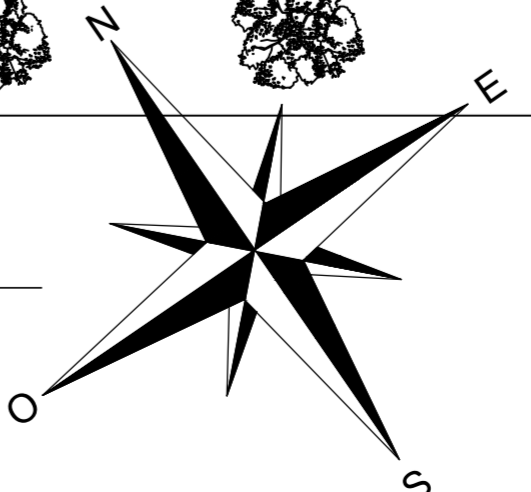

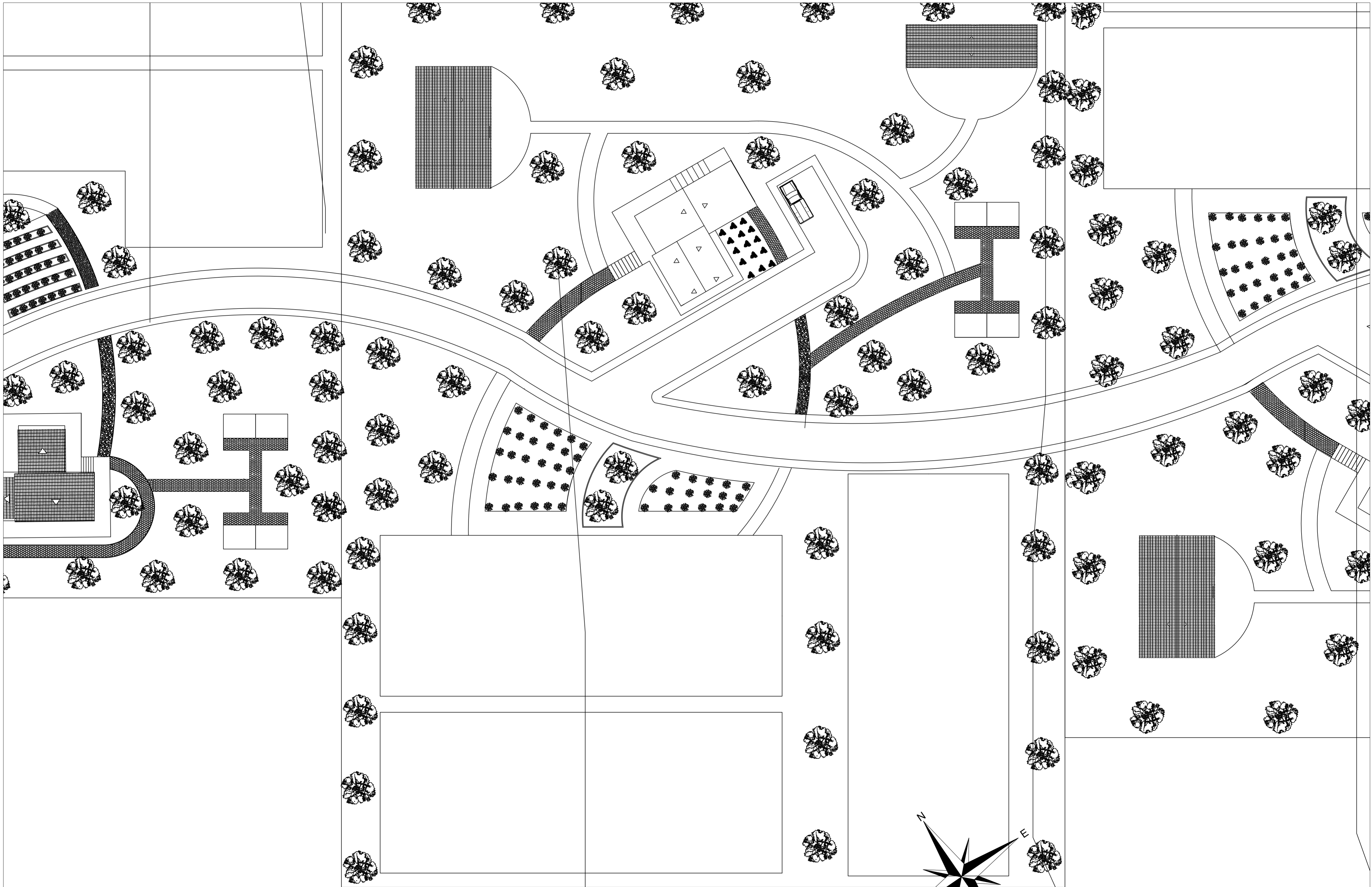

A

PLANTA TIPOLOGIA B

ESC:1:250

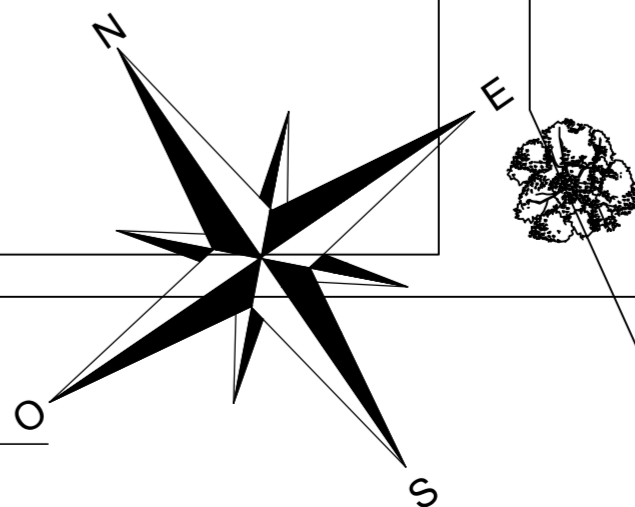

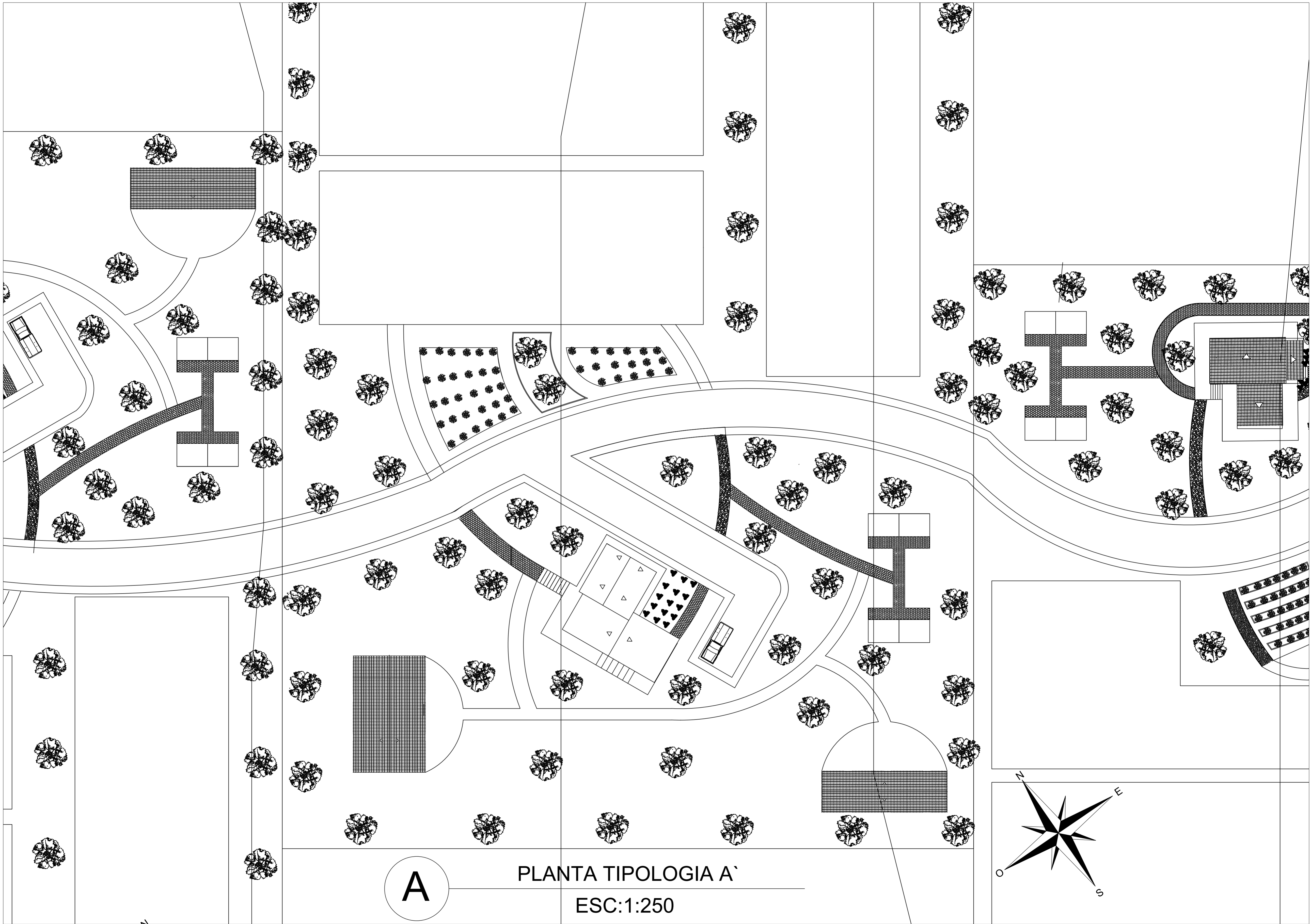

A

PLANTA TIPOLOGIA A'

ESC:1:250

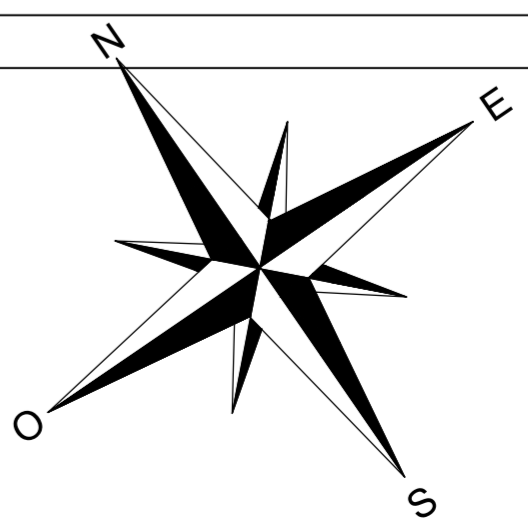

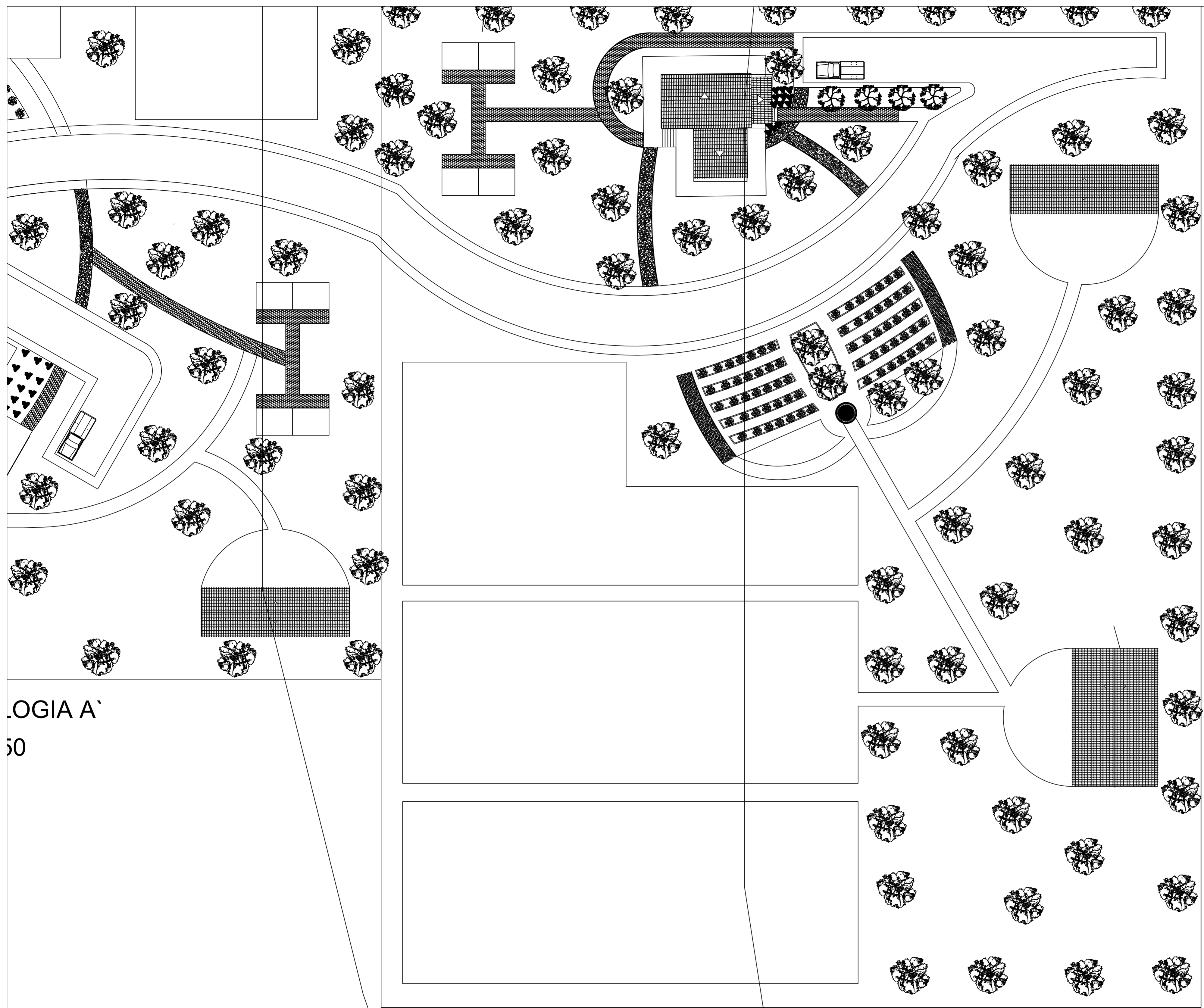

LOGIA A'  
50

A

PLANTA TIPOLOGIA B'

ESC:1:250

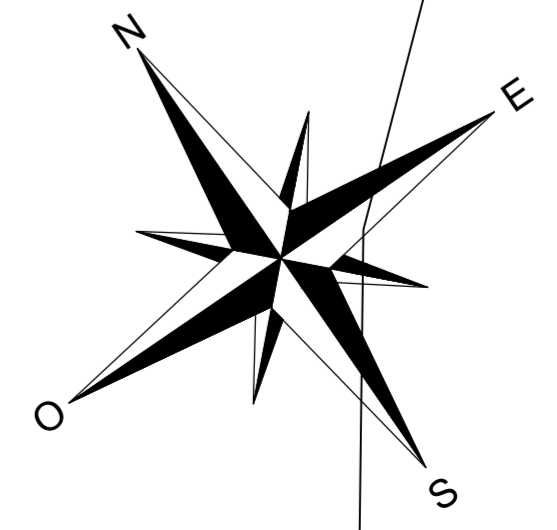

# PROTOTIPO I



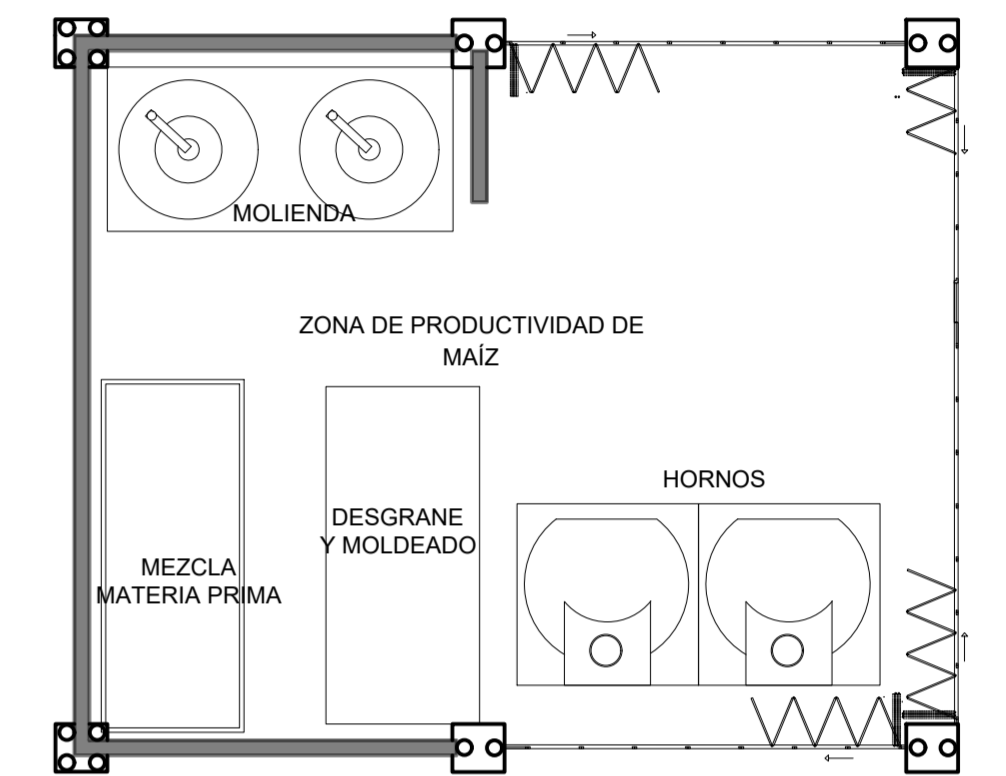
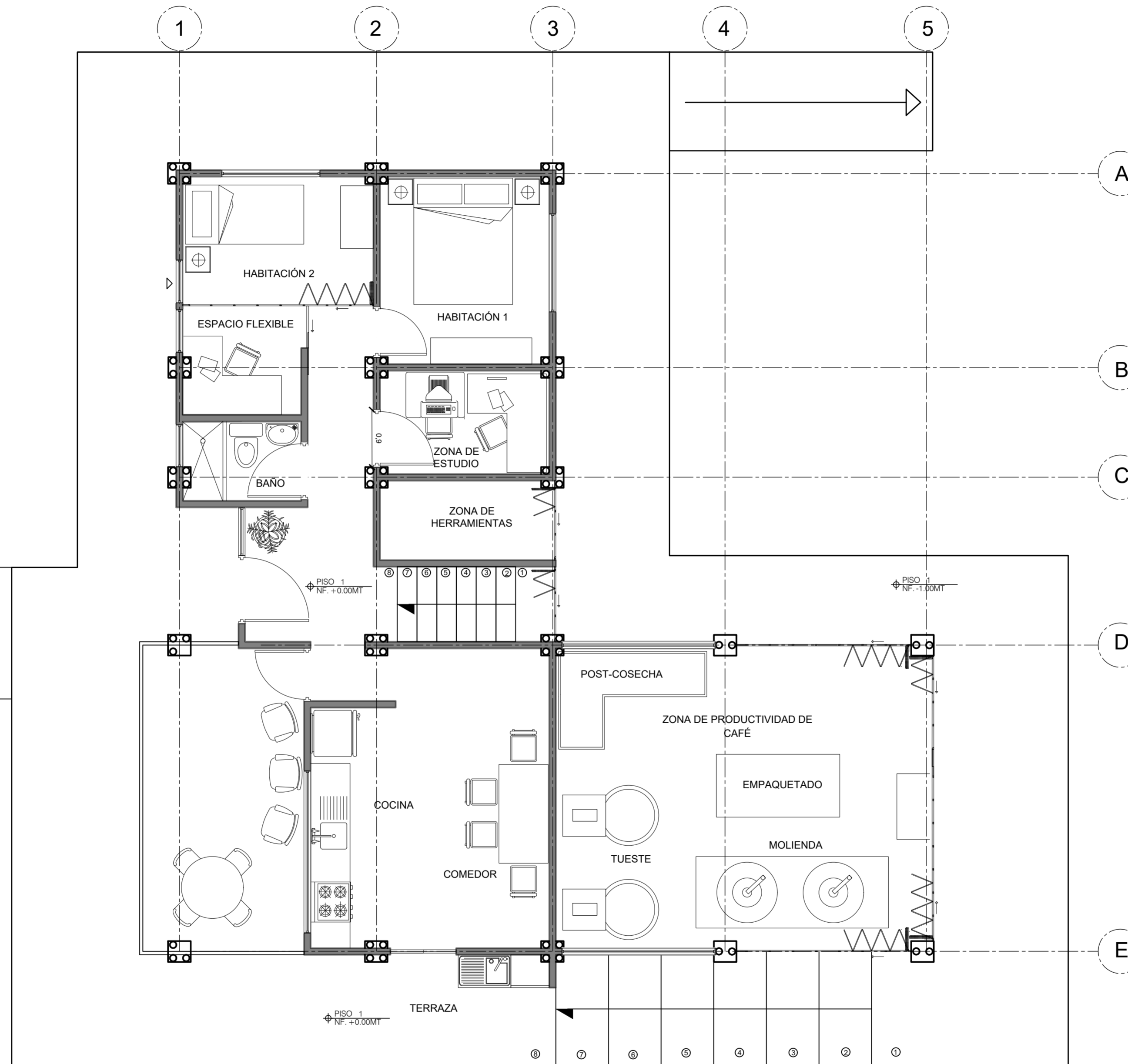
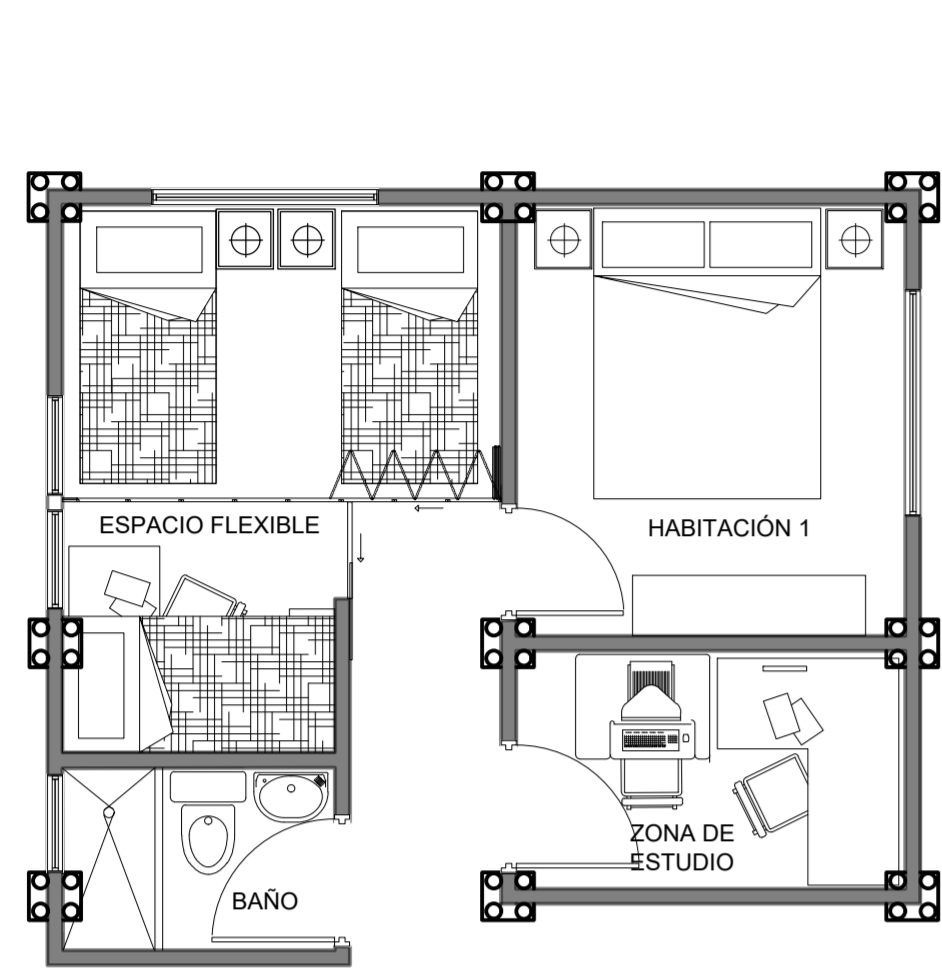

A PLANTA ARQUITECTÓNICA  
ESC:1:50

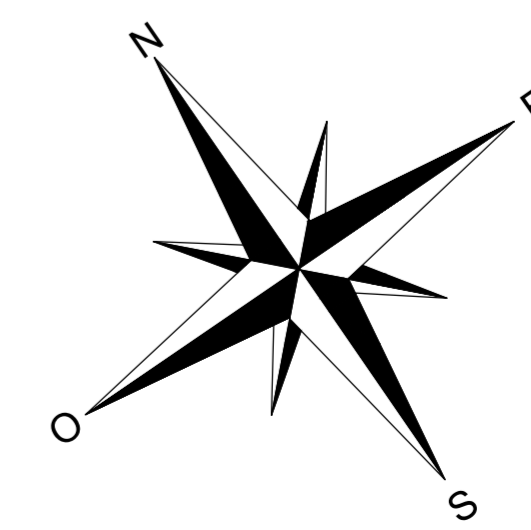



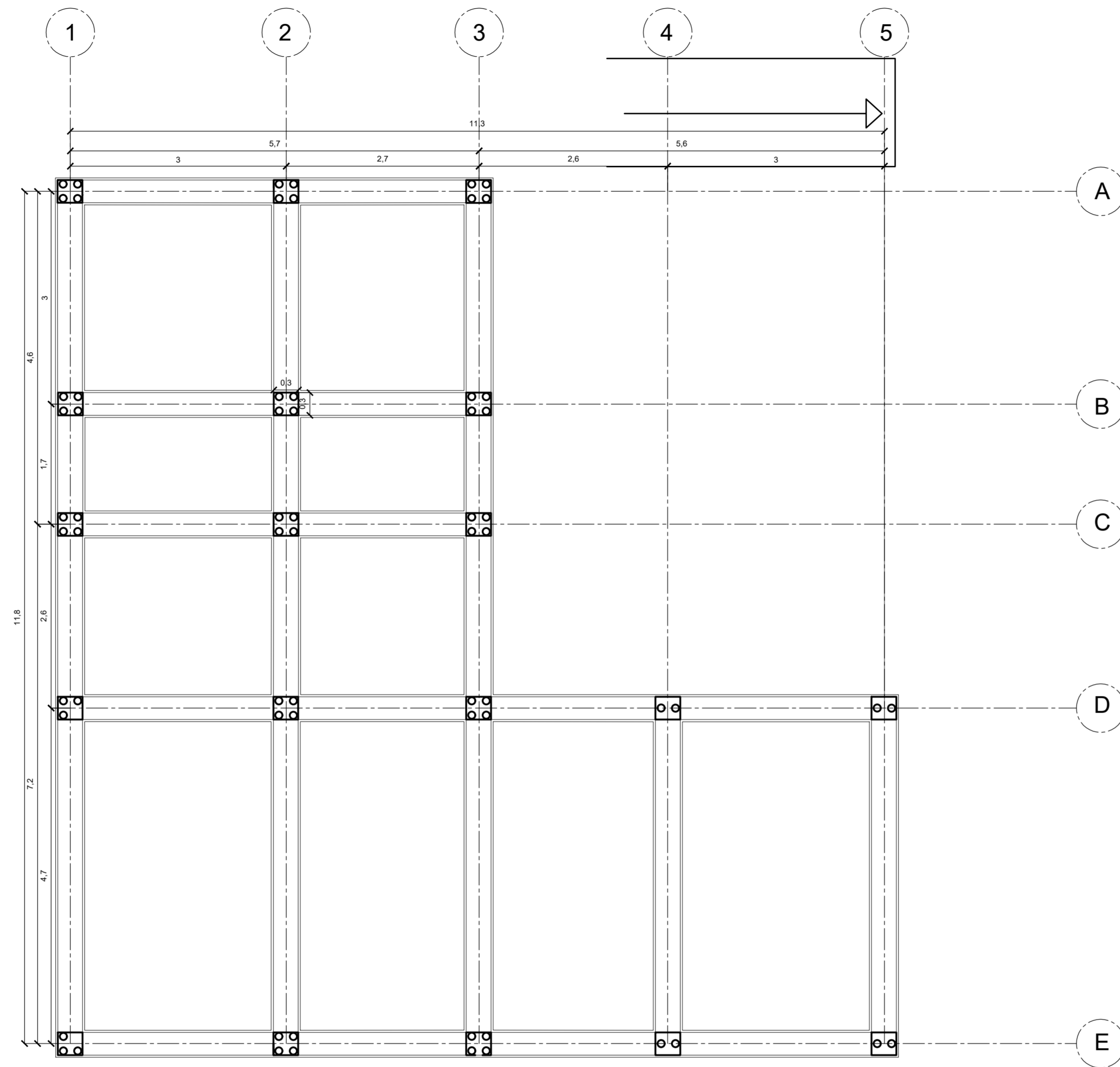

**A** PLANTA CIMENTACIÓN  
ESC:1:50

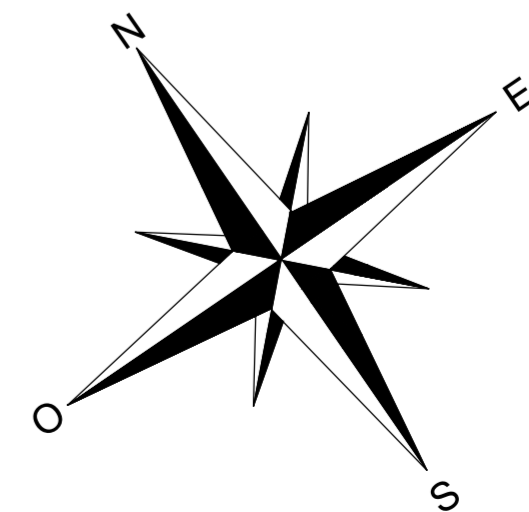

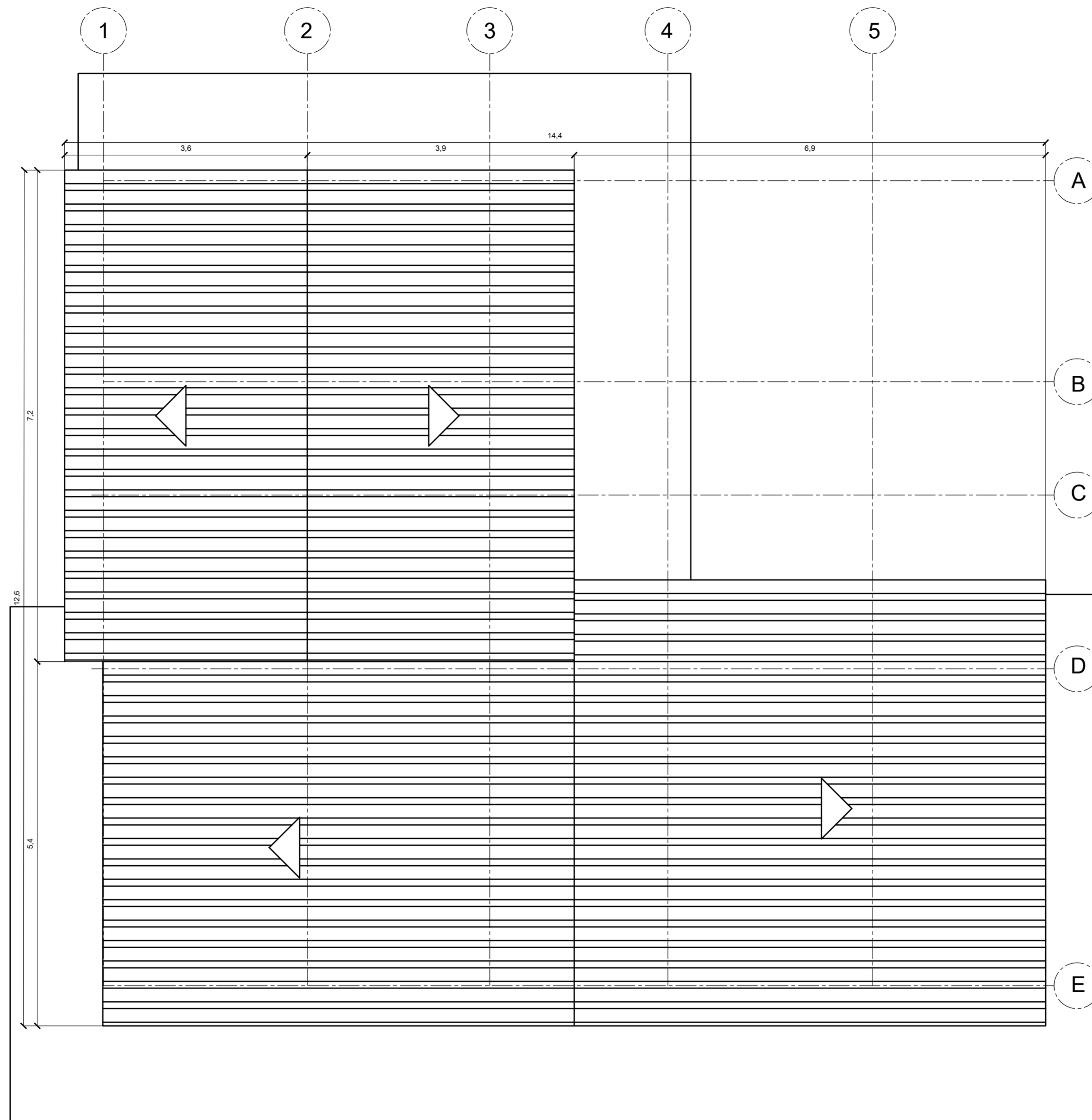

A PLANTA CUBIERTA  
ESC:1:50

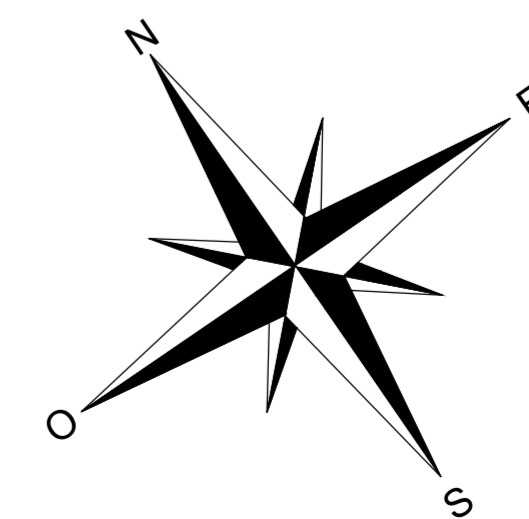

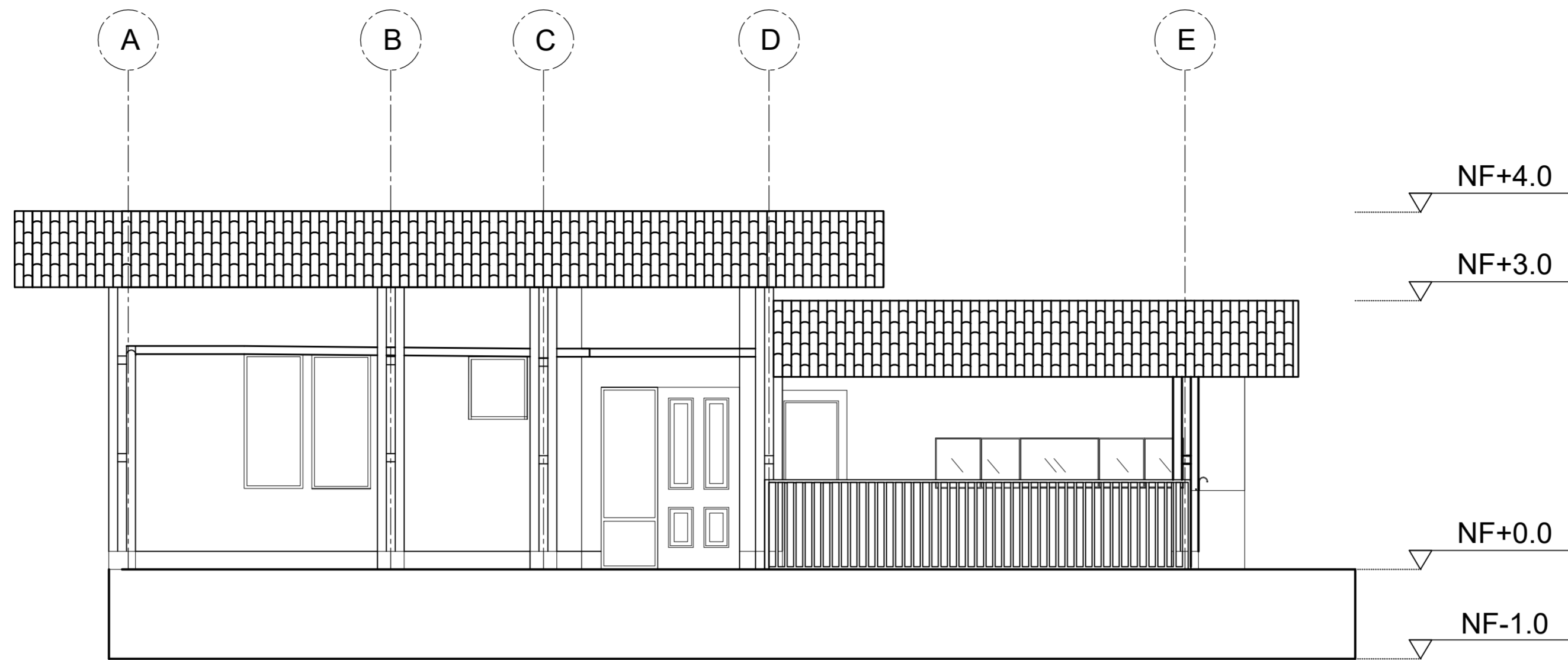

F FACHADA PRINCIPAL  
ESC:1:50

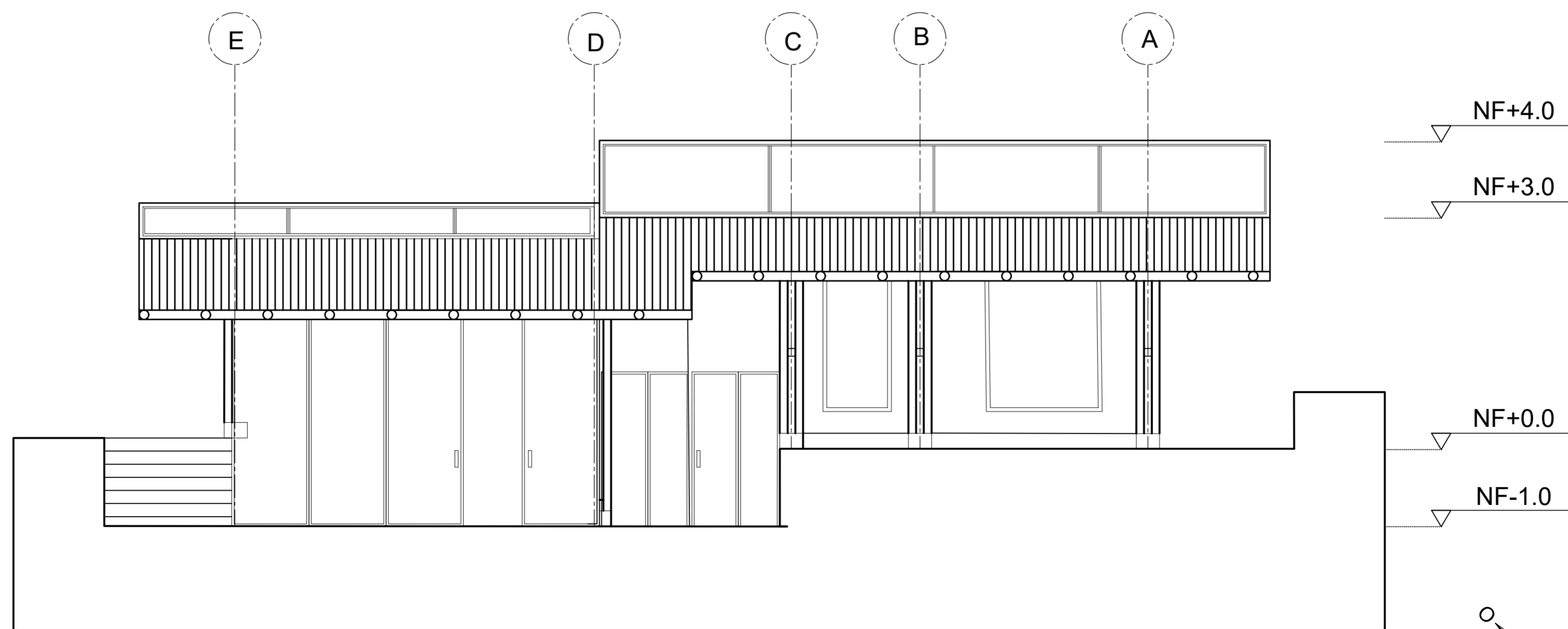
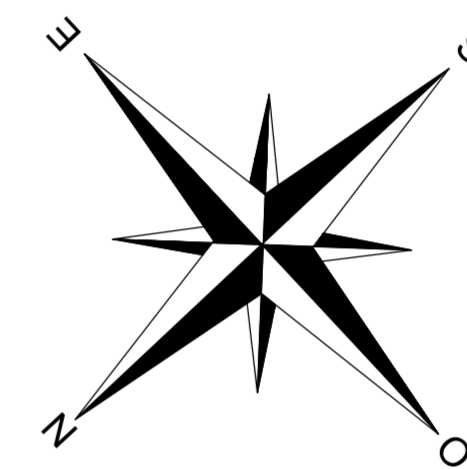

F FACHADA POSTERIOR  
ESC:1:50

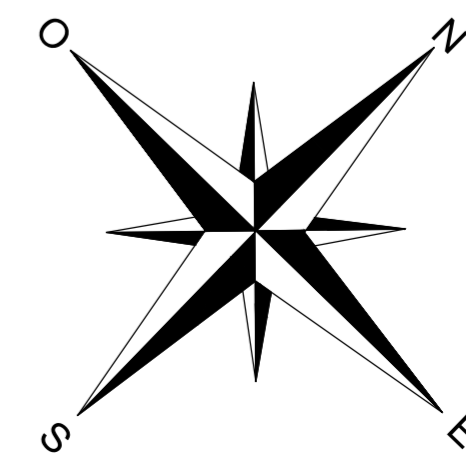

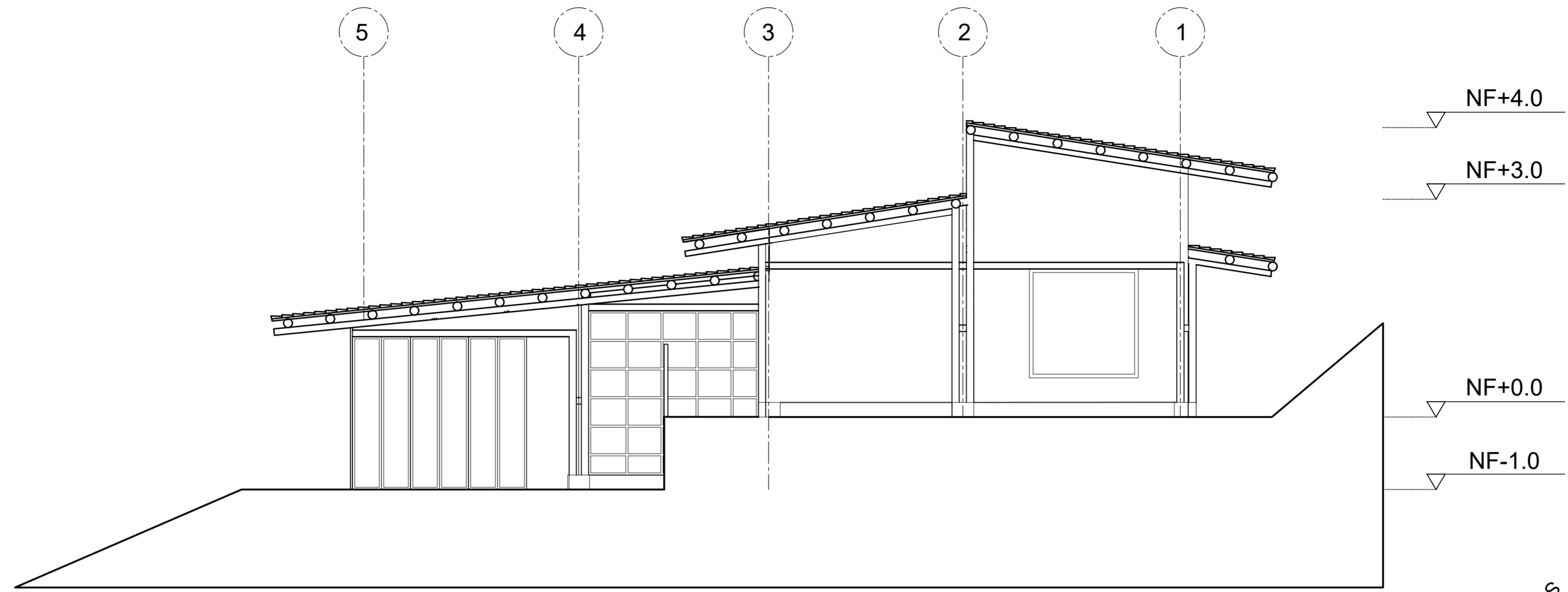

A FACHADA LATERAL DERECHA  
ESC:1:50

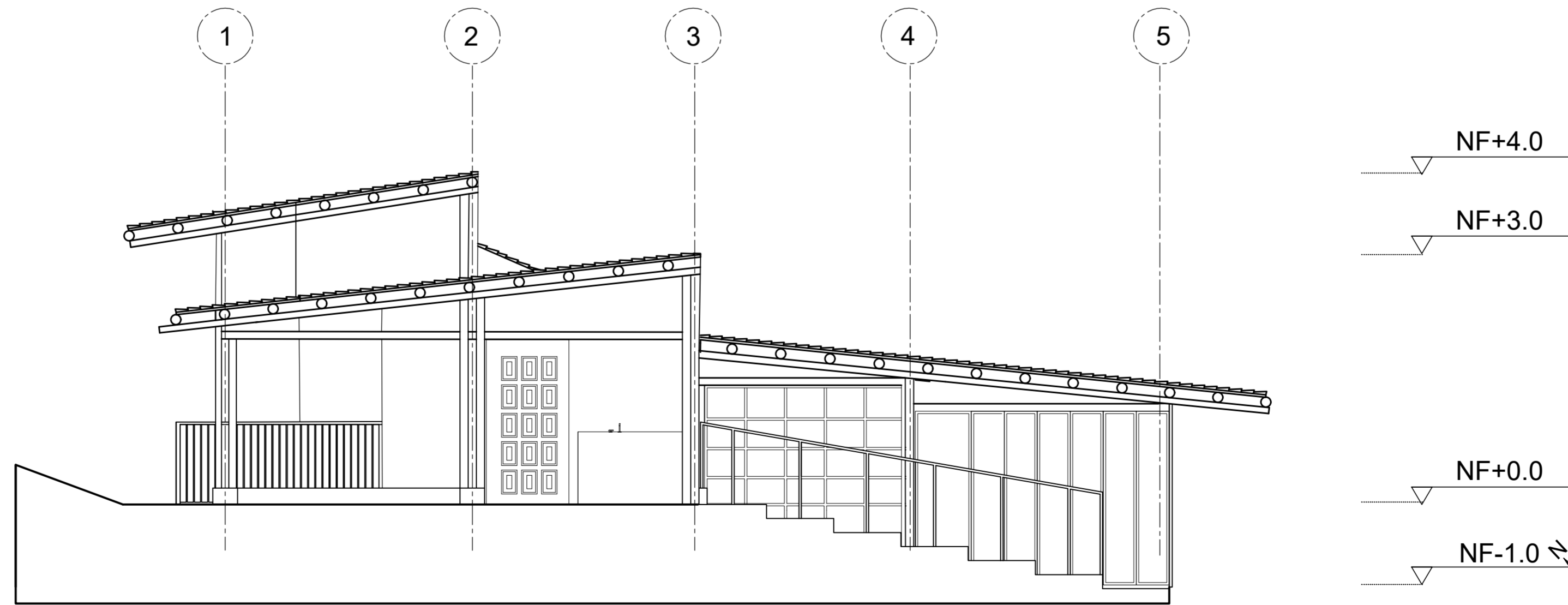
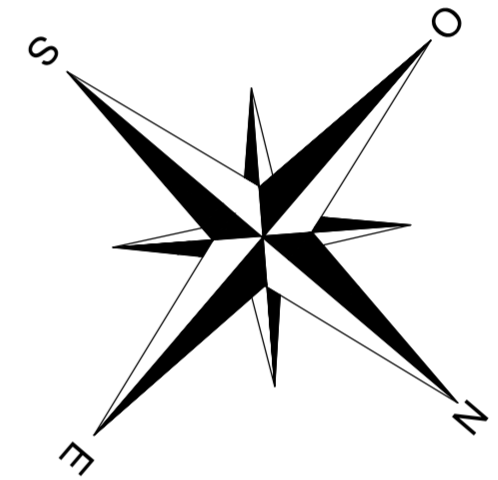

A FACHADA LATERAL IZQUIERDA  
ESC:1:50

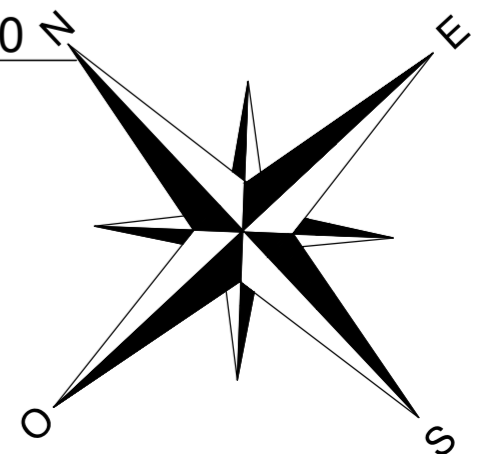

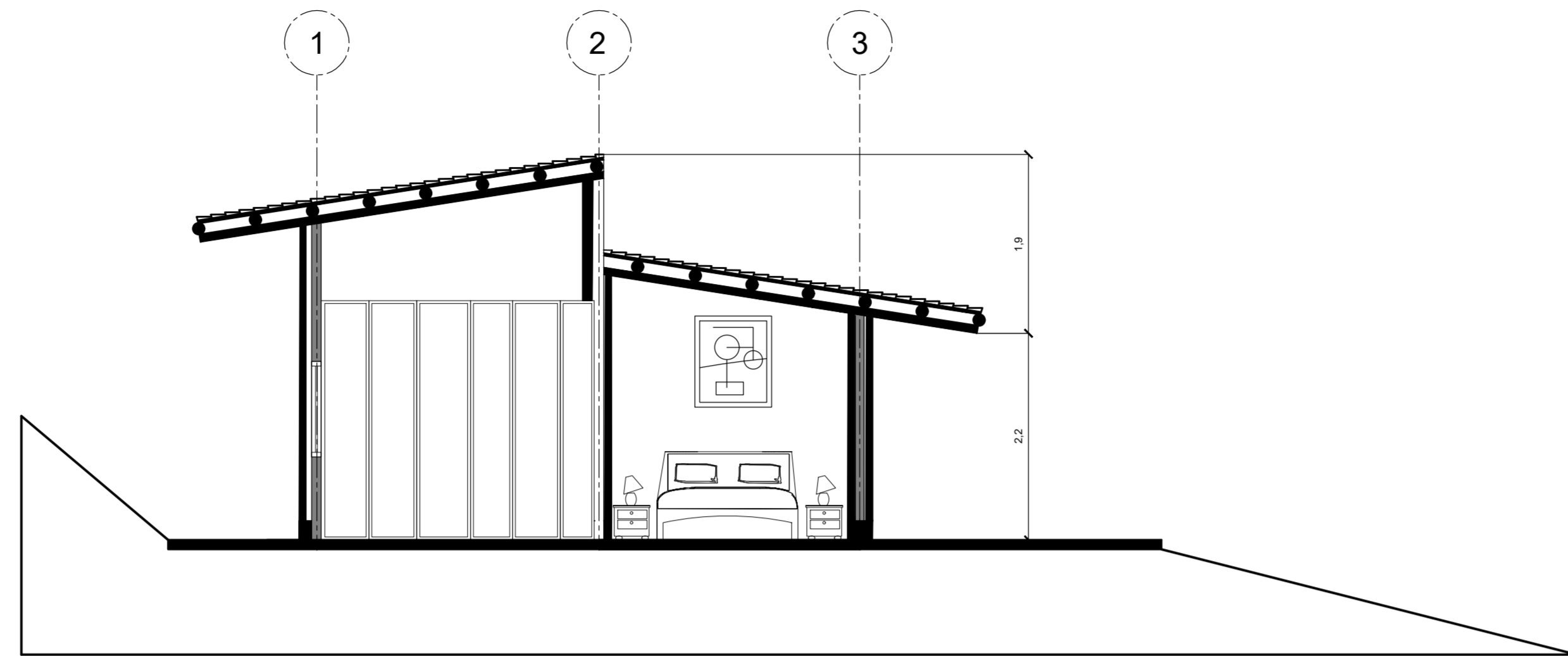

C CORTE A-A  
ESC:1:50

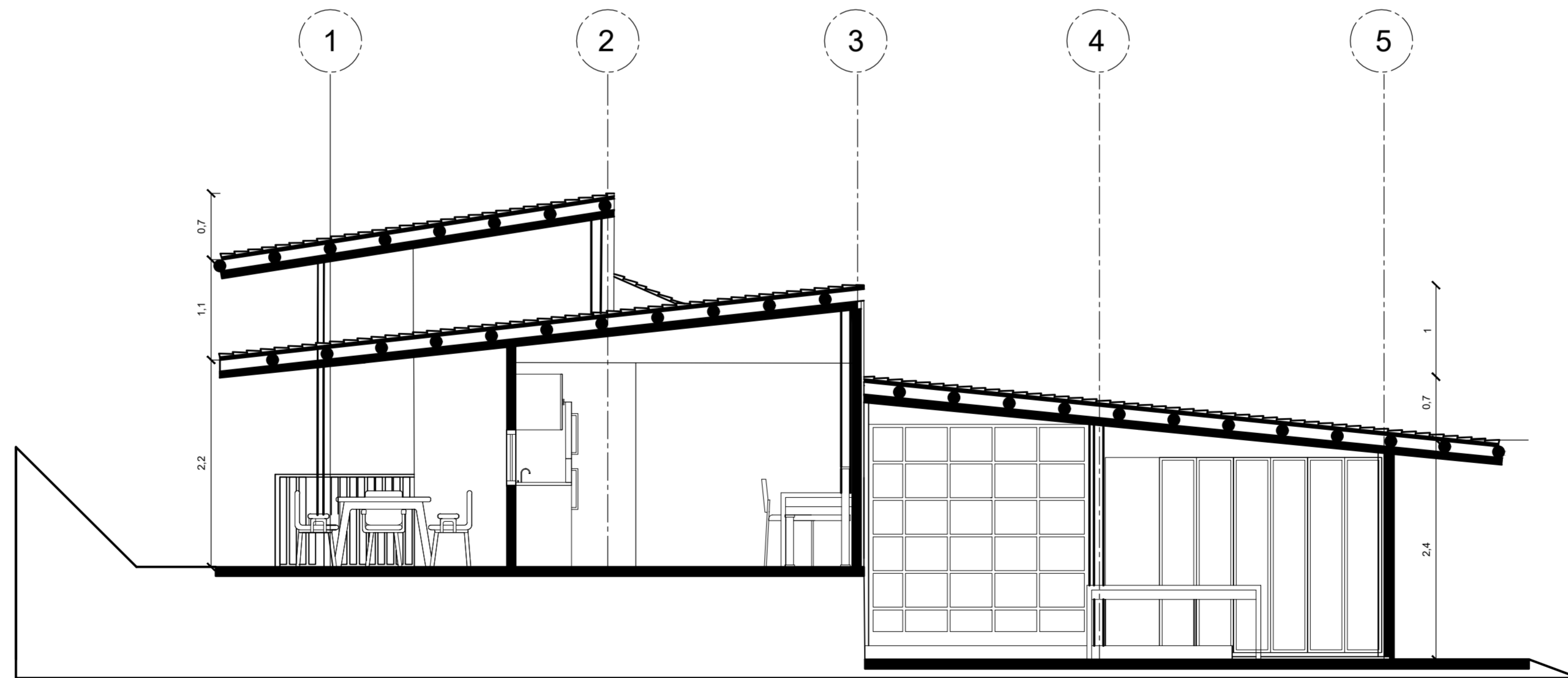
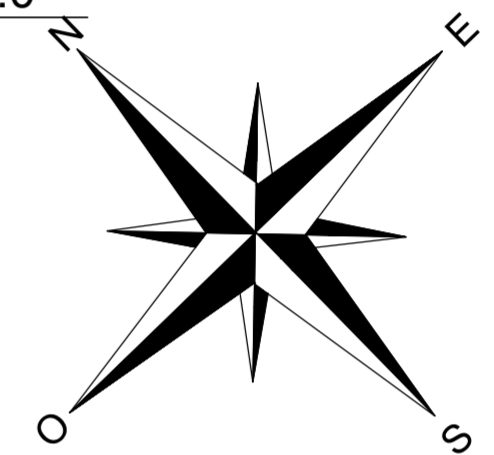
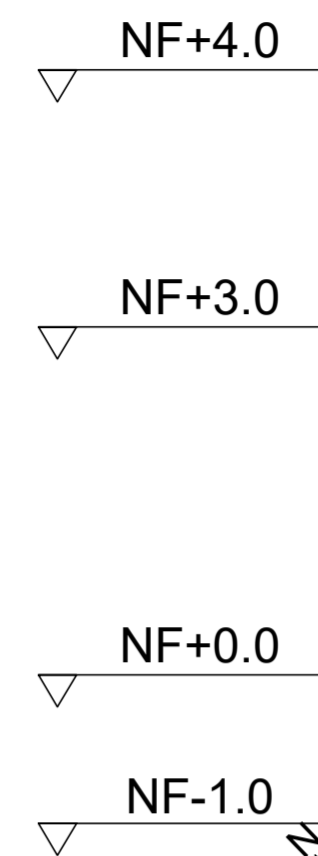

C CORTE A-A'  
ESC:1:50

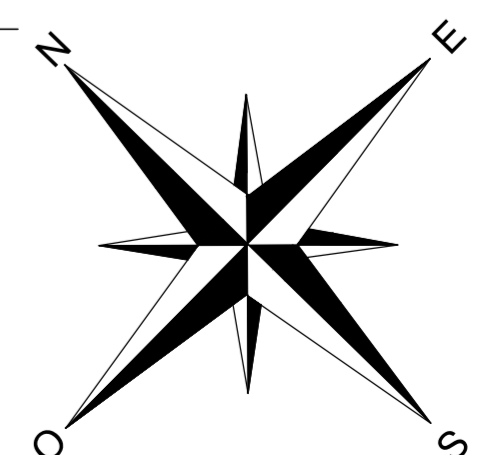

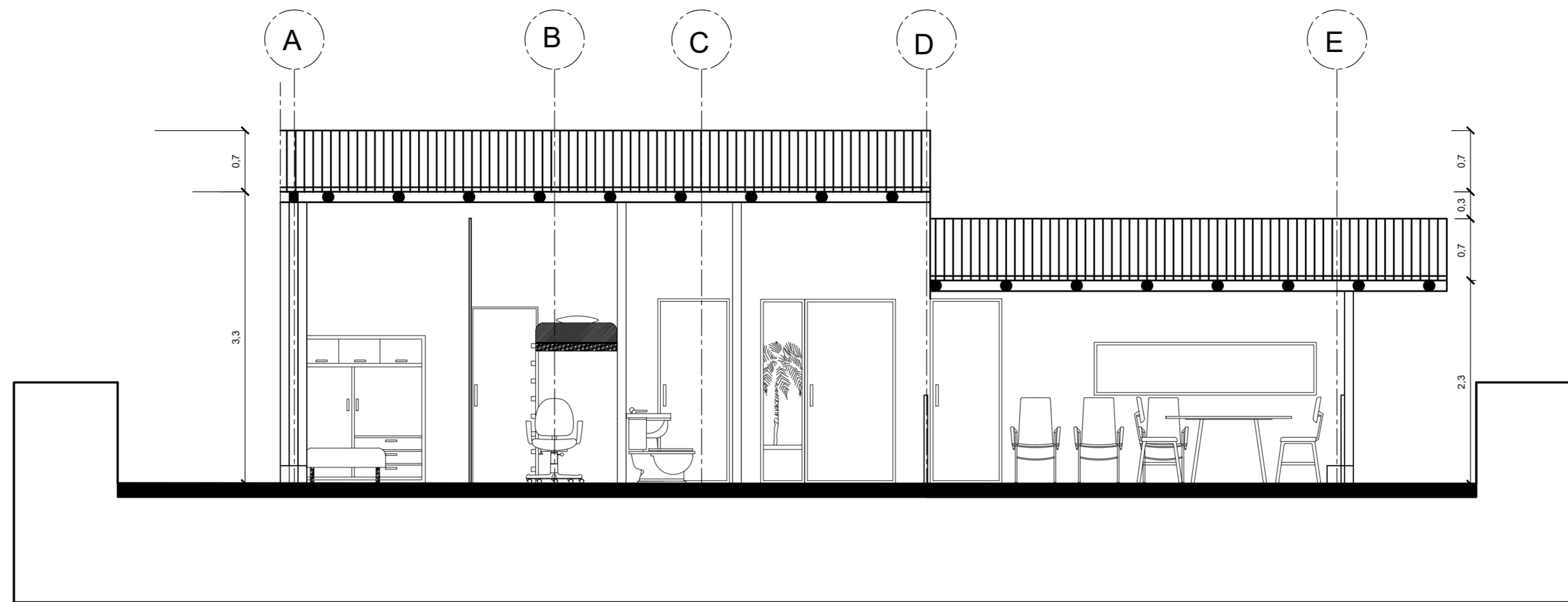

**C** CORTE B-B  
ESC:1:50

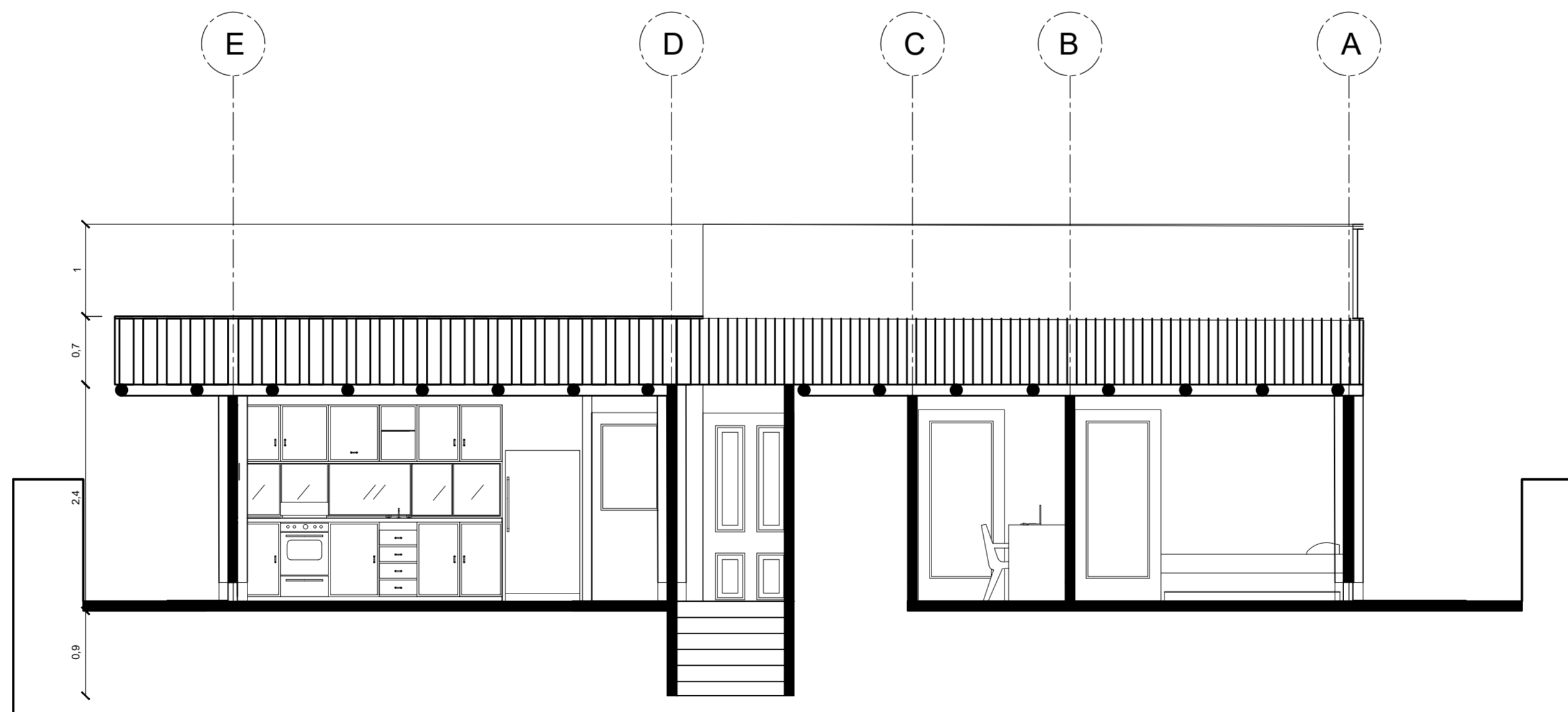
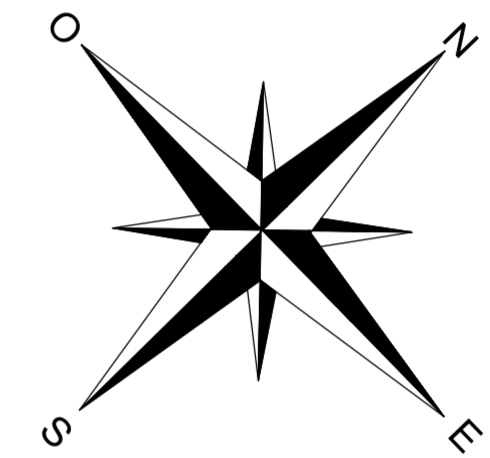
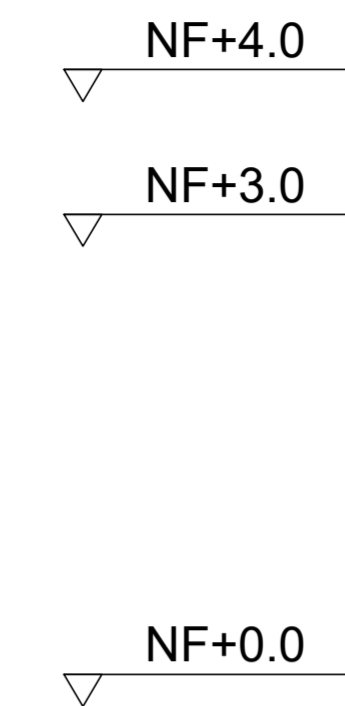

**C** CORTE B. B'  
ESC:1:50

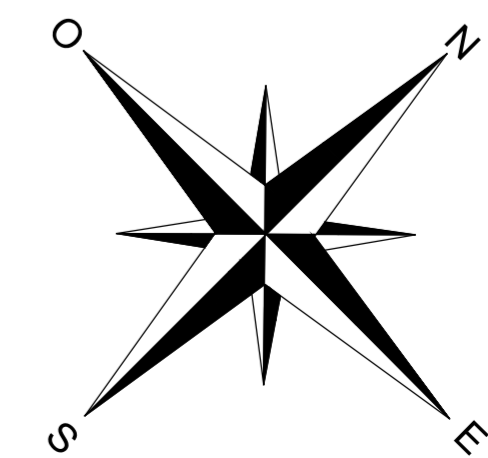
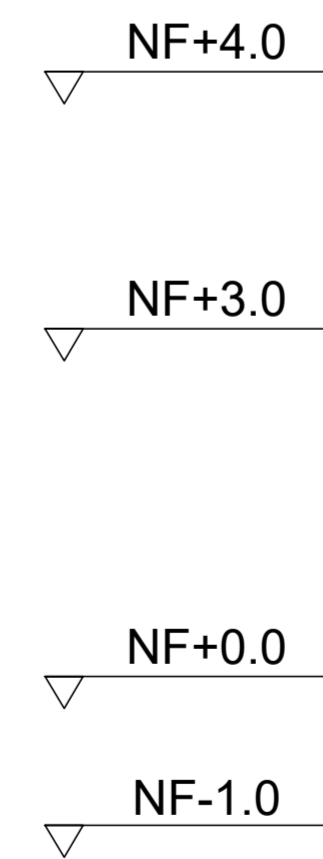

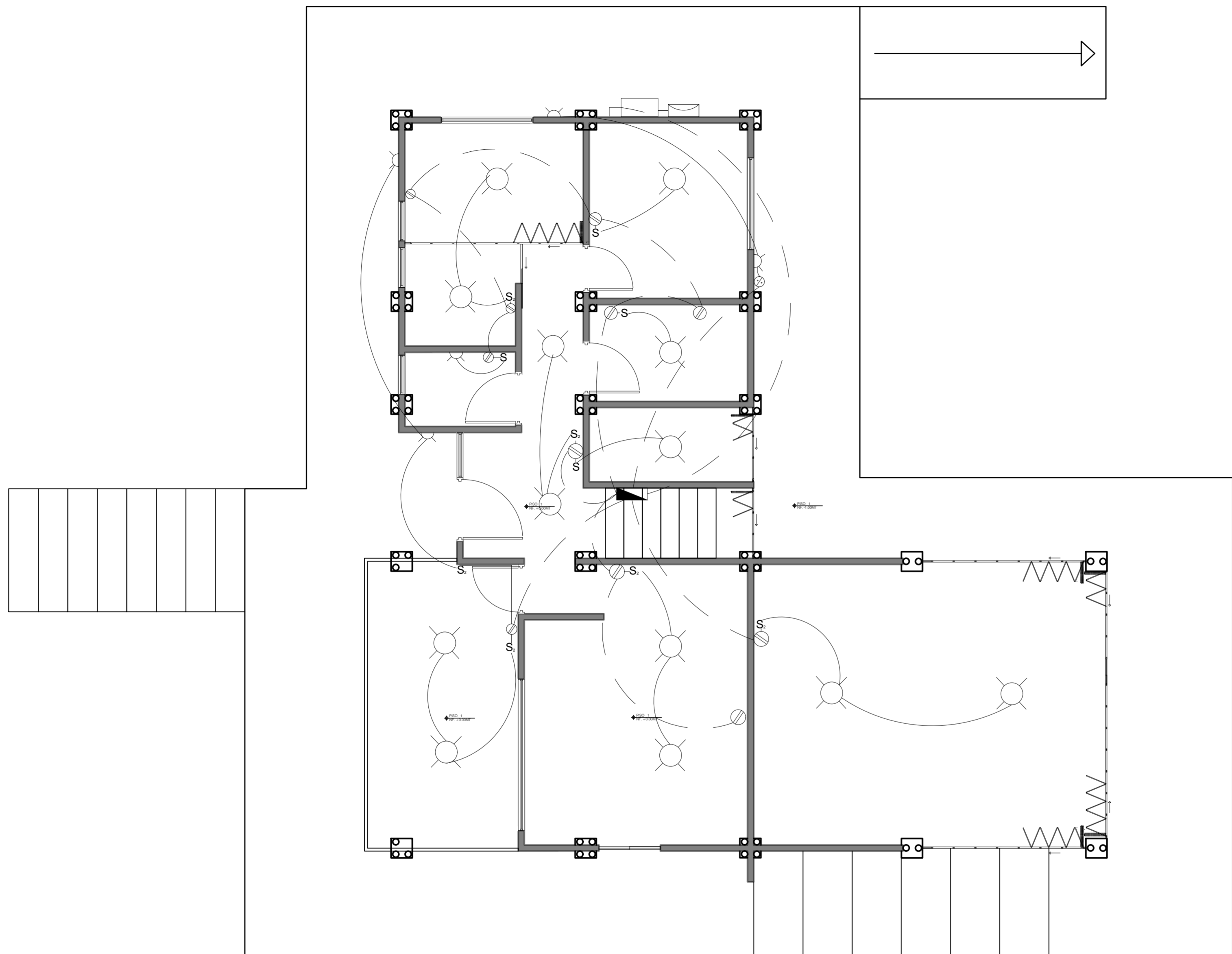

CONVENCION DE REDES, ACCESORIOS Y APARATOS ELECTRICOS	
	SWITCH GENERAL
	MEDIDOR DE LUZ
	TABLERO DE BRAKERS
	SALIDA ROSETA
	TOMA DOBLE
<b>S</b>	TOMA SENCILLA
<b>S<sub>2</sub></b>	TOMA DOBLE
- - -	TUBERIA BAJA
—	TUBERIA ALTA
—	TUBERIA TOMA A INTERRUPTOR

**L** INSTALACIONES ELECTRICAS  
ESC:1:50

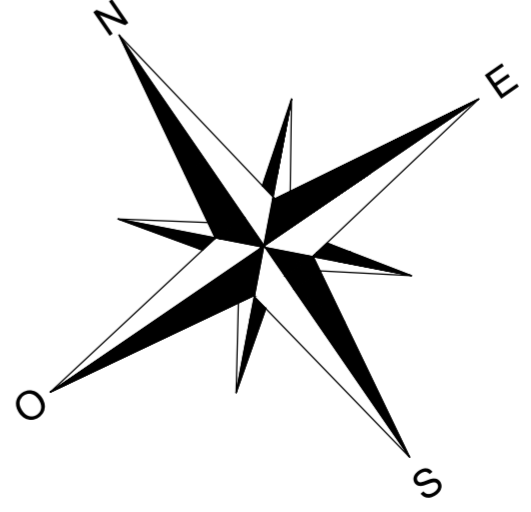

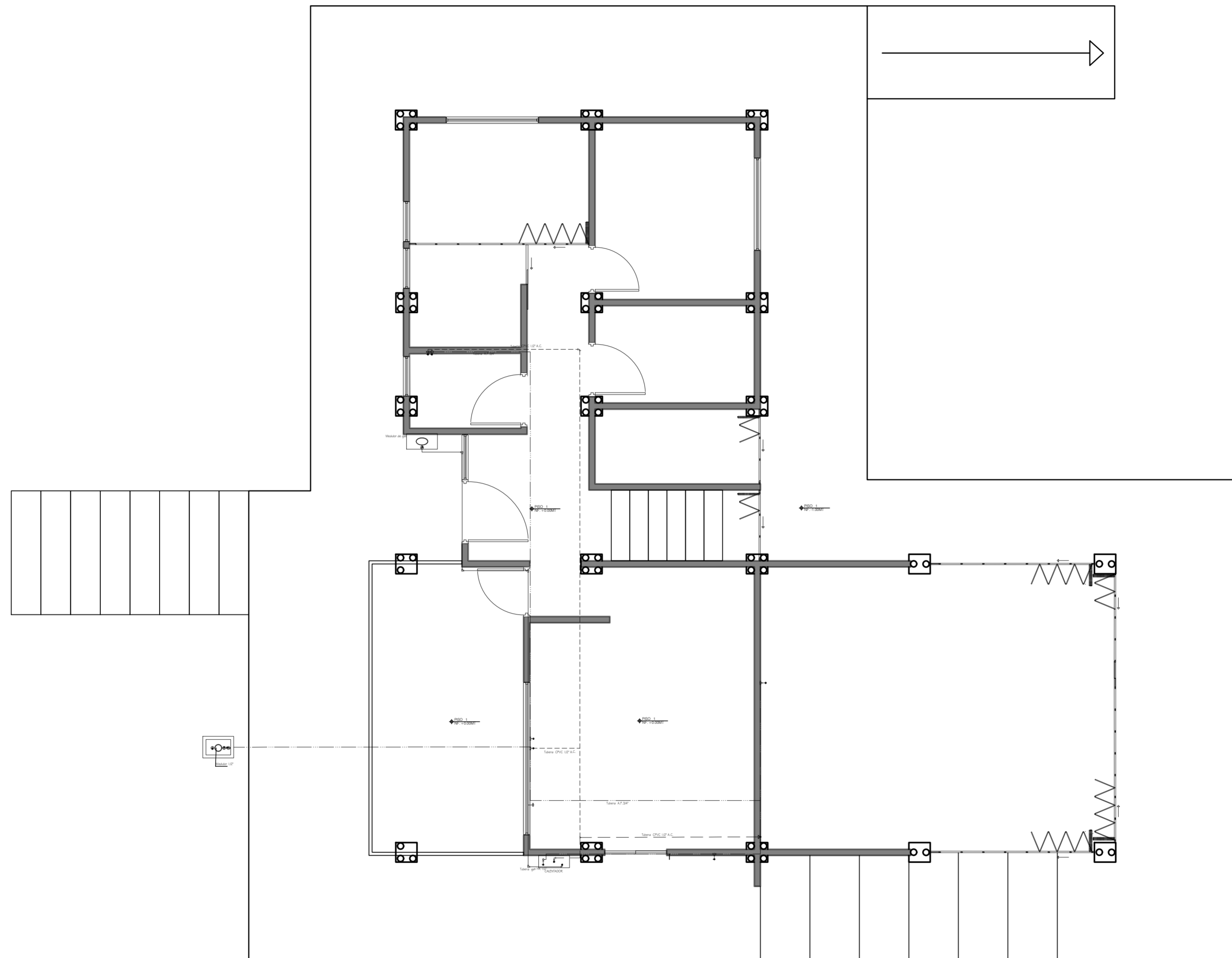

CONVENCION DE REDES, ACCESORIOS Y APARATOS HIDRAULICOS Y DE GAS	
	LLAVES SUMINISTRO
	MEDIDOR
	VALBULA DE BOLA
	TUBERIA AGUA CALIENTE
	TUBERIA AGUA FRIA
	TUBERIA DE GAS
	CODO 90° COBRE PARA GAS
	CODO 90°
	CALENTADOR DE AGUA
	MEDIDOR DE GAS
	PUNTO DE GAS

**H** INSTALACIONES HIDRAULICAS  
ESC:1:50

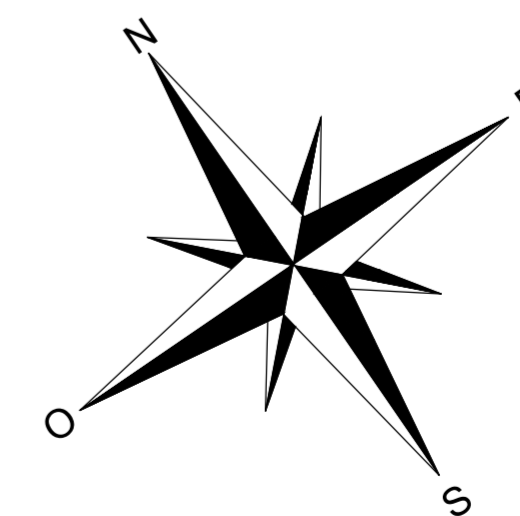

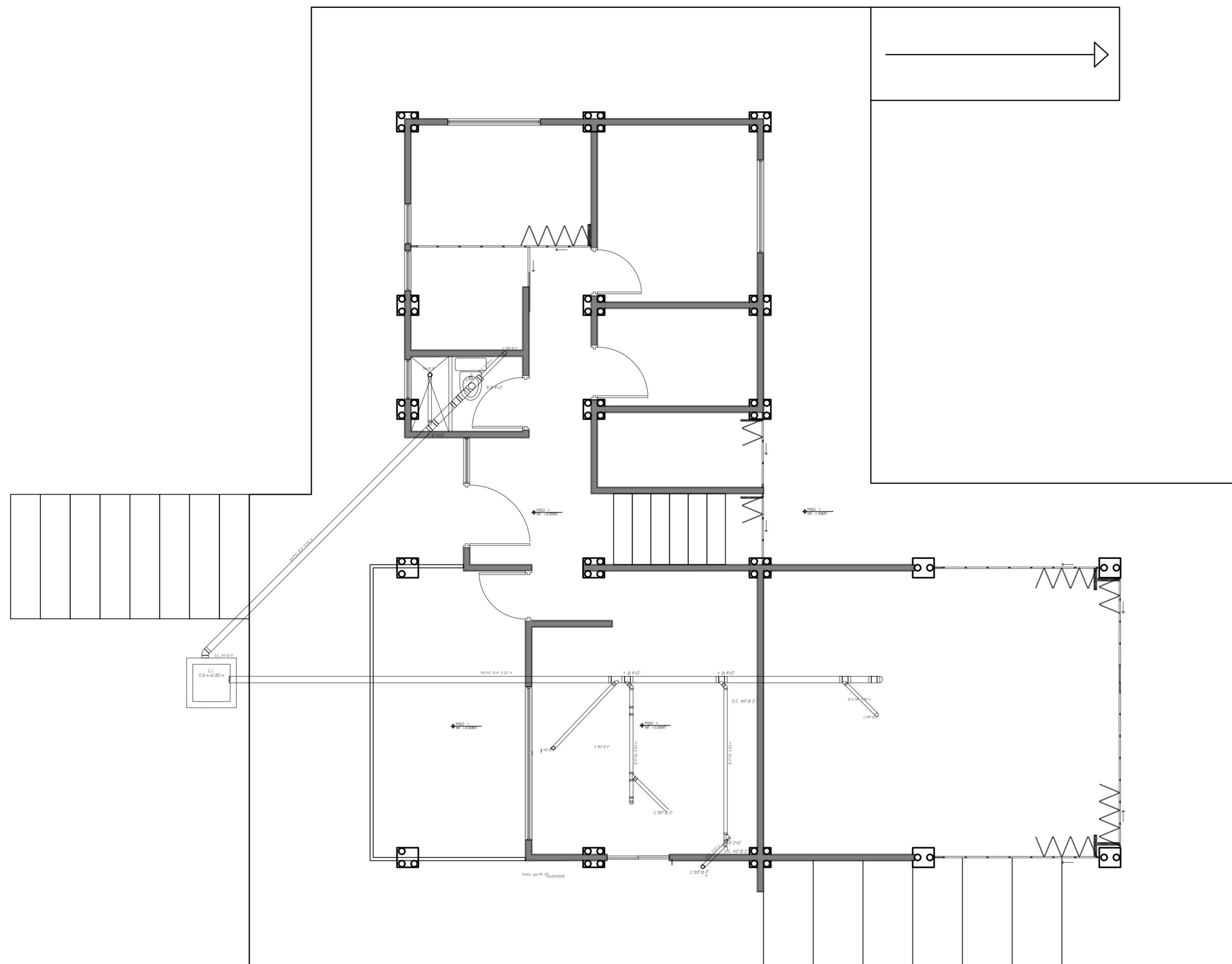

CONVENCION DE REDES, ACCESORIOS Y APARATOS SANITARIOS	
	CAJA DE INSPECCION
	CODO DE 45°
	YEE
	TEE

**Y** INSTALACIONES SANIRARIAS  
 ESC:1:50

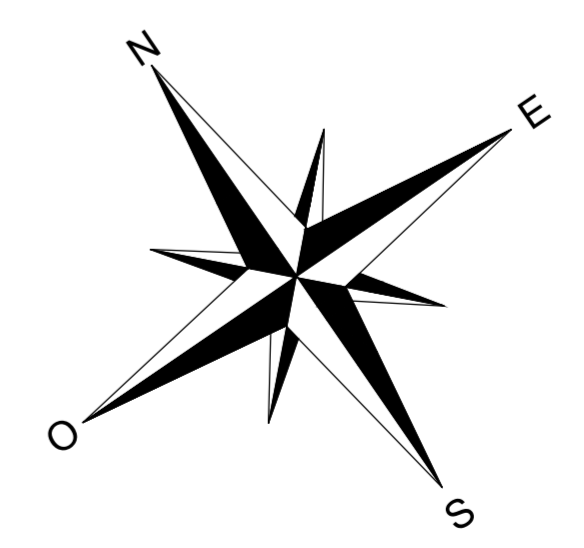

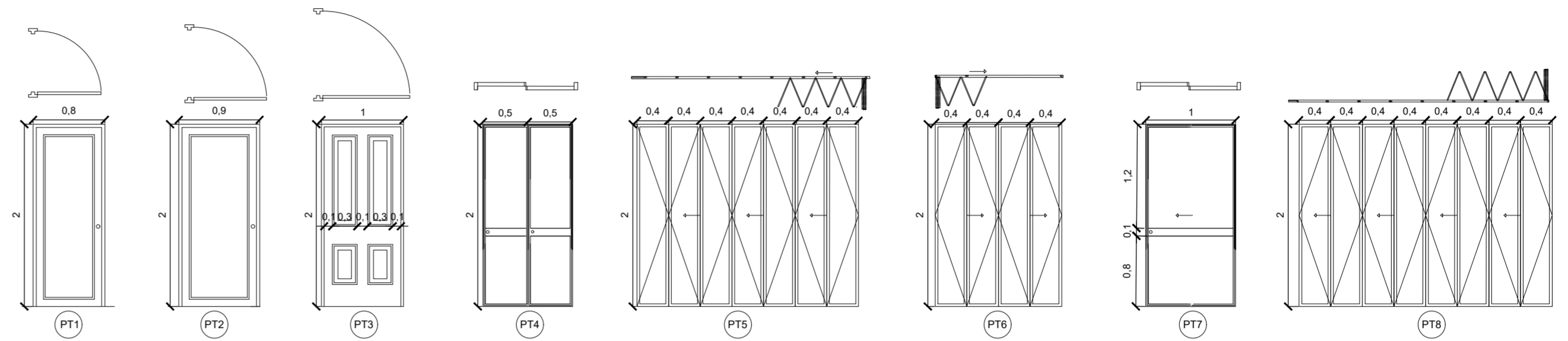
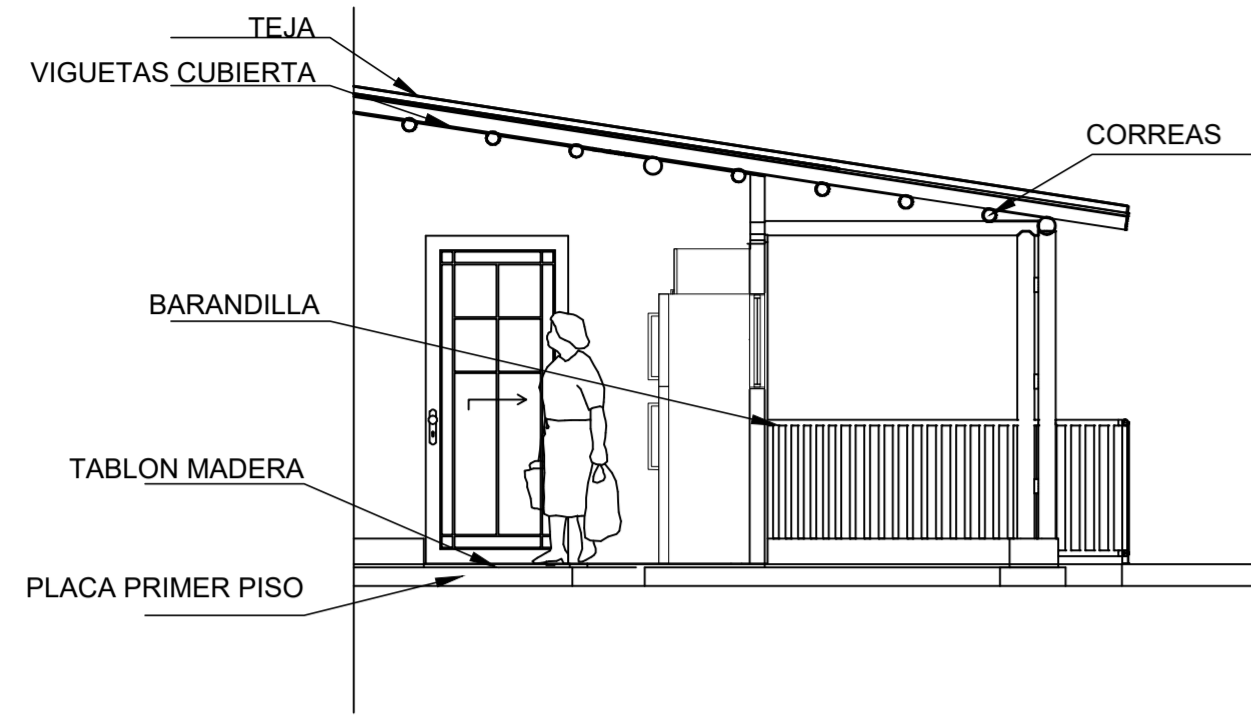

DT CORTE FACHADA  
ESC:1:50

CUADRO DE PUERTAS									
	TIPO DE PUERTAS	DIM. ANCHO	DIM. ALTO	CANTIDAD	DERECHA	IZQUIERDA	MARCO	CERRADURA	LOCALIZACIÓN
PUERTA 1	Madera batiente	0.8 m	2 m	2		1	MDF	Bronce	Habitacion, porche
PUERTA 2	Madera batiente	0.9 m	2 m	2	1	1	Cedro	Bronce	Estudio, Baño
PUERTA 3	Madera batiente	1 m	2 m	1	1		Cedro	Bronce	Acceso
PUERTA 4	Madera corredera	1 m	2 m	1		1	MDF	madera	Terraza
PUERTA 5	Madera plegable	2.8 m	2 m	3	2	1	Madera	Bronce	Produccion
PUERTA 6	Madera plegable	1.6 m	2 m	1		1	Madera	Bronce	Produccion
PUERTA 7	Madera corredera	1 m	2 m	1		1	Madera	Bronce	Espacio flexible
PUERTA 8	Madera plegable	3.2 m	2 m	1	1		Madera	Bronce	Habitacion Flexible

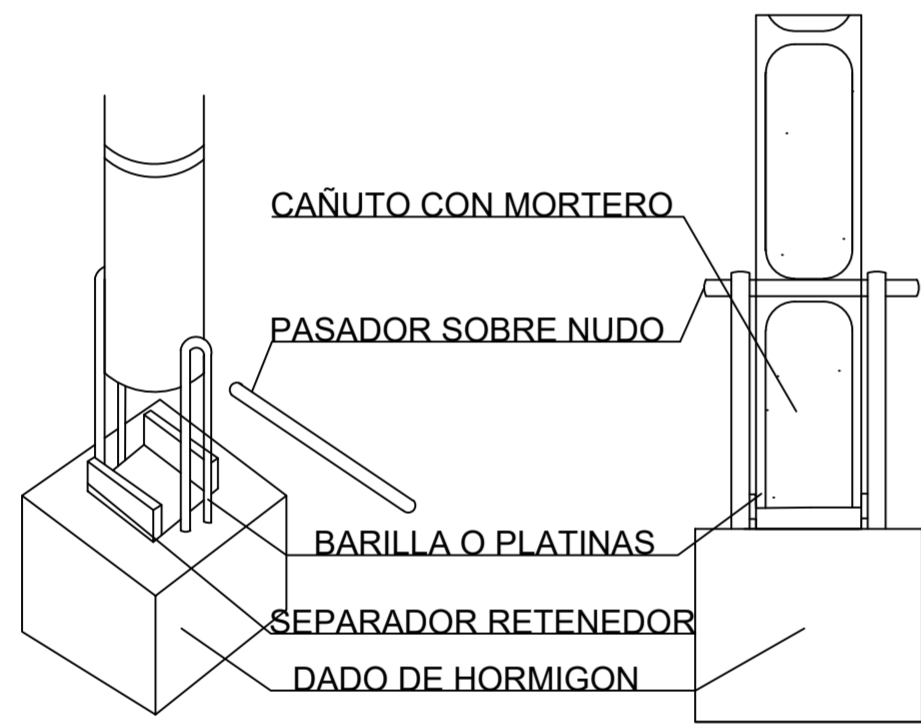

DT DETALLE BASE COLUMNA  
ESC:1:10

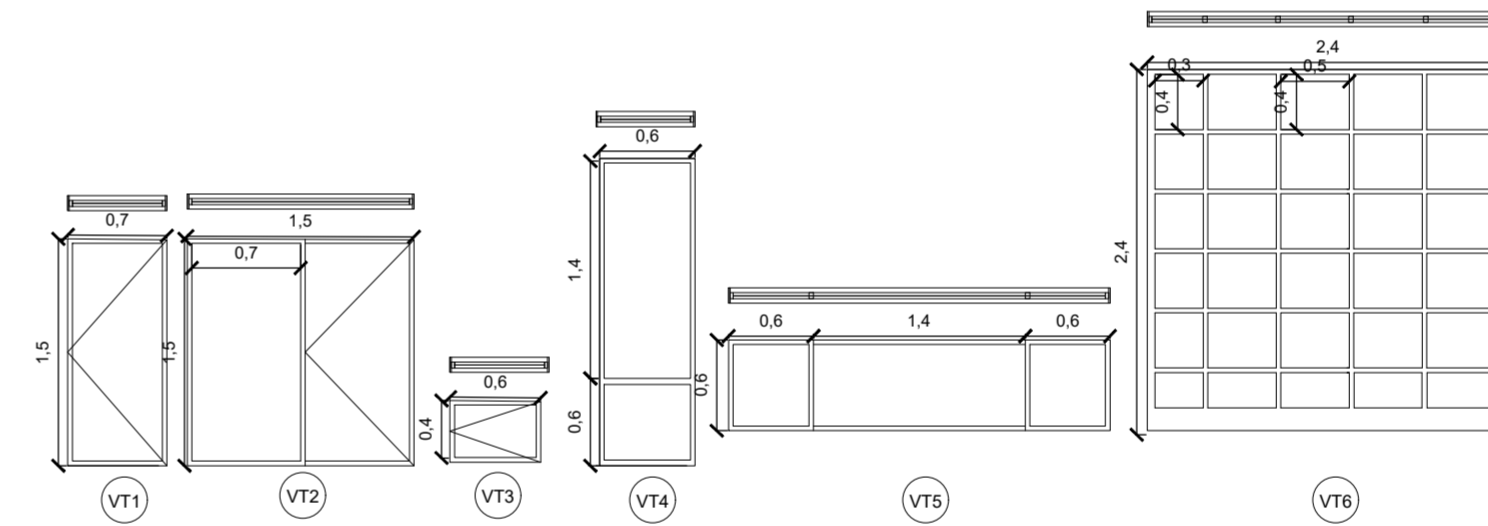

CUADRO DE VENTANAS											
	TIPO DE VENTANA	DIM. ANCHO	DIM. ALTO	BATIENTE DER.	BATIENTE IZQ.	BATIENTE SUP.	BATIENTE INF.	CANTIDAD	MARCO	CERRADURA	LOCALIZACIÓN
VENTANA 1	Batiente	0.7 m	1.5 m	1	1			2	aluminio	Aluminio	Hab. flexible
VENTANA 2	Corredera	1.5 m	1.5 m	2			1	2	aluminio	Aluminio	Habitaciones
VENTANA 3	Batiente	0.6 m	0.4 m			1		1	aluminio	Aluminio	Baño
VENTANA 4	Fija	0.6 m	2 m					1	aluminio	Aluminio	Acceso
VENTANA 5	Corredera	2.6 m	0.6 m					1	aluminio	Aluminio	Cocina
VENTANA 6	Fija	2.4 m	2.4 m					1	aluminio	Aluminio	Produccion

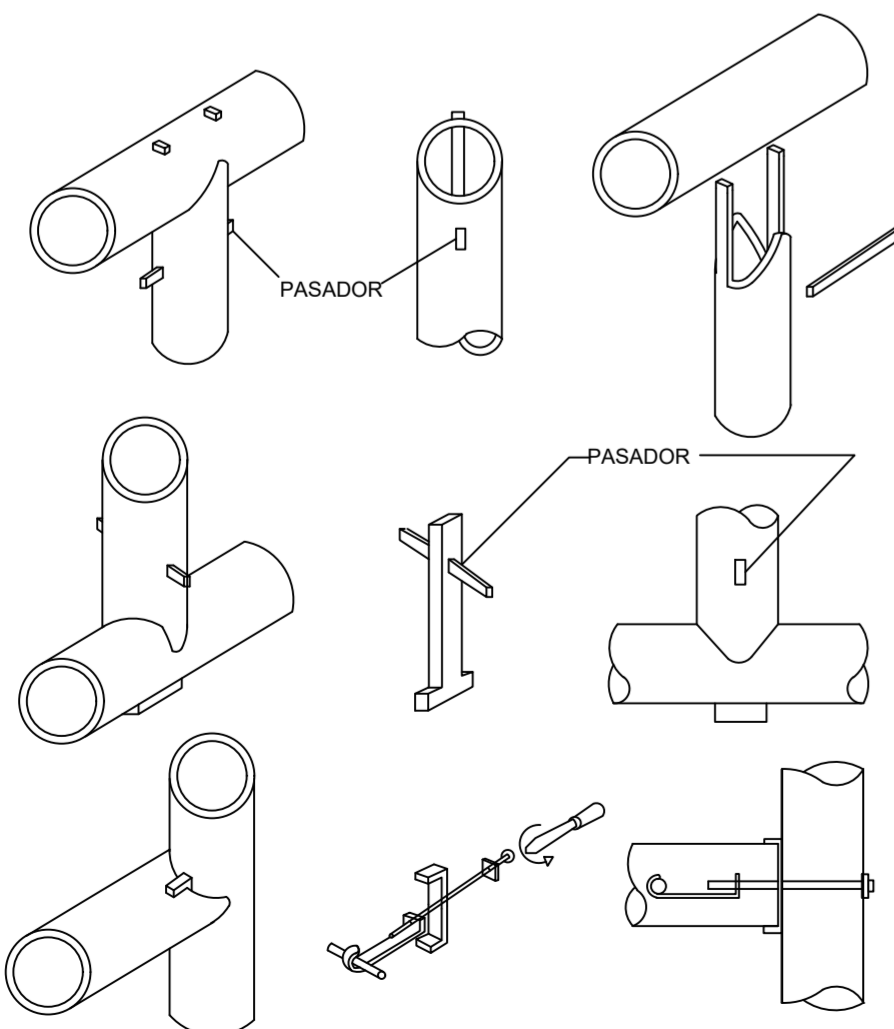

DT DETALLE UNIONES EN GUADUA  
ESC:1:10

# PROTOTIPO II

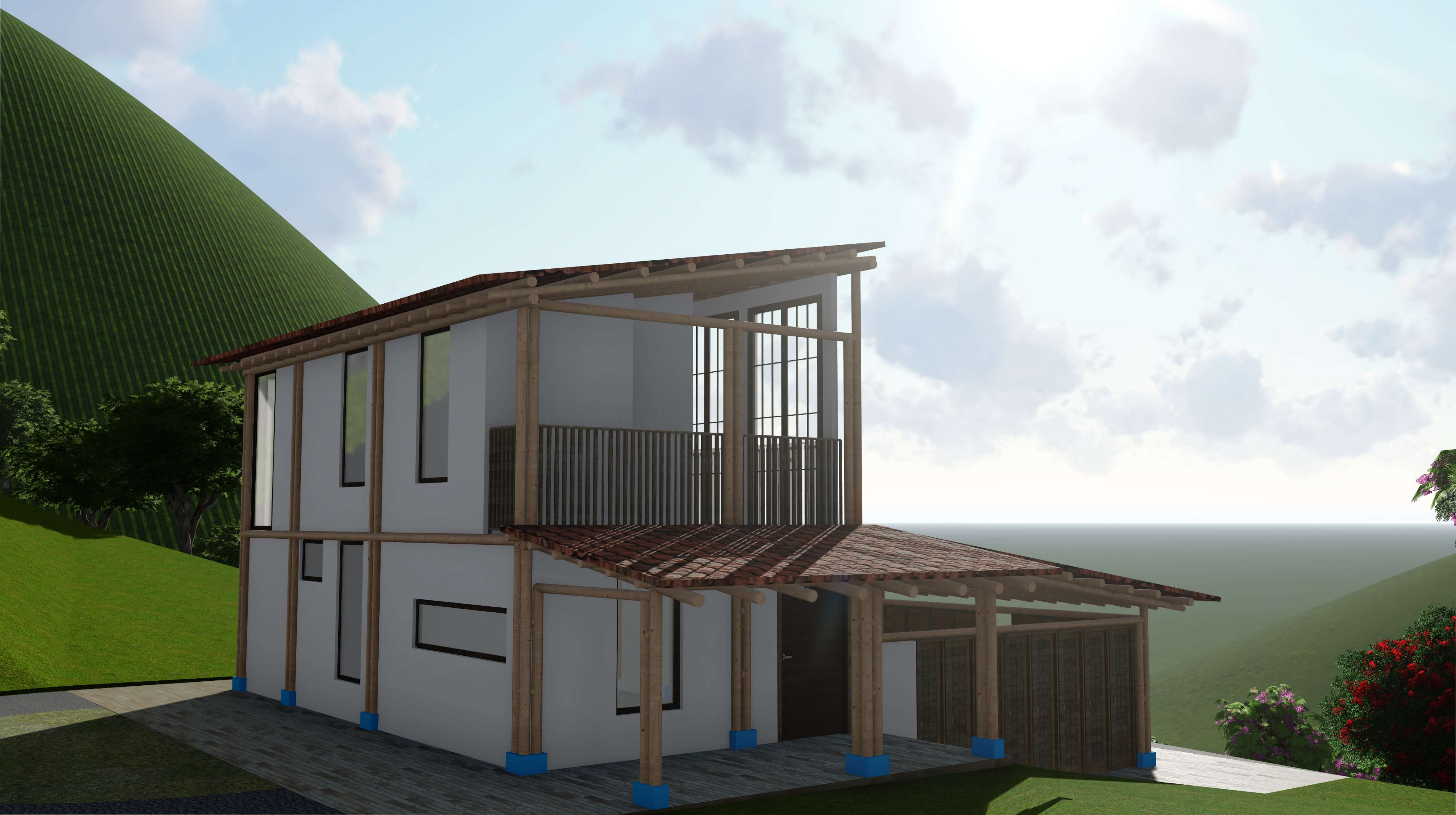

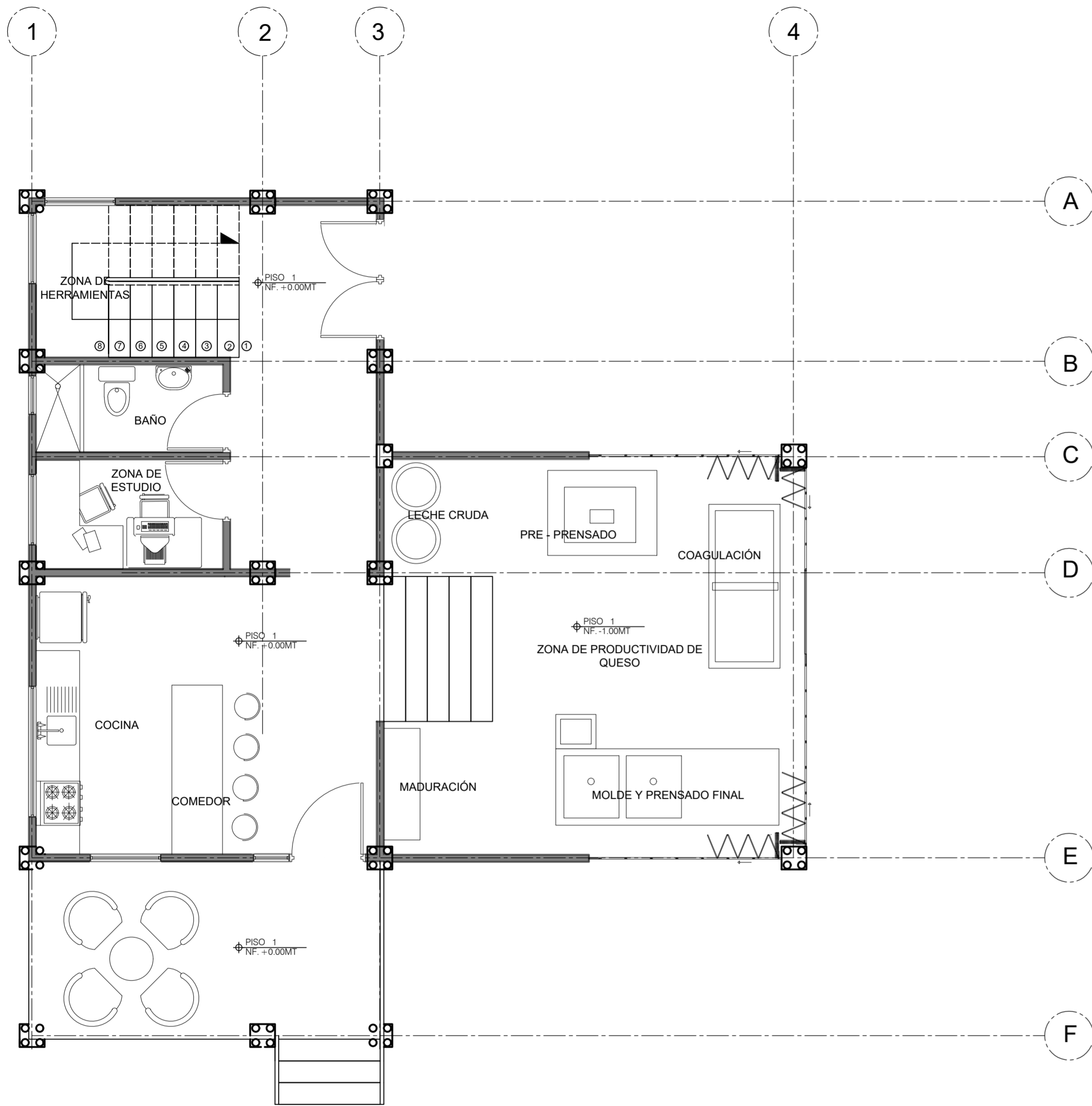

**A** PLANTA ARQUITECTÓNICA  
ESC:1:50

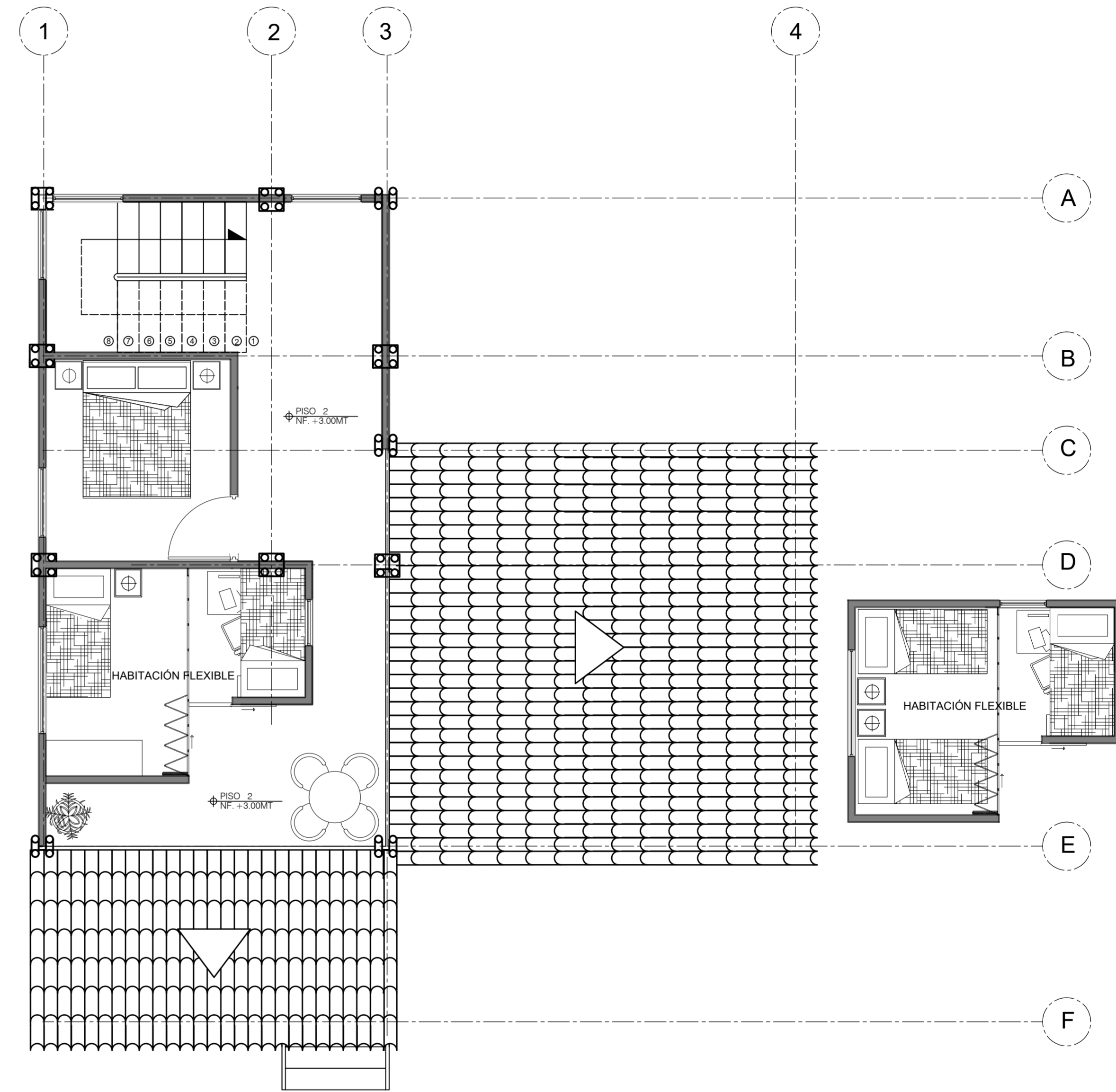

**A** PLANTA ARQUITECTÓNICA  
ESC:1:50

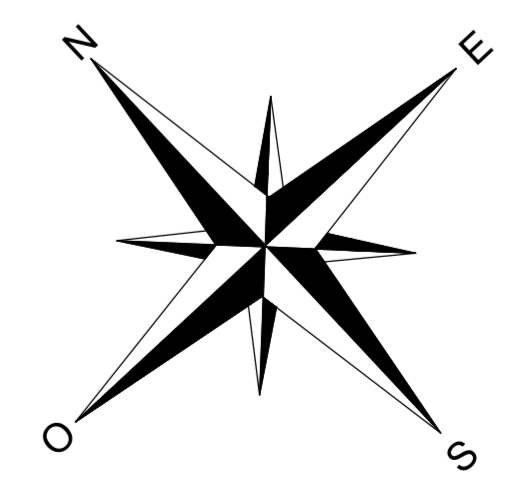

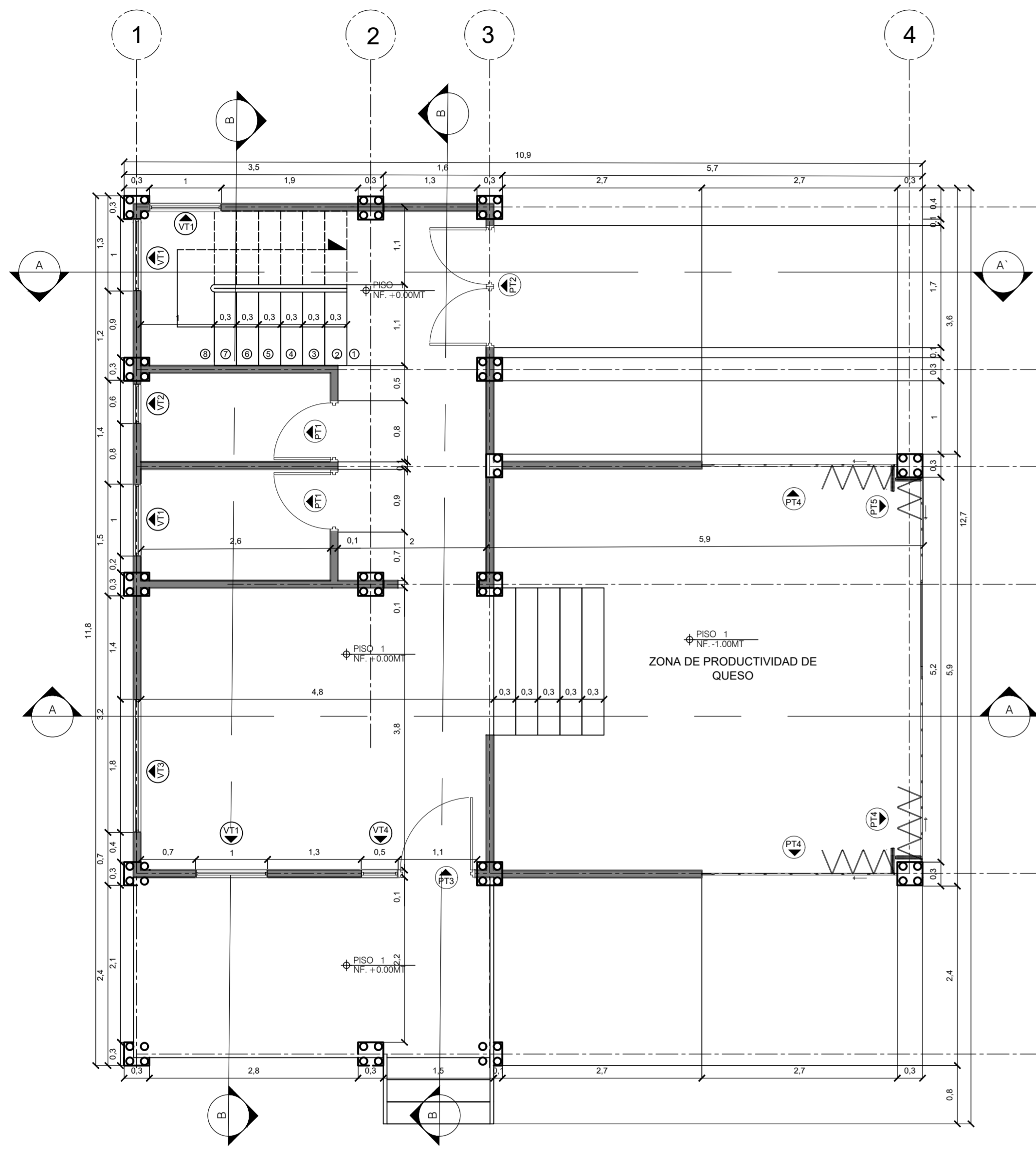

**A** PLANTA ARQUITECTÓNICA  
ESC:1:50

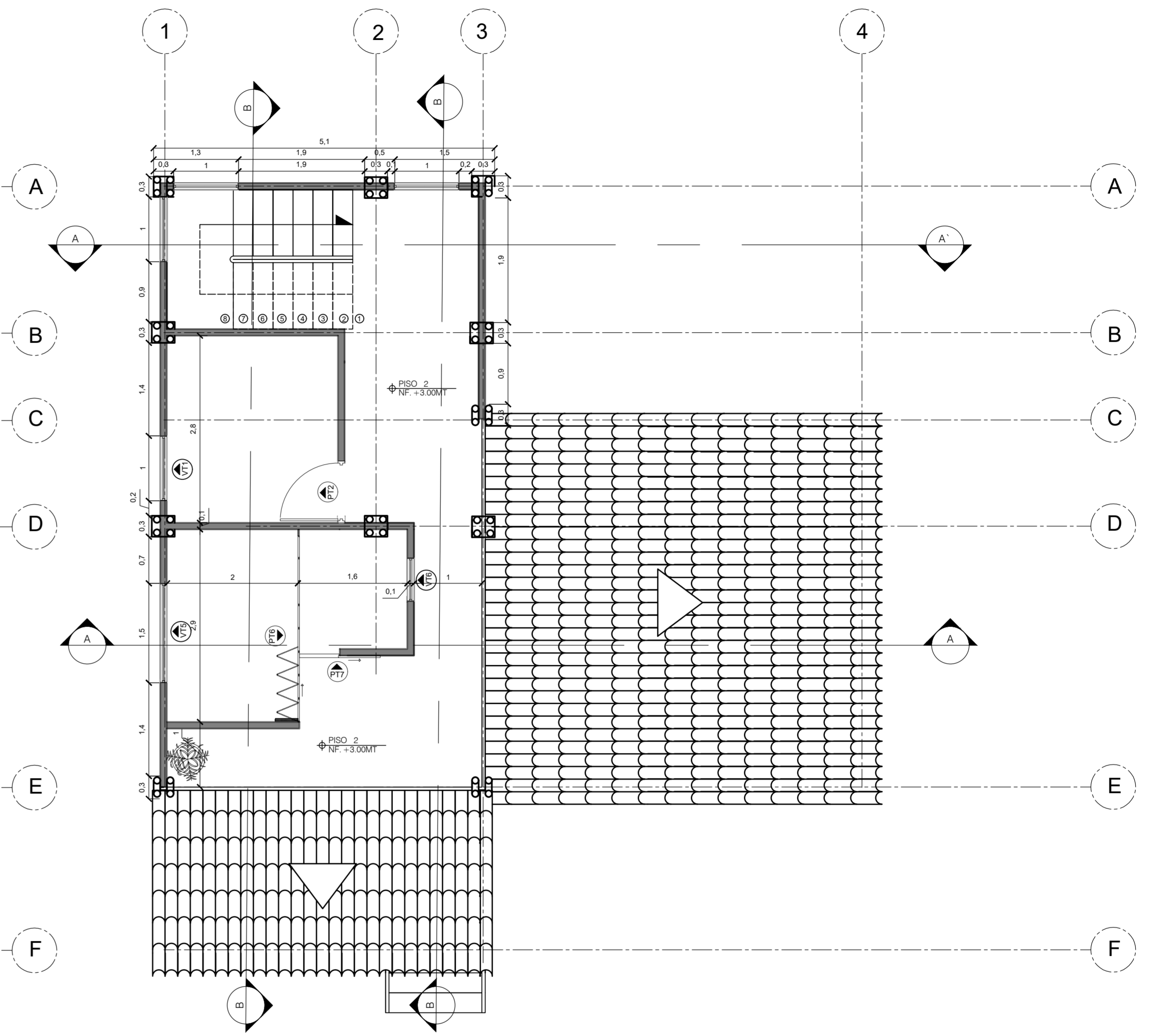

**A** PLANTA ARQUITECTÓNICA  
ESC:1:50

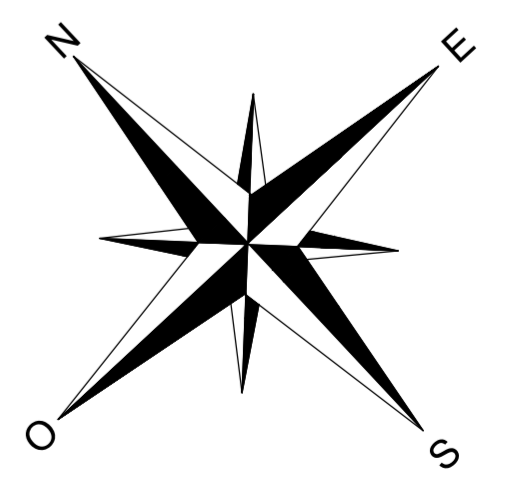

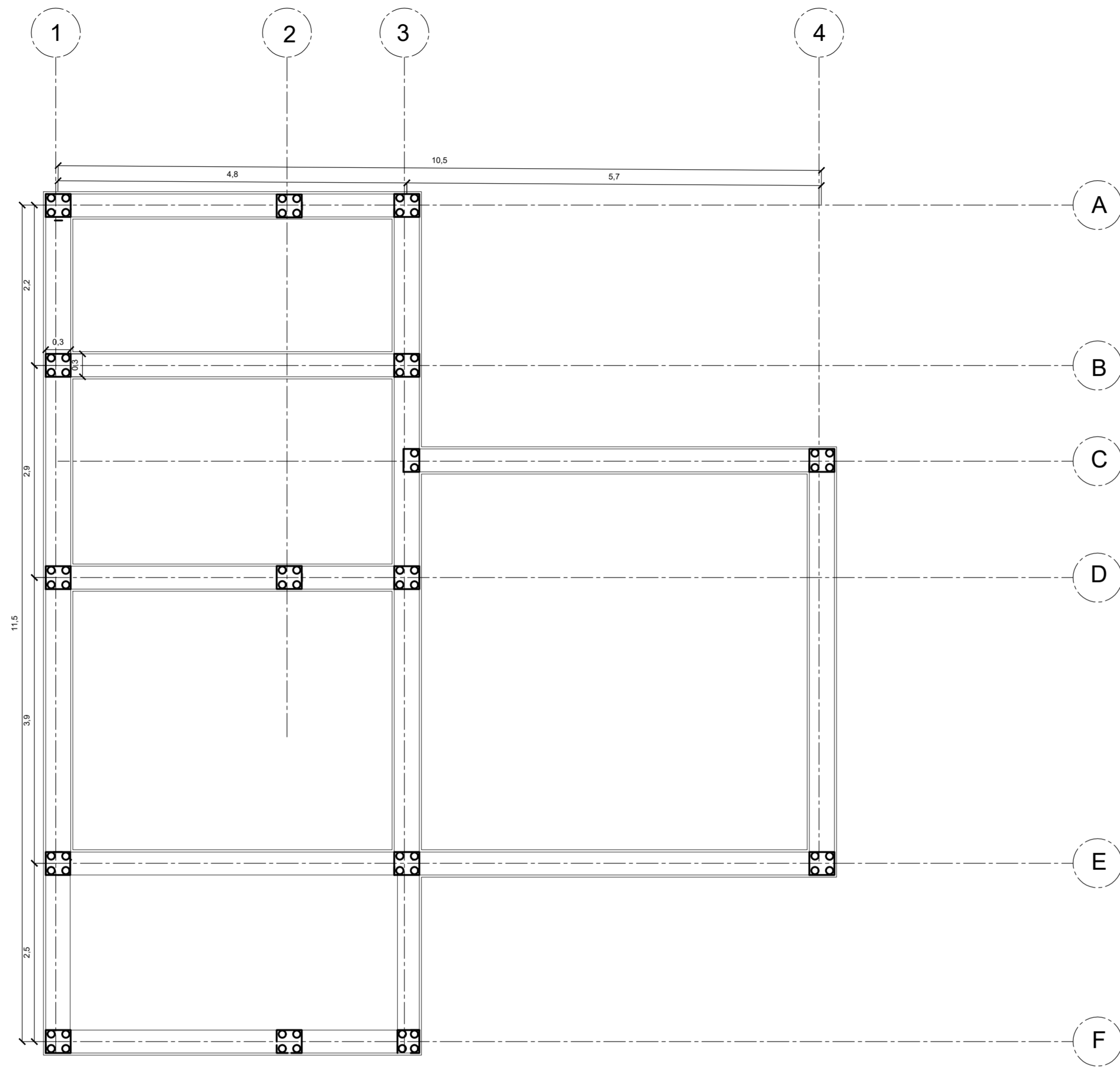

**A** PLANTA CIMIENTOS  
 ESC:1:50

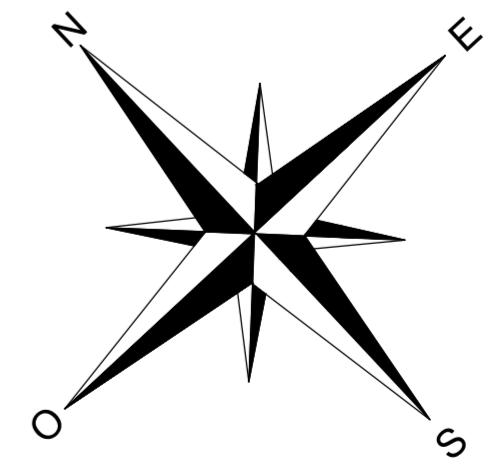

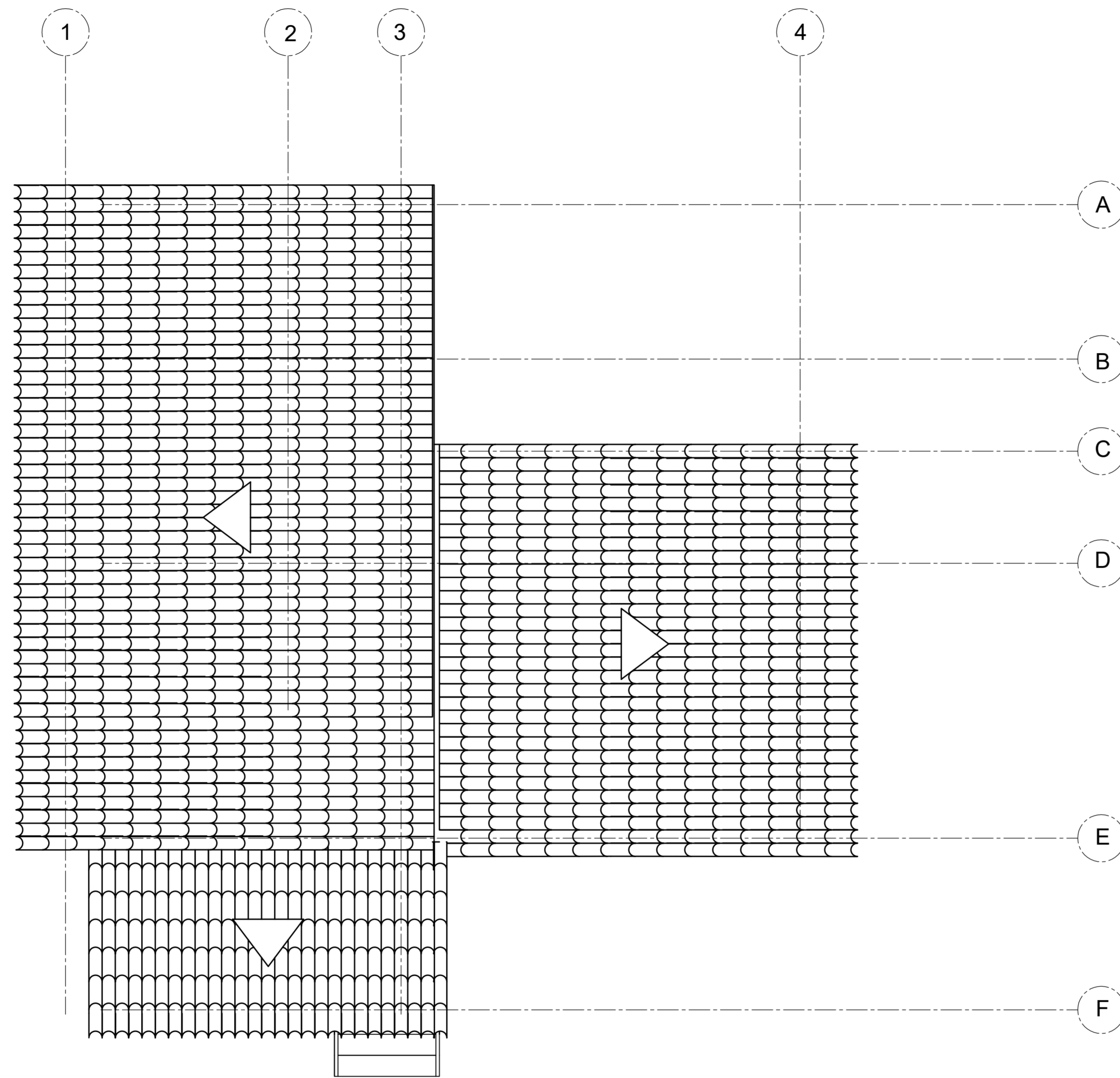

A PLANTA CUBIERTAS  
ESC:1:50

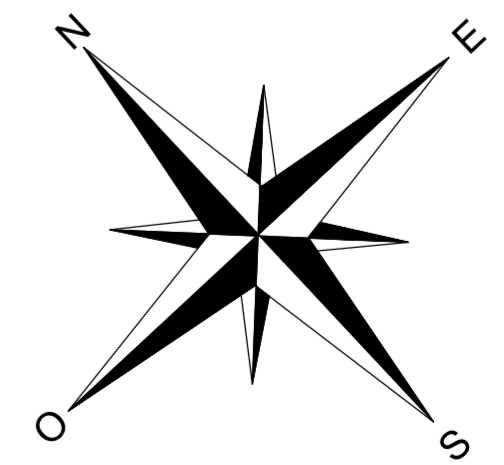

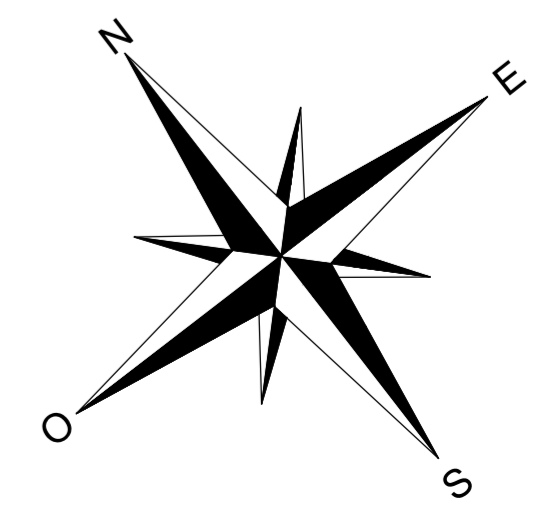
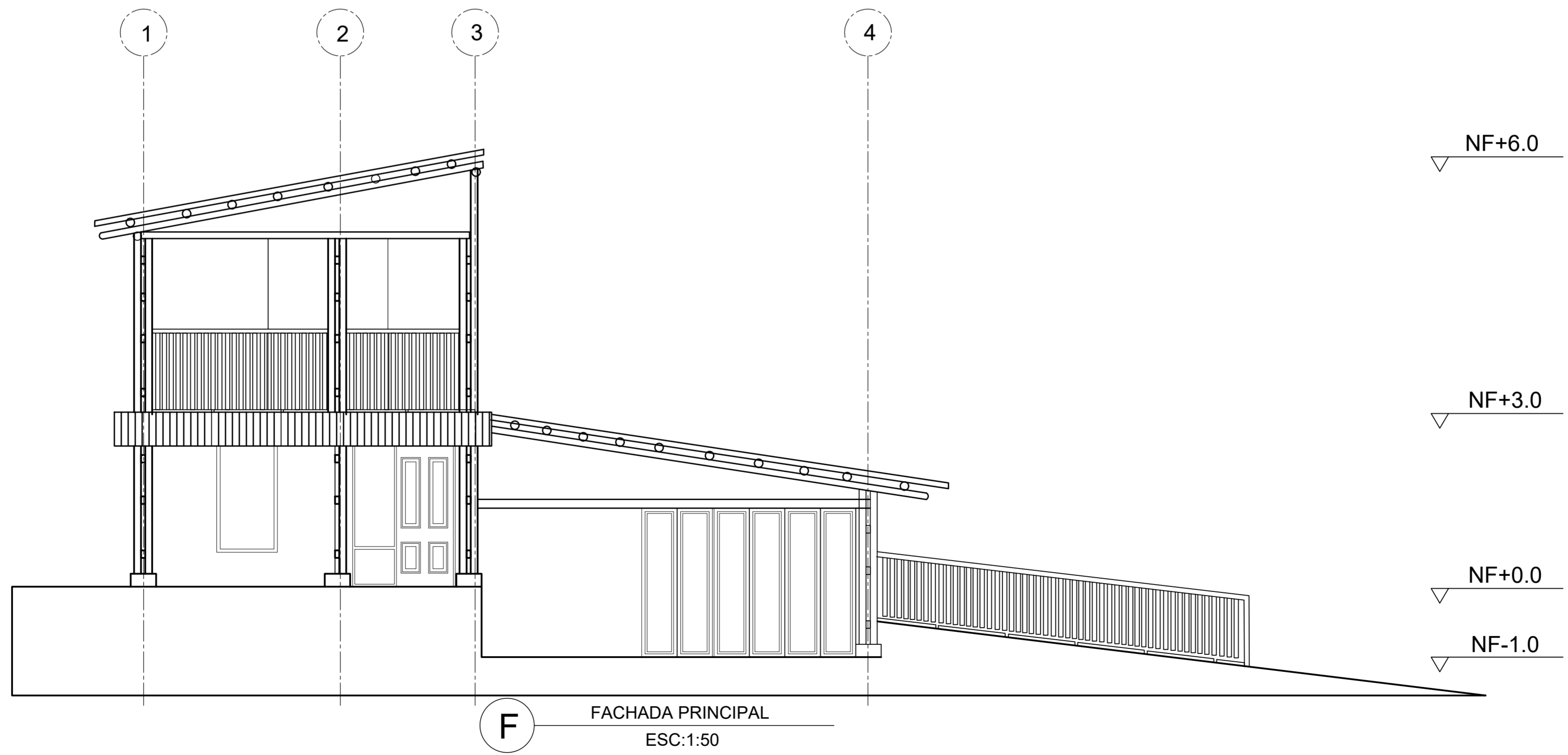
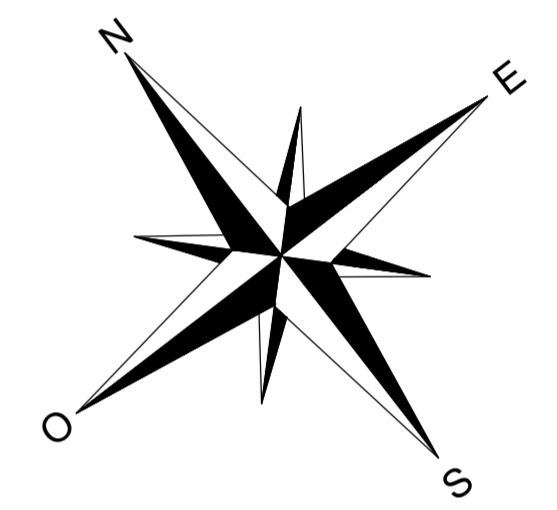
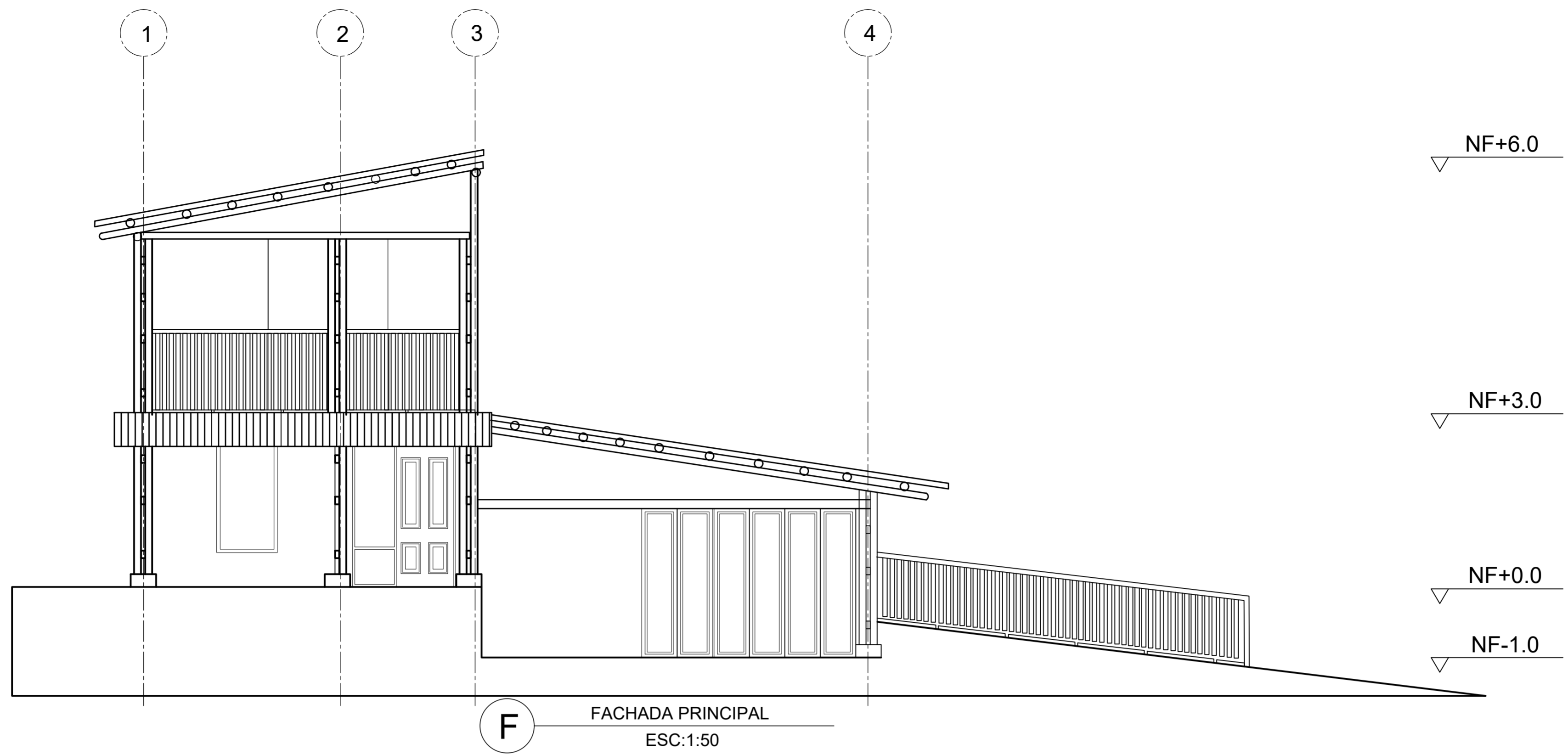

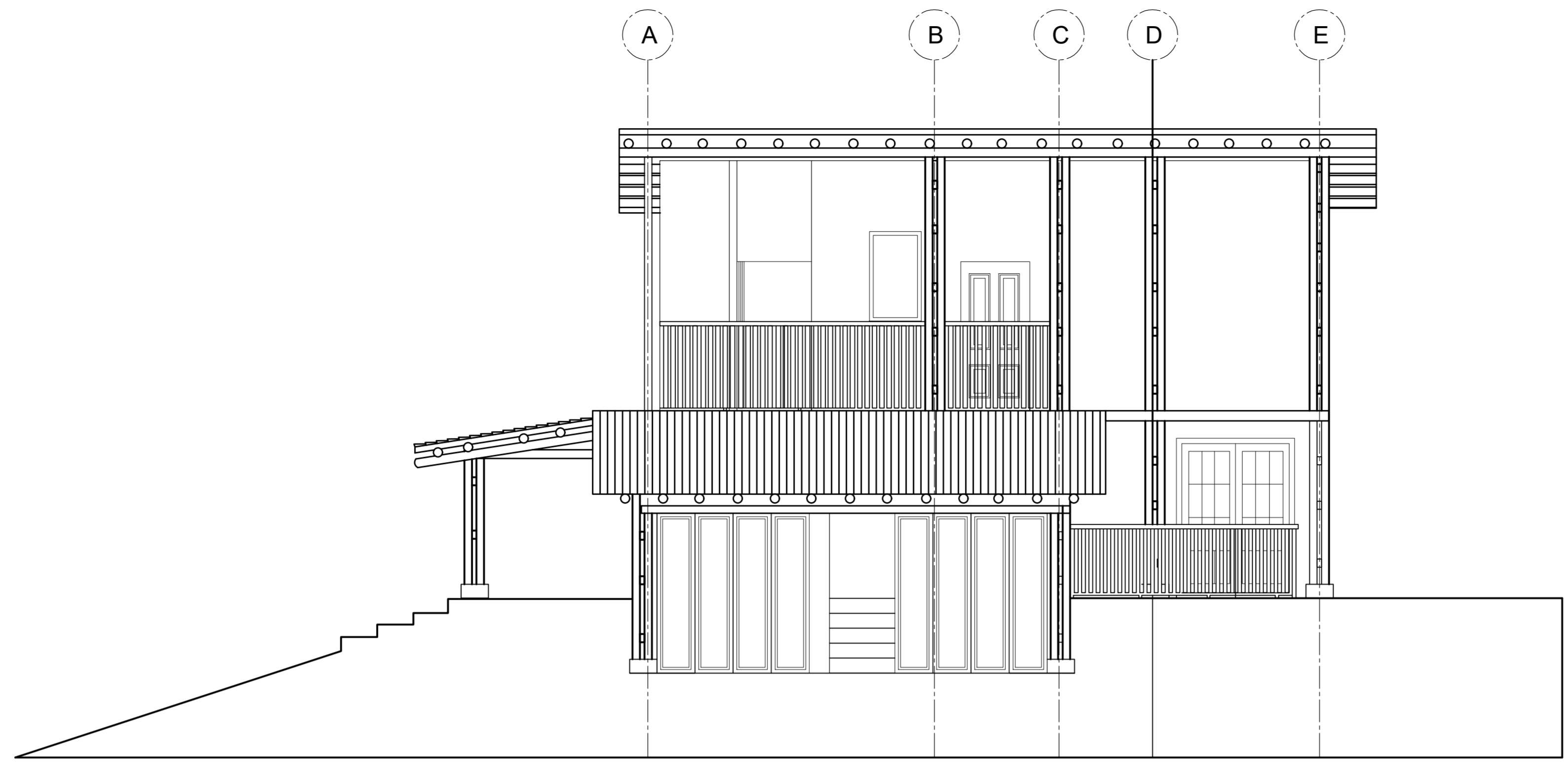

**F** FACHADA LATERAL DERECHA  
ESC:1:50

NF+6.0

NF+3.0

NF+0.0

NF-1.0

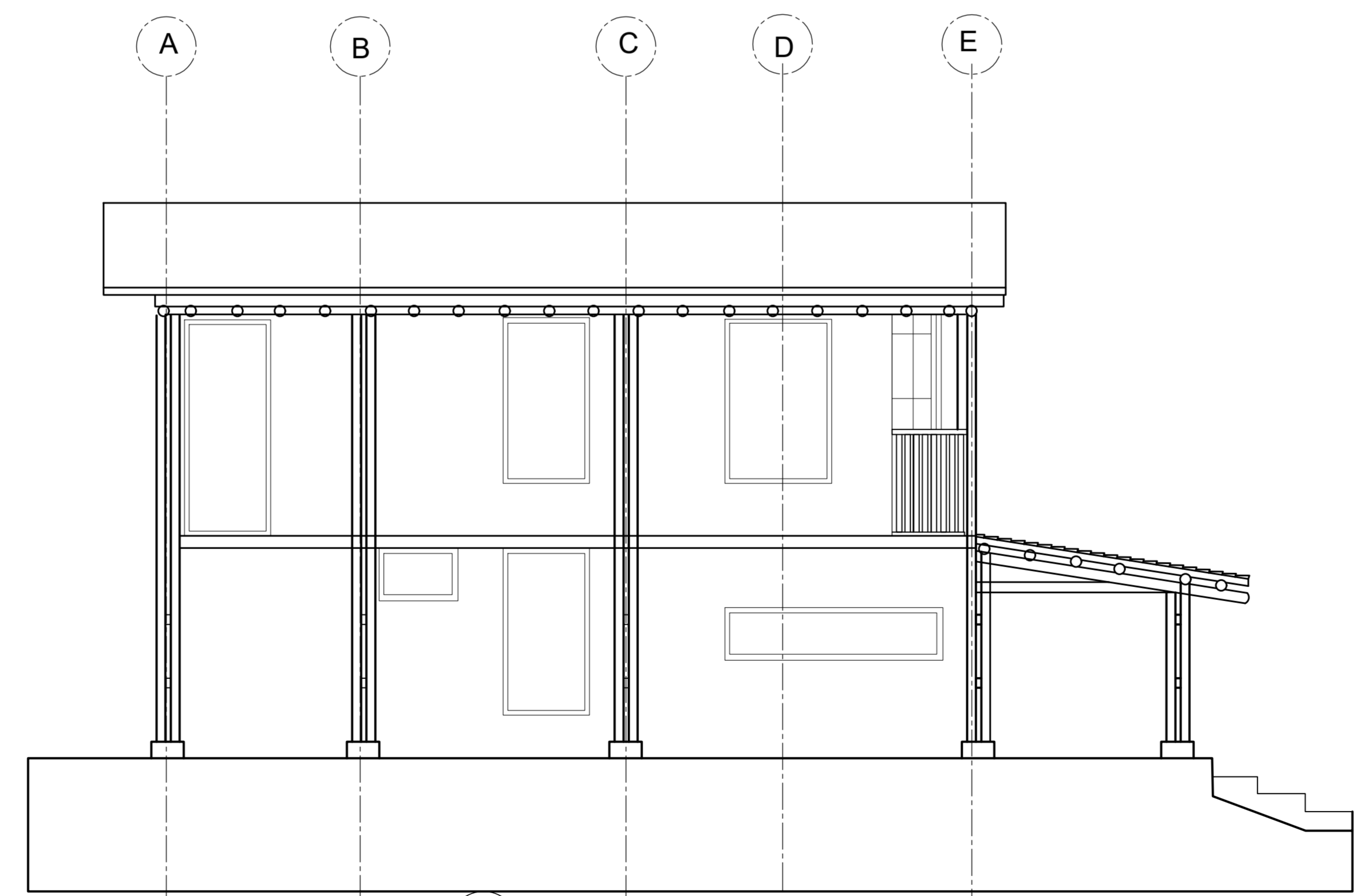
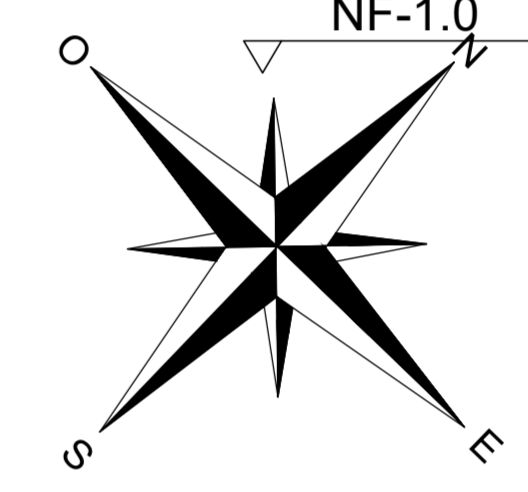

**F** FACHADA LATERAL IZQUIERDA  
ESC:1:50

NF+6.0

NF+3.0

NF+0.0

NF-1.0

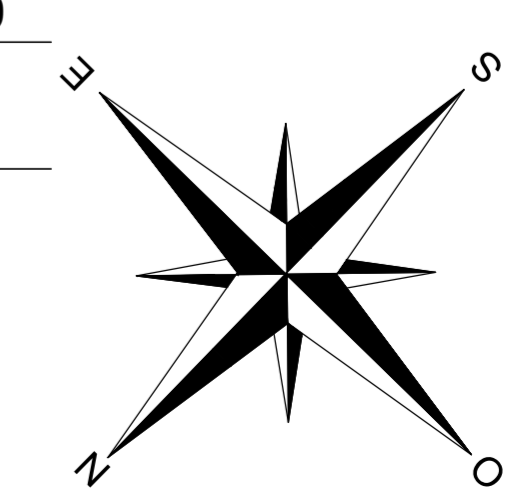

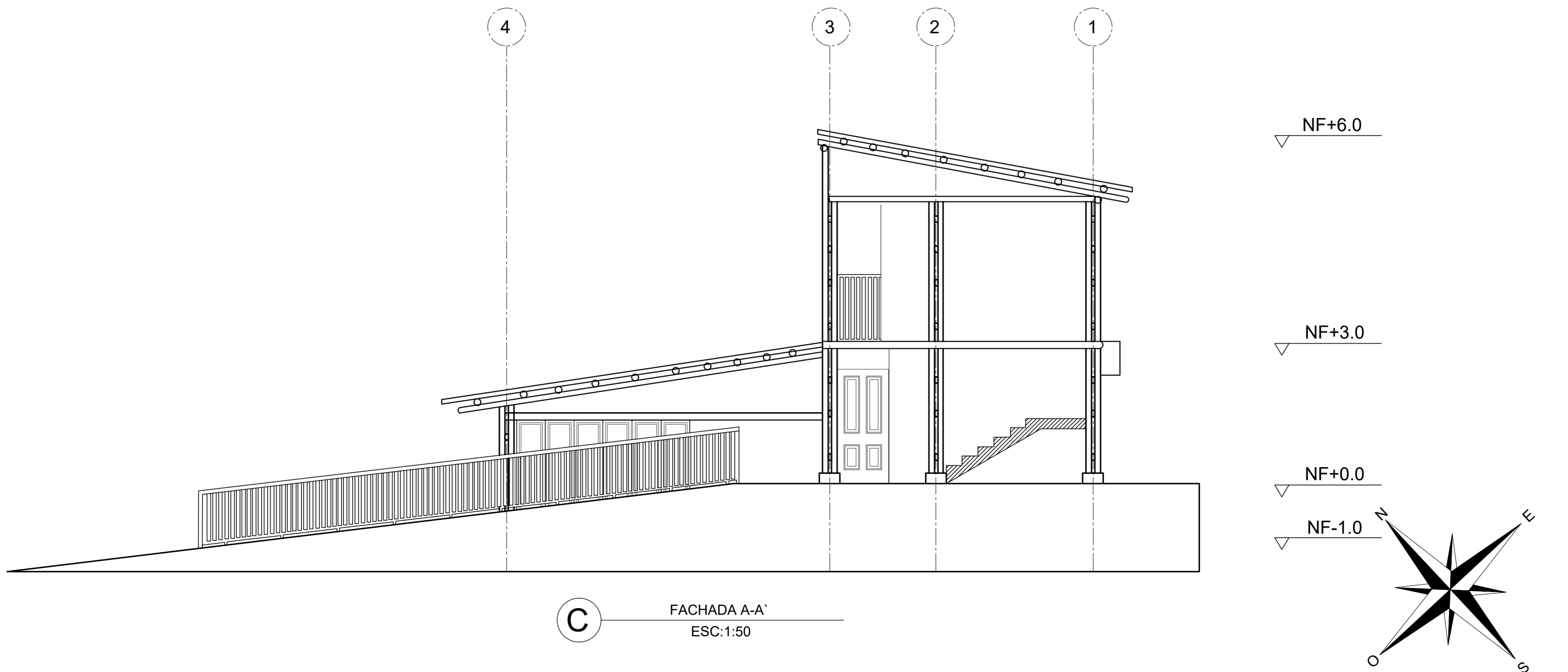
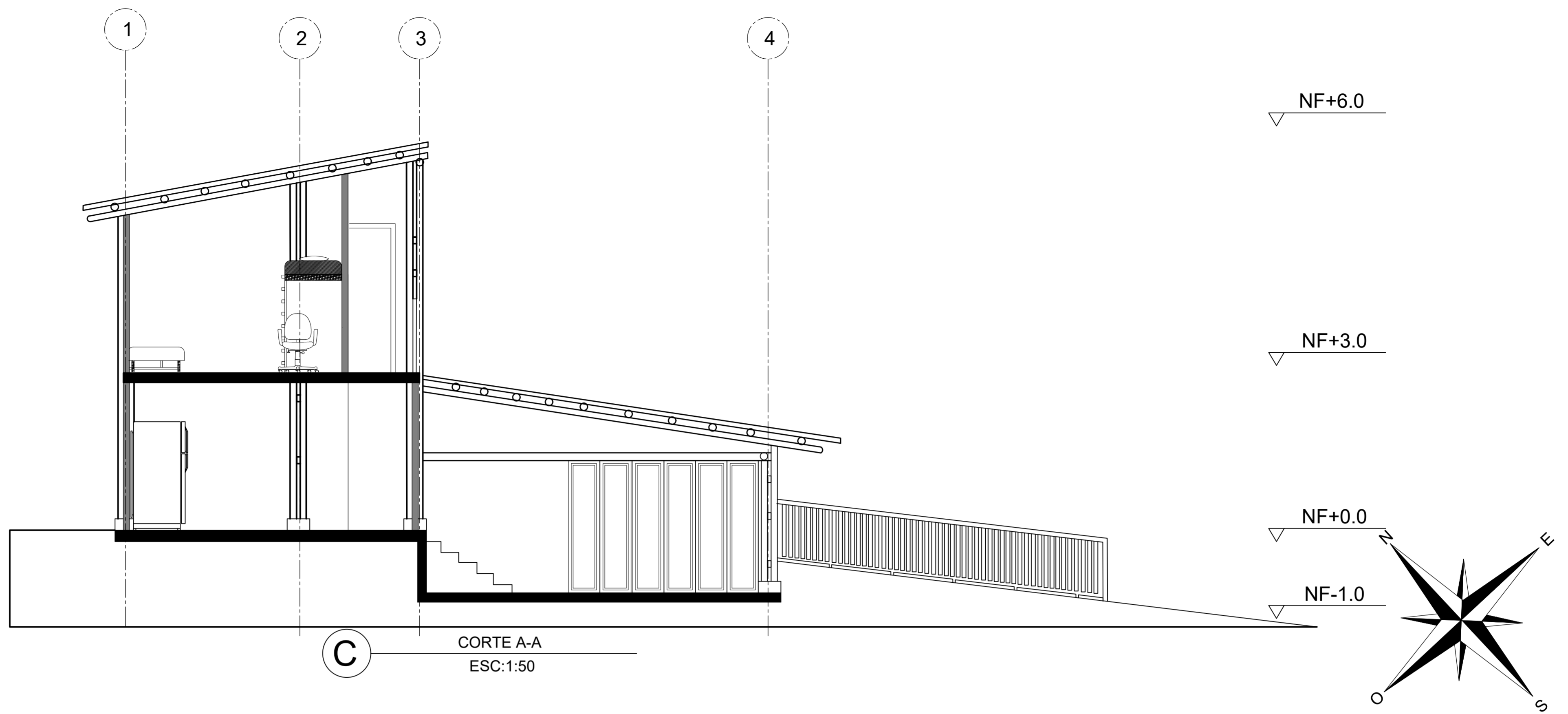

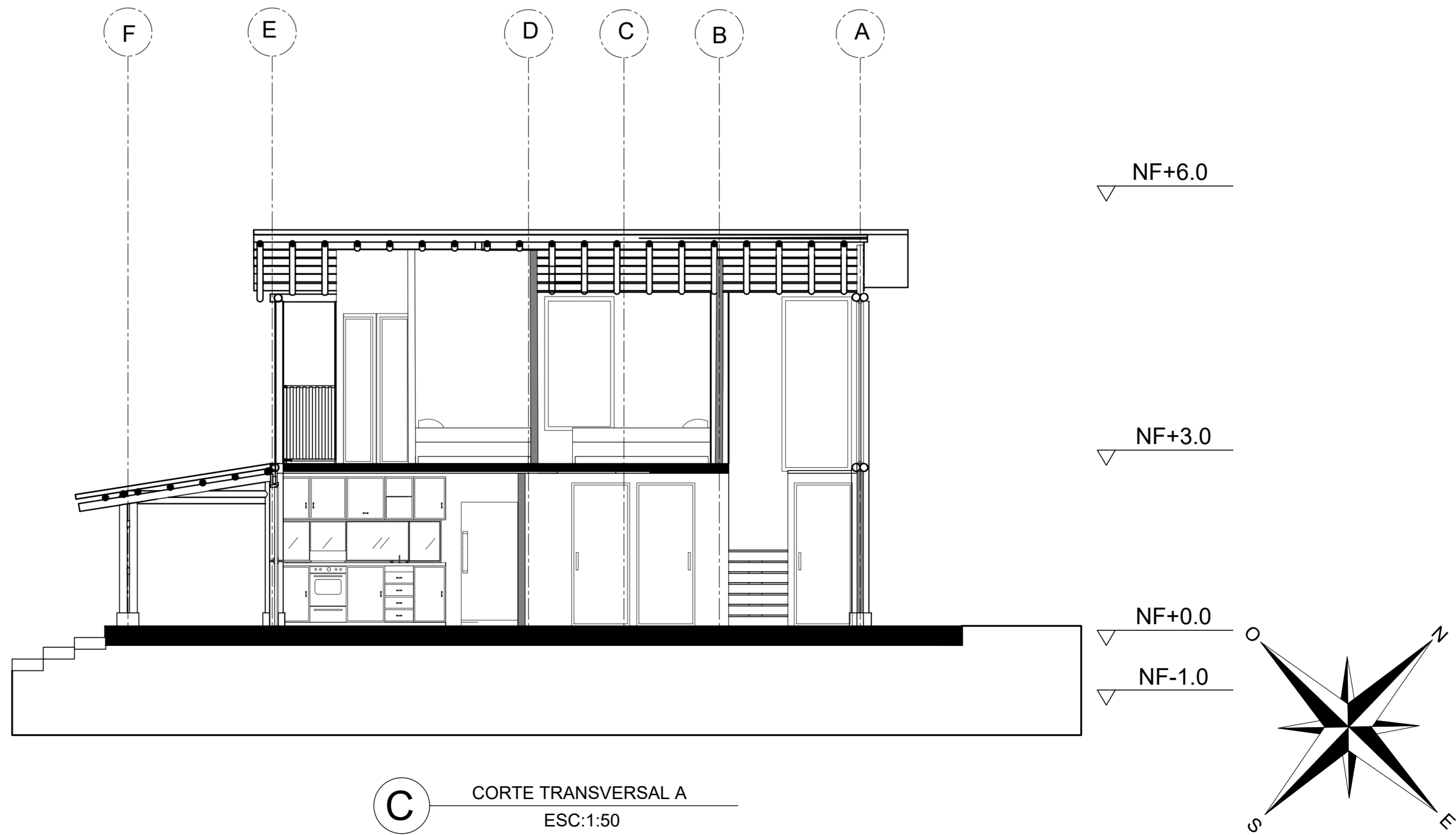
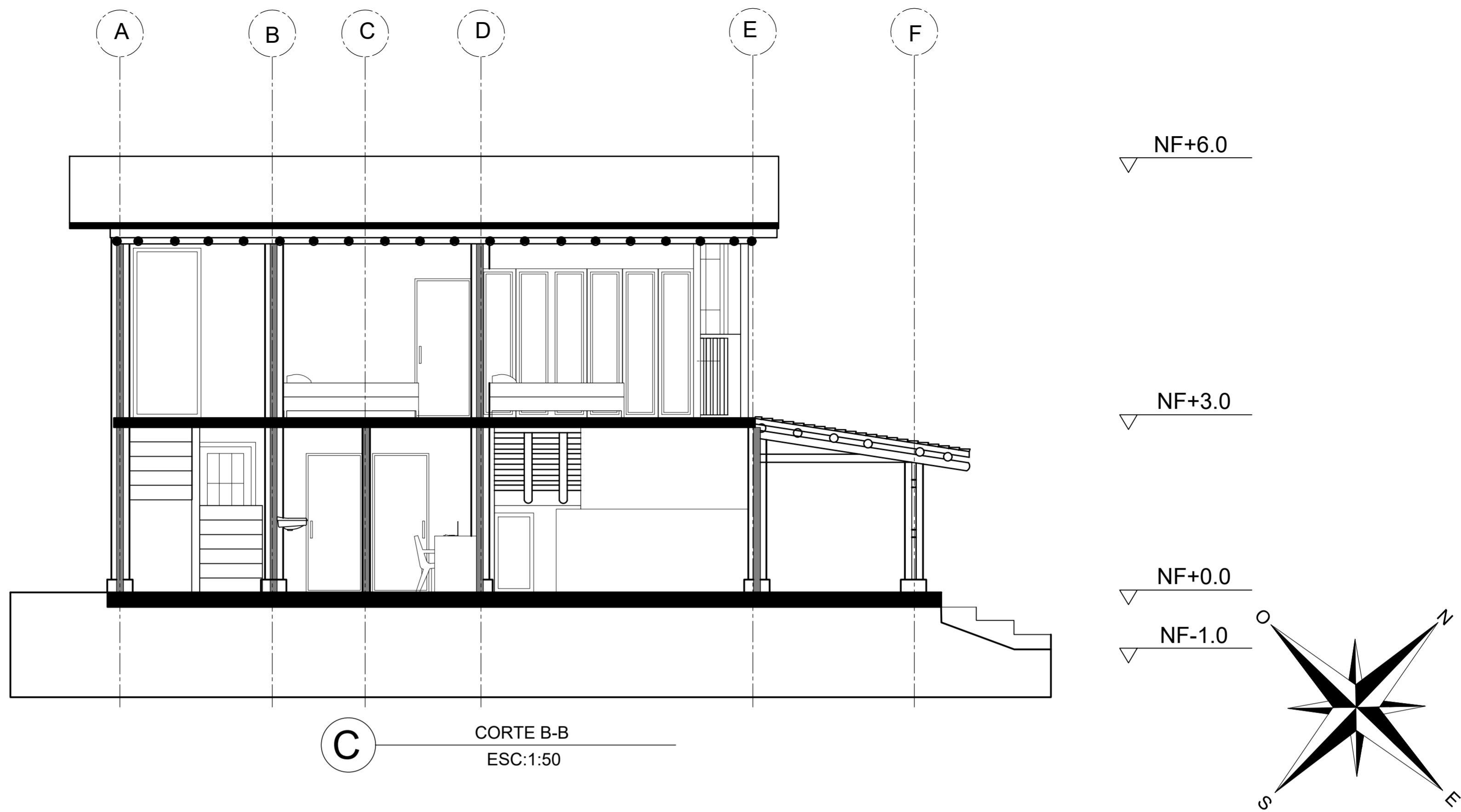

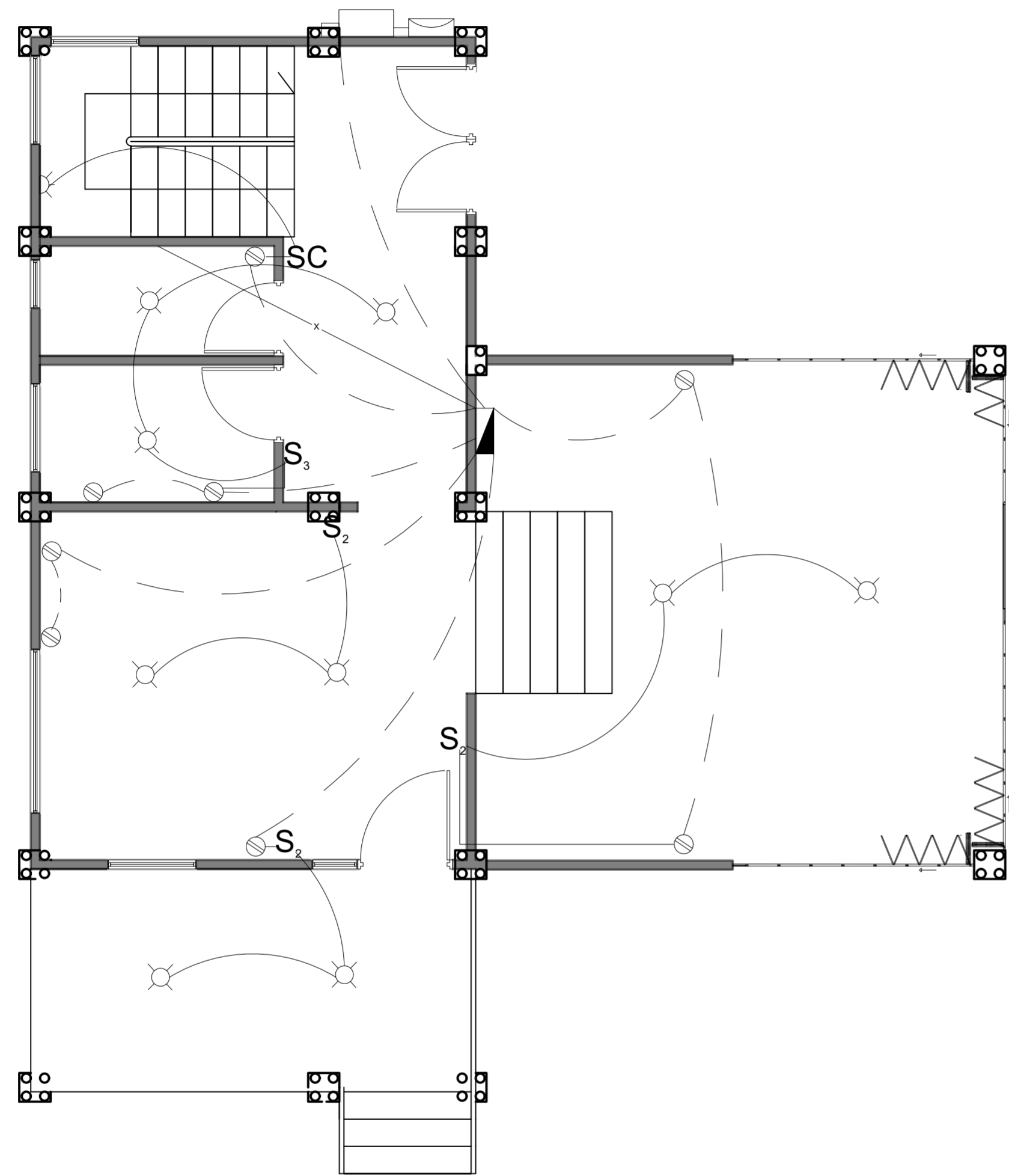

CONVENCION DE REDES, ACCESORIOS Y APARATOS ELECTRICOS

	SWITCH GENERAL
	MEDIDOR DE LUZ
	TABLERO DE BRAKERS
	SALIDA ROSETA
	TOMA DOBLE
	TOMA SENCILLA
	TOMA DOBLE
	TOMA TRIPLE
	TUBERIA BAJA
	TUBERIA ALTA
	TUBERIA TOMA A INTERRUPTOR

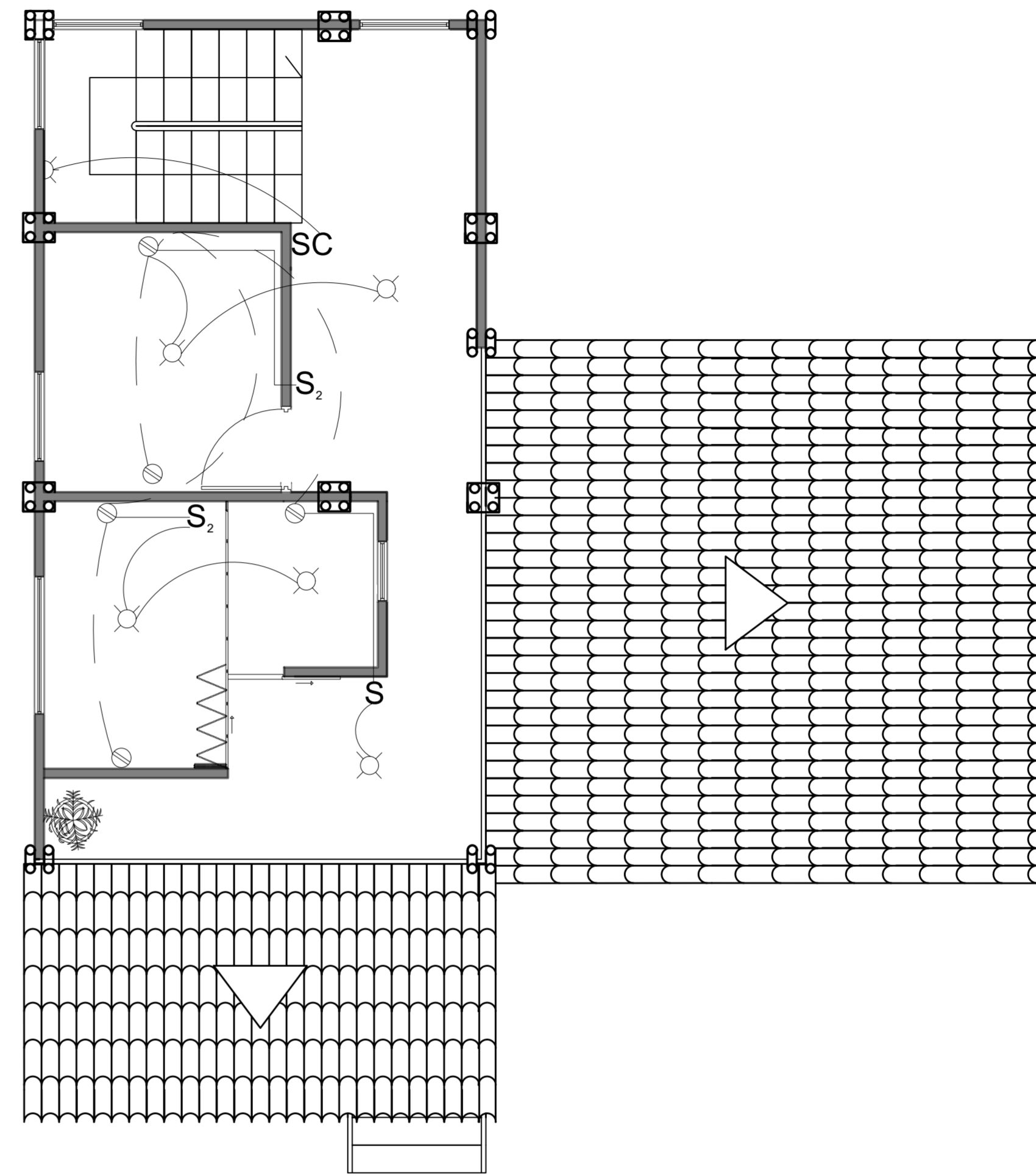

**L** INSTALACIONES ELECTRICAS  
ESC:1:50

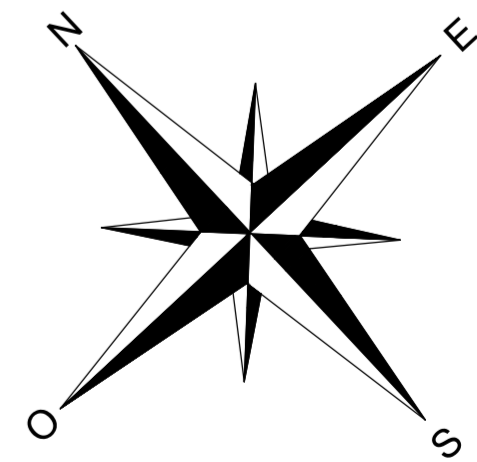

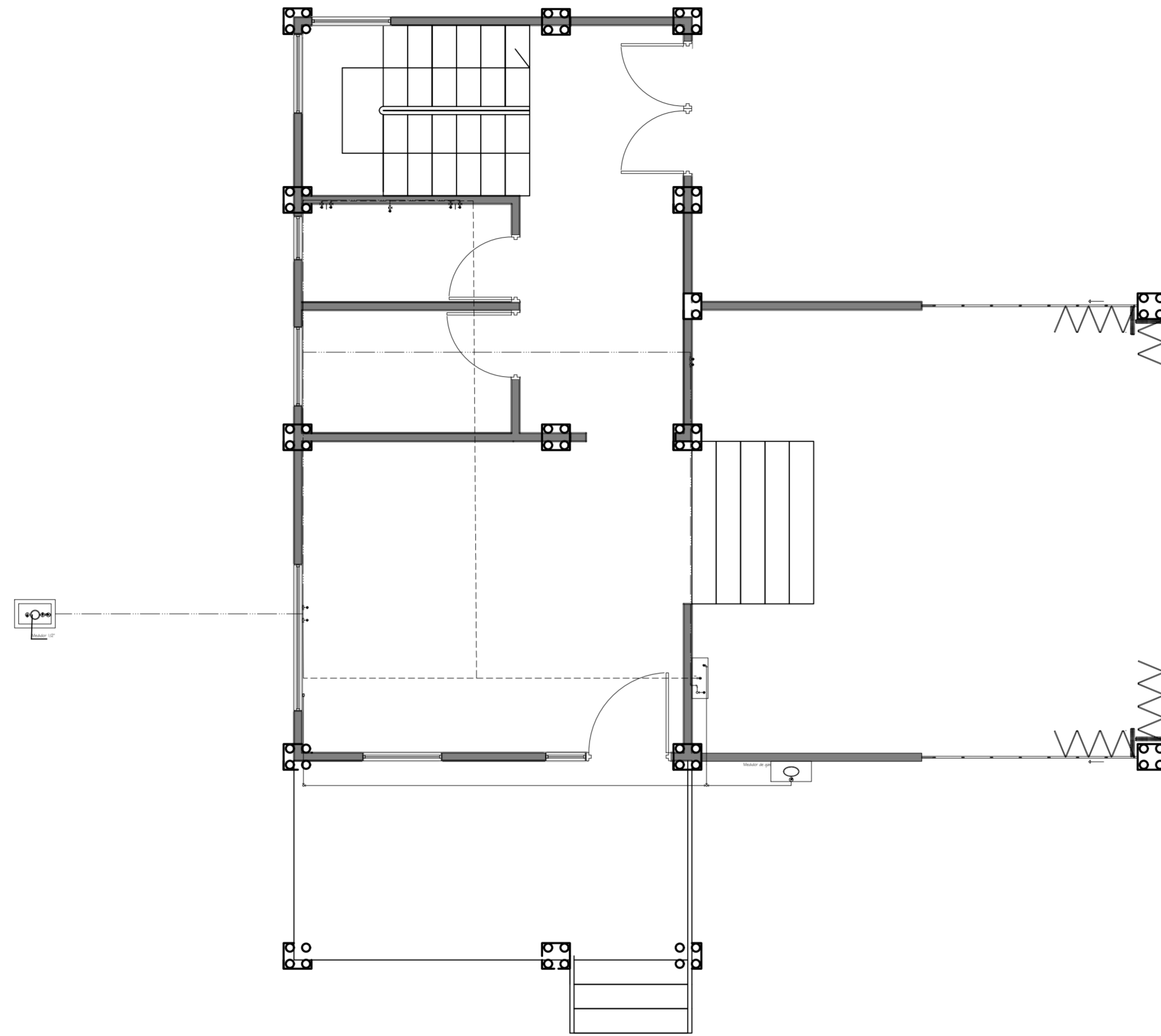

CONVENCION DE REDES, ACCESORIOS Y APARATOS HIDRAULICOS Y DE GAS	
	LLAVES SUMINISTRO
	MEDIDOR
	VALBULA DE BOLA
	TUBERIA AGUA CALIENTE
	TUBERIA AGUA FRIA
	TUBERIA DE GAS
	TEE COBRE PARA GAS
	CODO 90° COBRE PARA GAS
	PUNTO DE GAS
	CODO 90°
	CALENTADOR DE AGUA
	MEDIDOR DE GAS

**H** INSTALACIONES HIDRAULICAS  
ESC:1:50

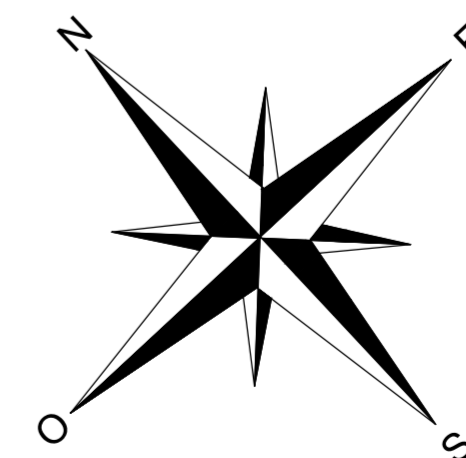

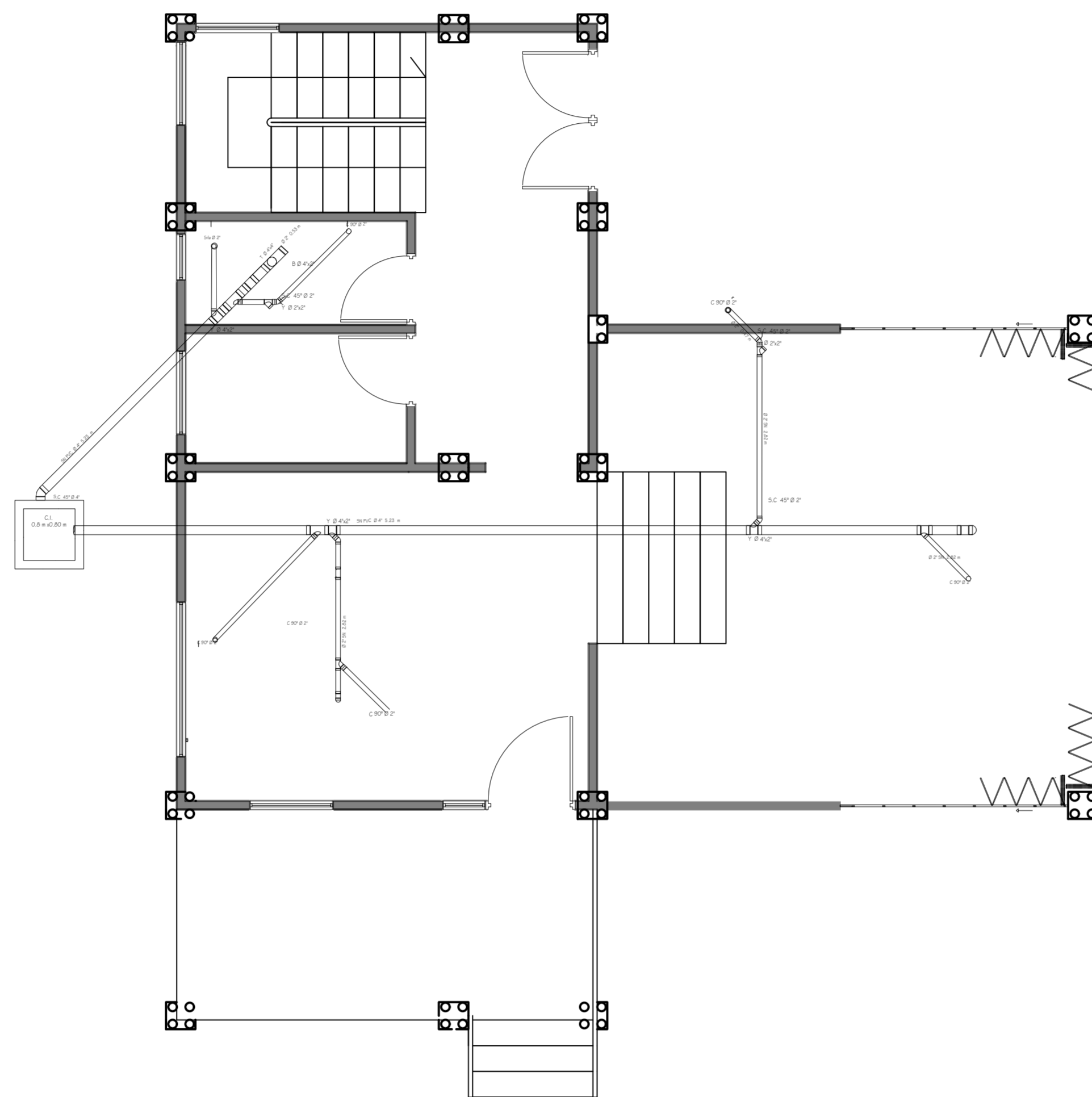

CONVENCION DE REDES, ACCESORIOS Y APARATOS SANITARIOS	
	CAJA DE INSPECCION
	CODO DE 45°
	YEE
	TEE

**Y** INSTALACIONES SANITARIAS  
 ESC:1:75

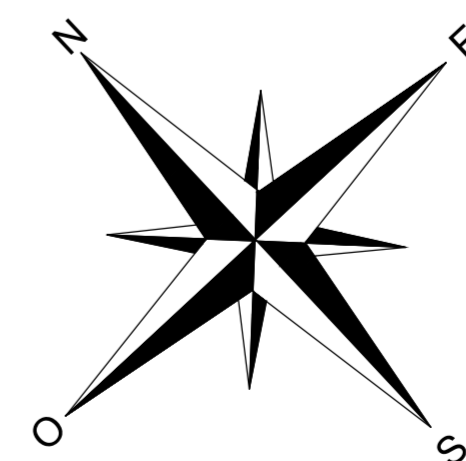

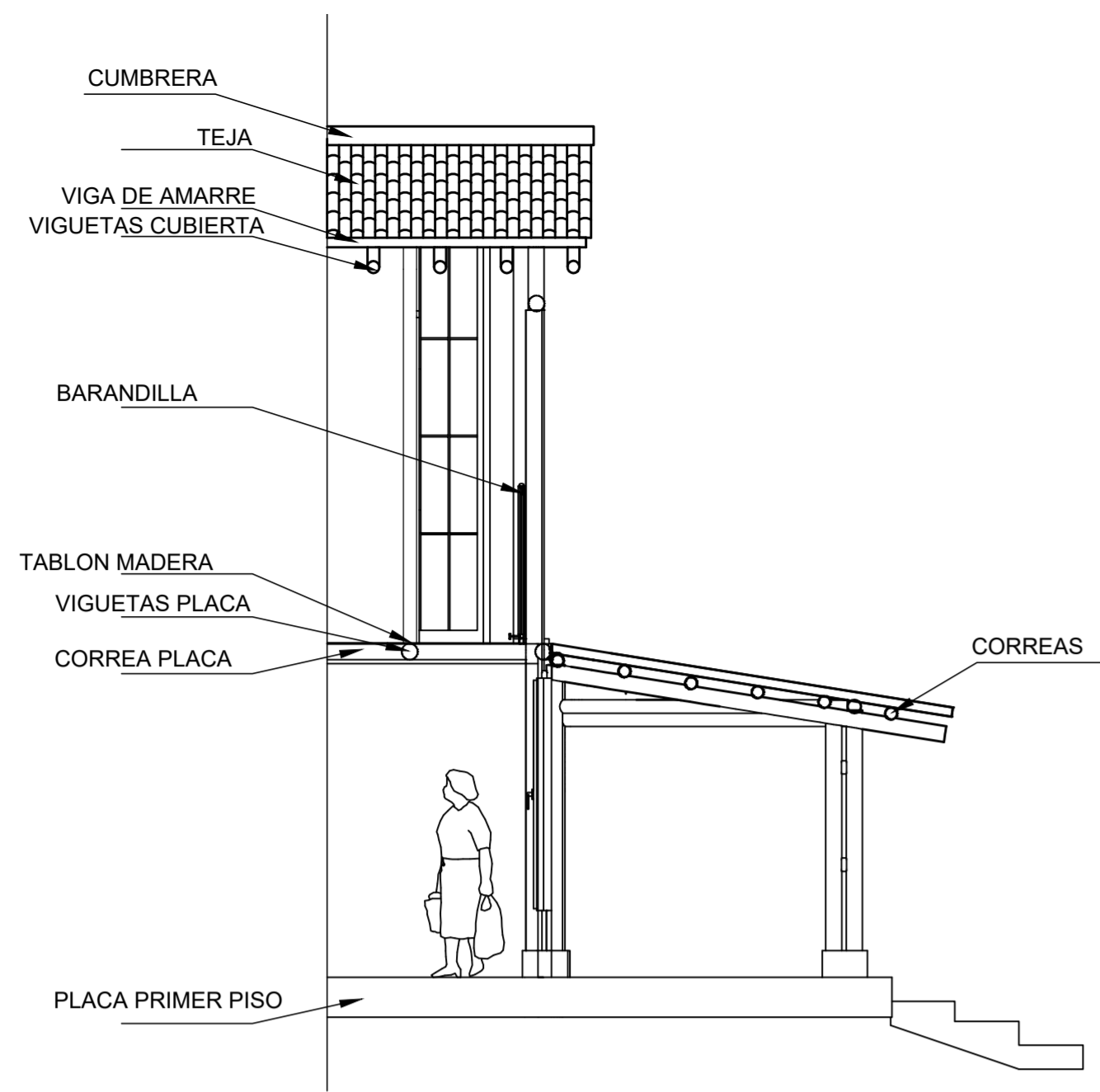

DT CORTE FACHADA  
ESC:1:50

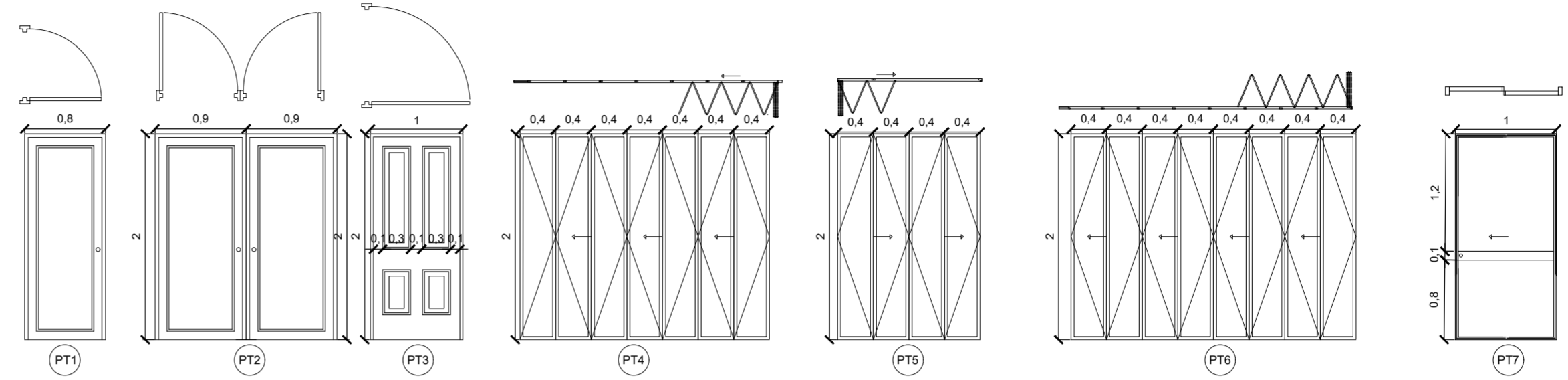

CUADRO DE PUERTAS										
	TIPO DE PUERTAS	DIM. ANCHO	DIM. ALTO	CANTIDAD	DERECHA	IZQUIERDA	MARCO	CERRADURA	LOCALIZACIÓN	
PUERTA 1	Madera batiente	0.8 m	2 m	2	1	1	MDF	Bronce	Estudio, Baño	
PUERTA 2	Madera batiente	1.8 m	2 m	1			Cedro	Bronce	Frete escaleras	
PUERTA 3	Madera batiente	1 m	2 m	1	1		Cedro	Bronce	Acceso	
PUERTA 4	Madera plegable	2.8 m	2 m	3	2	1	Madera	Bronce	Produccion	
PUERTA 5	Madera plegable	1.6 m	2 m	1		1	Madera	Bronce	Produccion	
PUERTA 6	Madera plegable	3.2 m	2 m	1		1	Madera	Bronce	Produccion	
PUERTA 7	Madera corredera	1 m	2 m	1		1	Madera	Bronce	Habitacion flexible	

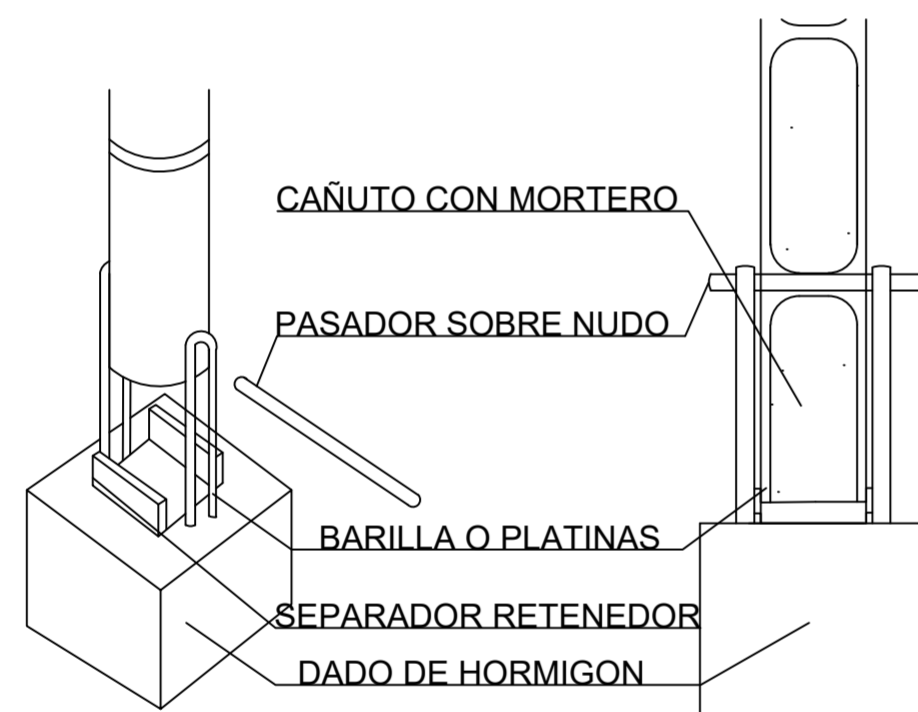

DT DETALLE BASE COLUMNA  
ESC:1:10

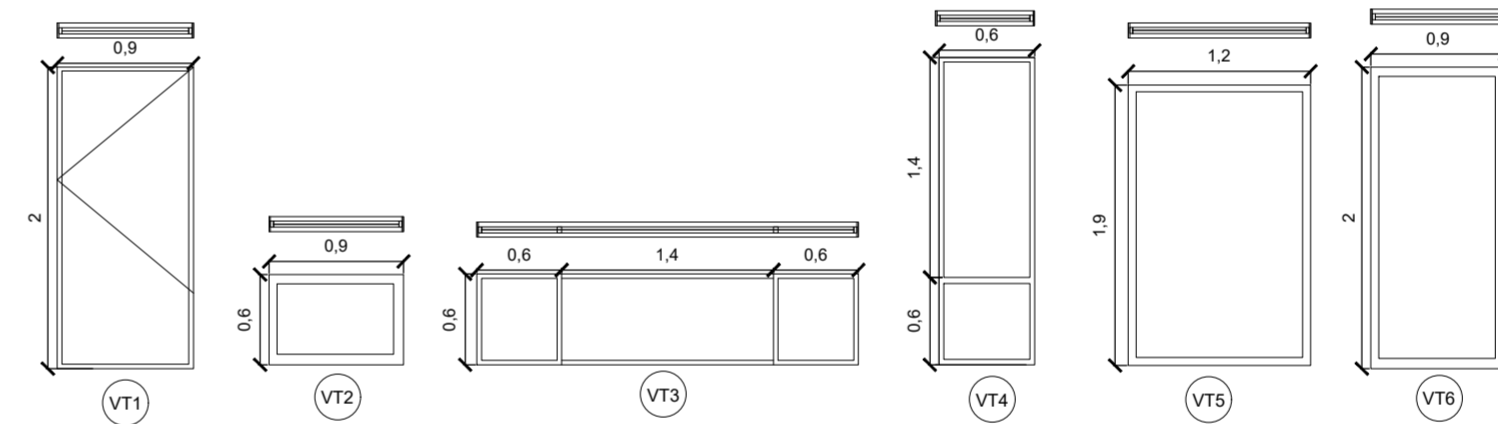

CUADRO DE VENTANAS											
	TIPO DE VENTANA	DIM. ANCHO	DIM. ALTO	BATIENTE DER.	BATIENTE IZQ.	BATIENTE SUP.	BATIENTE INF.	CANTIDAD	MARCO	CERRADURA	LOCALIZACIÓN
VENTANA 1	Ventanal 1	0.9 m	2 m	4	1			5	aluminio	Aluminio	Escalera, cocina, habitacion
VENTANA 2	Ventanal 2	0.9 m	0.6 m			1		1	aluminio	Aluminio	Baño
VENTANA 3	Ventana 3	2.6 m	0.6 m					1	aluminio	Aluminio	Cocina
VENTANA 4	Ventana 4	0.6 m	2 m					1	aluminio	Aluminio	Acceso
VENTANA 5	Ventana 5	2.6 m	0.6 m					1	aluminio	Aluminio	Cocina
VENTANA 6	Ventana 6	0.9 m	2 m	1				1	aluminio	Aluminio	Habitacion

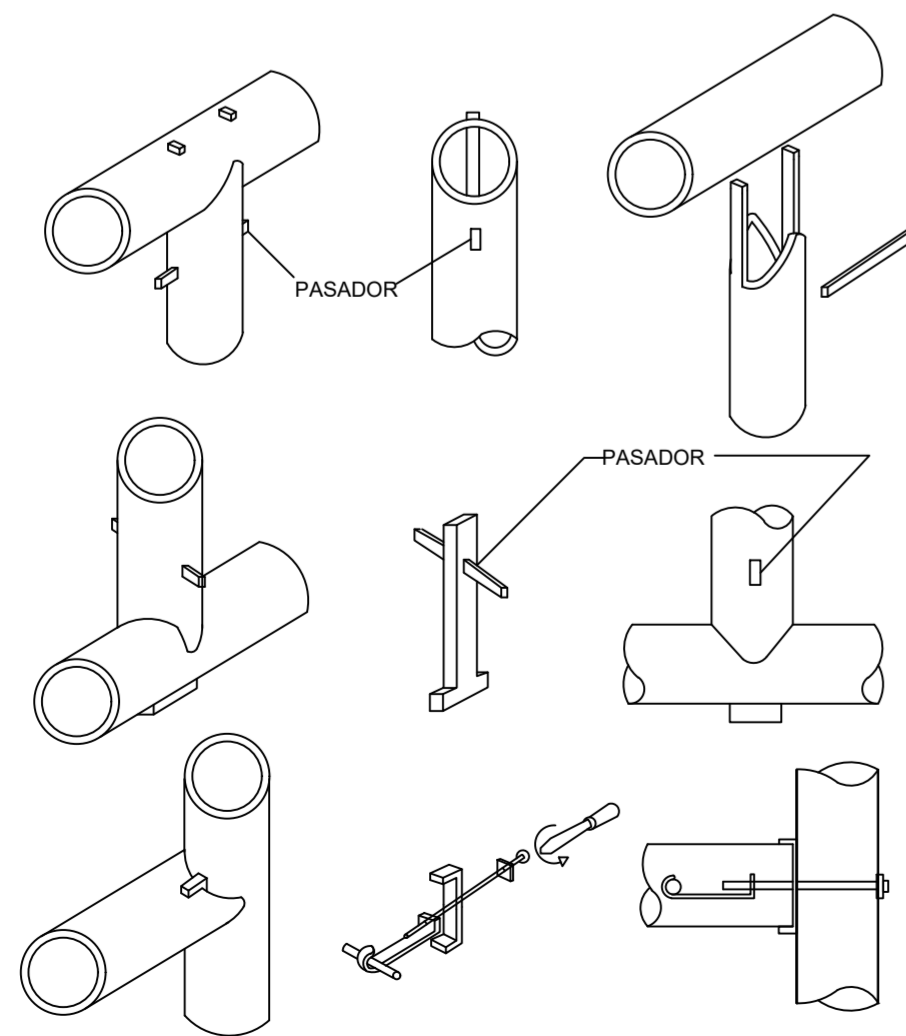

DT DETALLE UNIONES EN GUADUA  
ESC:1:10