

**REVITALIZACIÓN URBANA DEL ESPACIO
PÚBLICO DE FONTIBÓN**
EJE AMBIENTAL Y PEATONAL: CARRERA 100 Y LA
CARRERA 99 ENTRE AV. FERROCARRIL Y EL PARQUE
CENTRAL

Línea de Investigación
Desarrollo Urbano Regional Sostenible

Categoría del Proyecto
Proyecto urbano

Énfasis del Proyecto
Diseño Urbano y del Paisaje



UNIVERSIDAD
La Gran Colombia

BOOK DE PLANOS

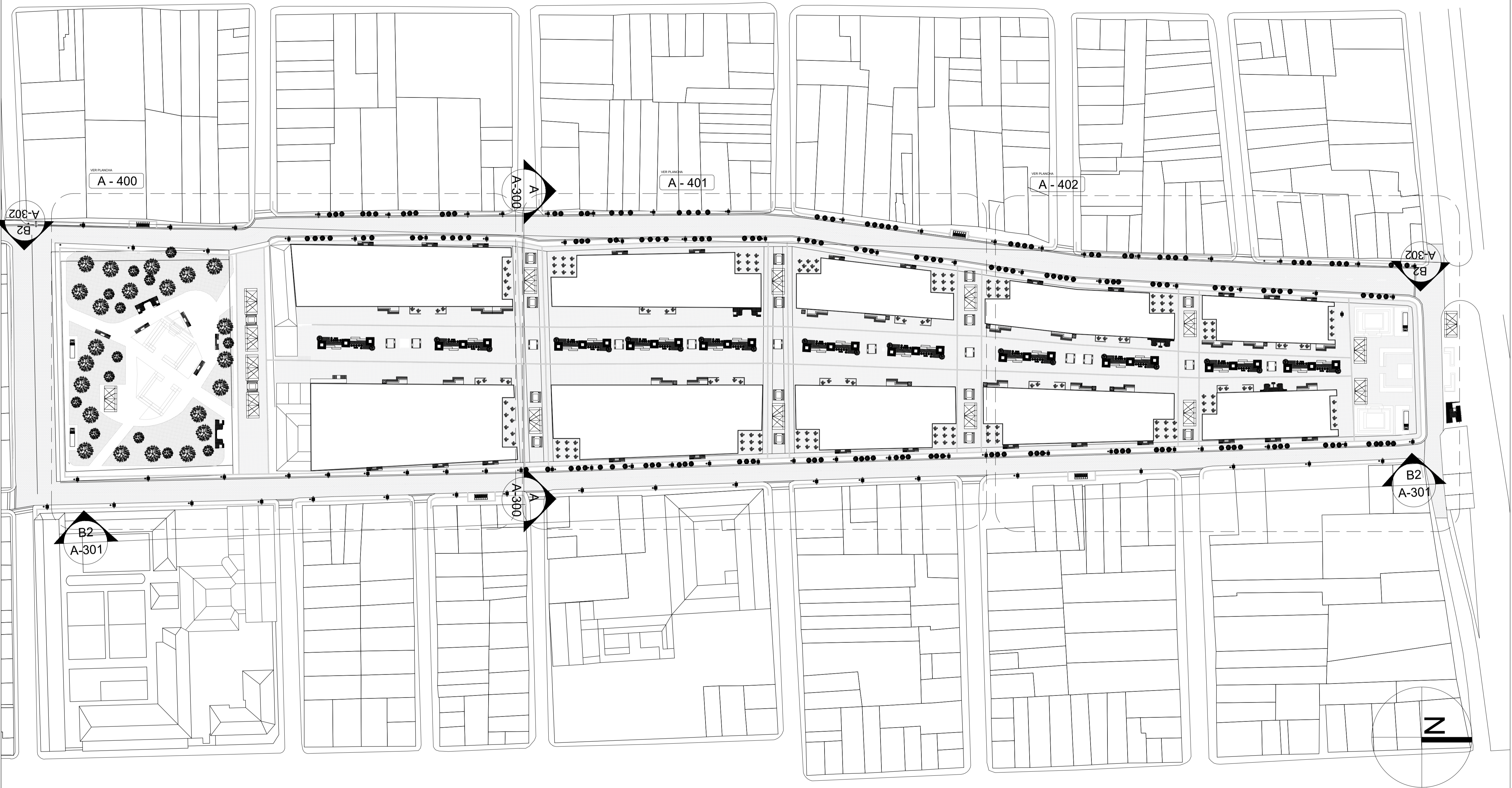

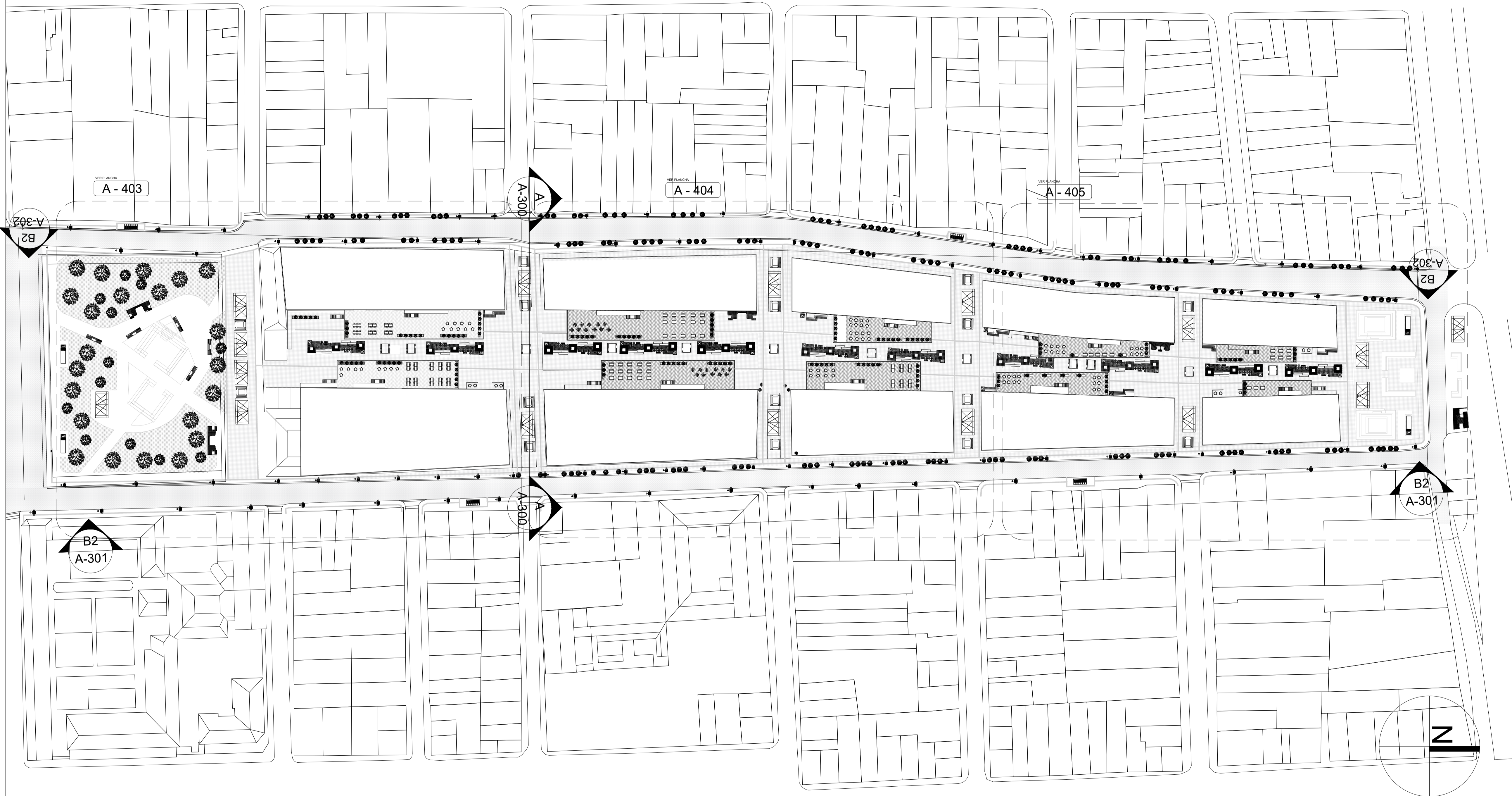

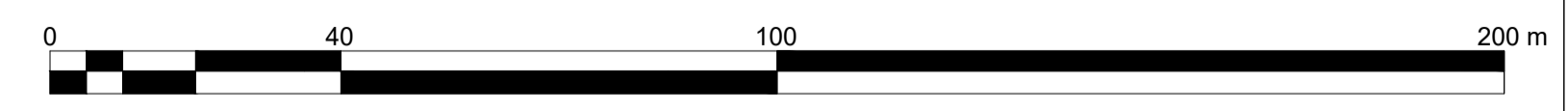
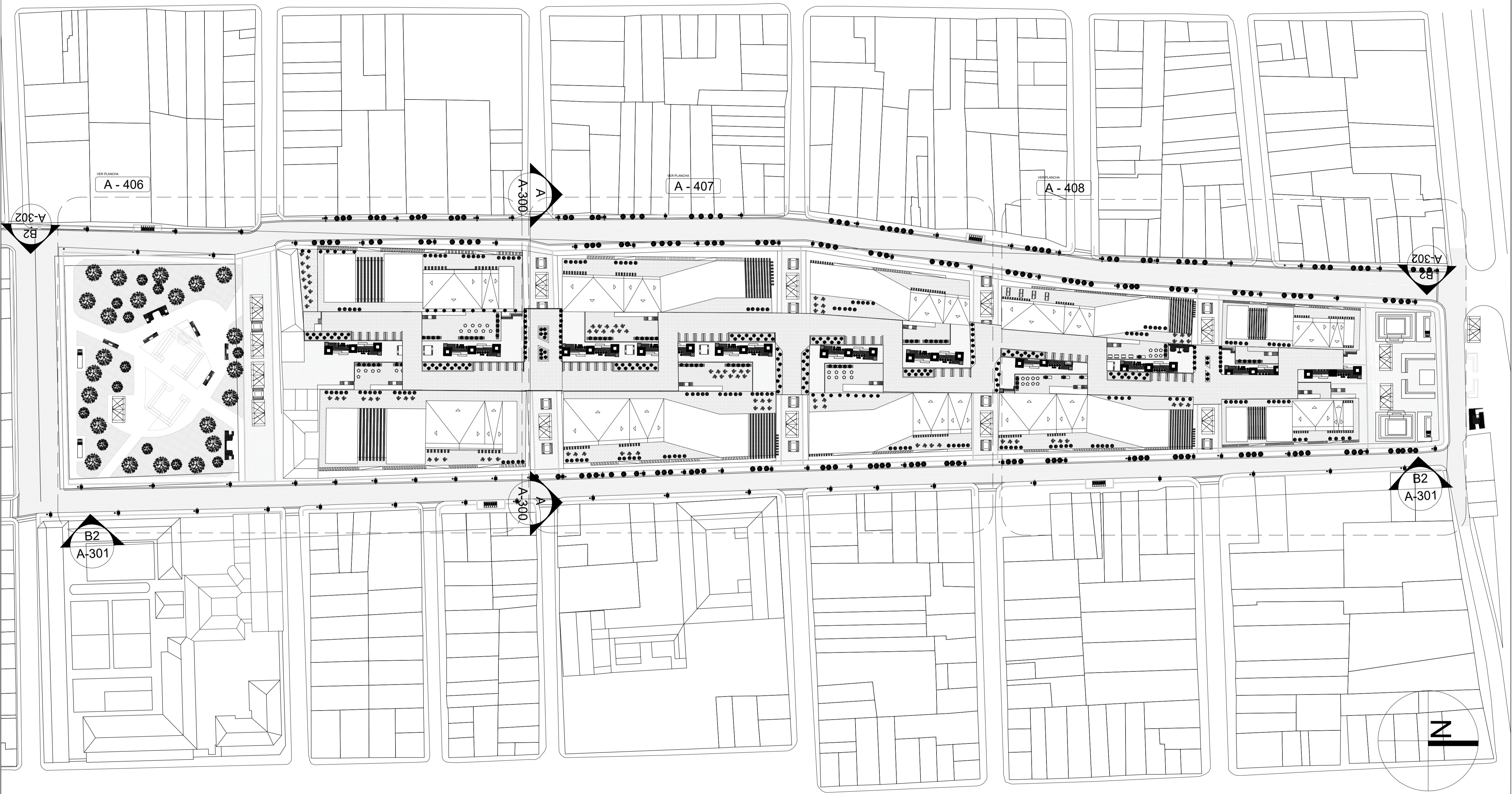

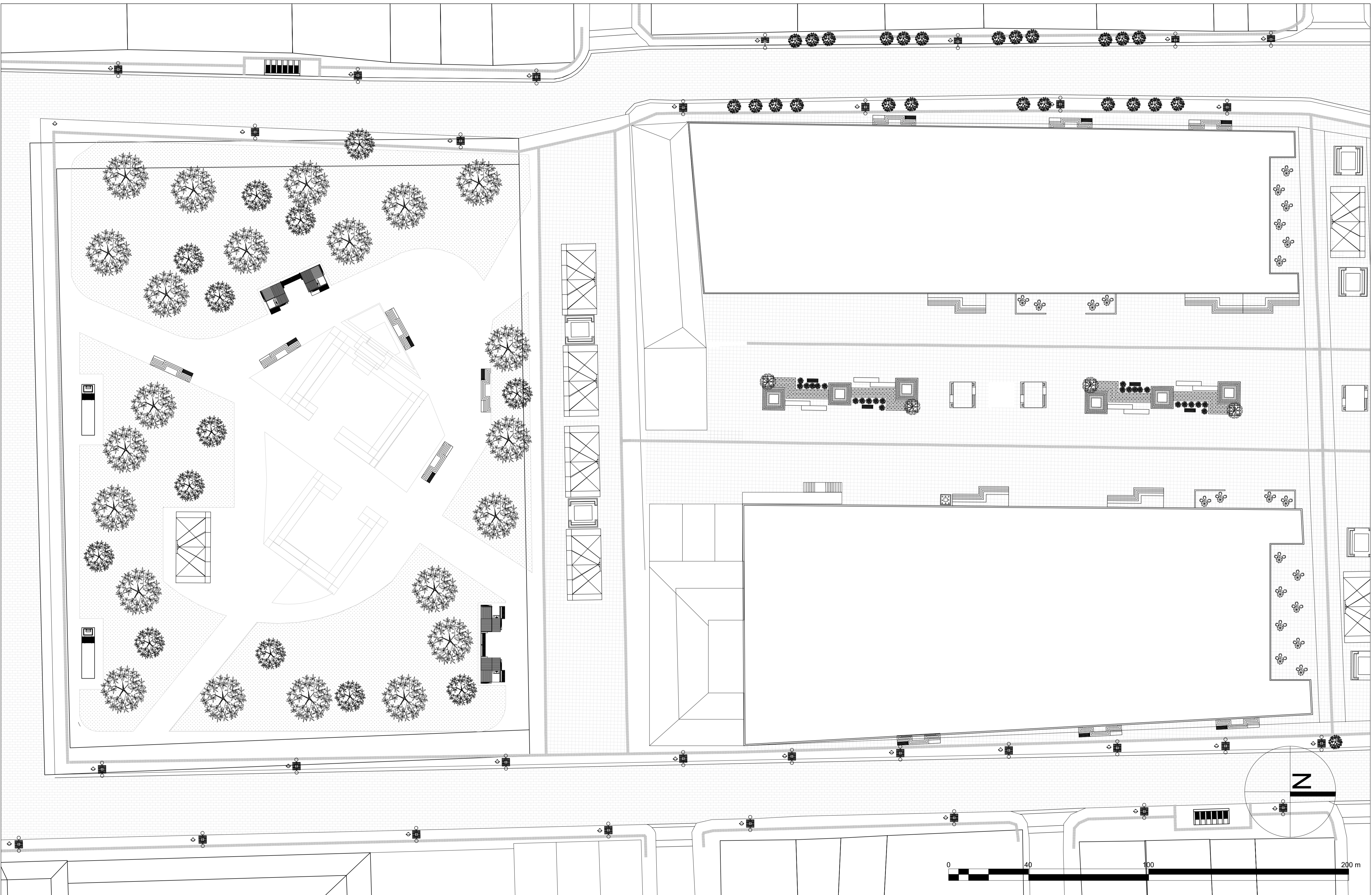

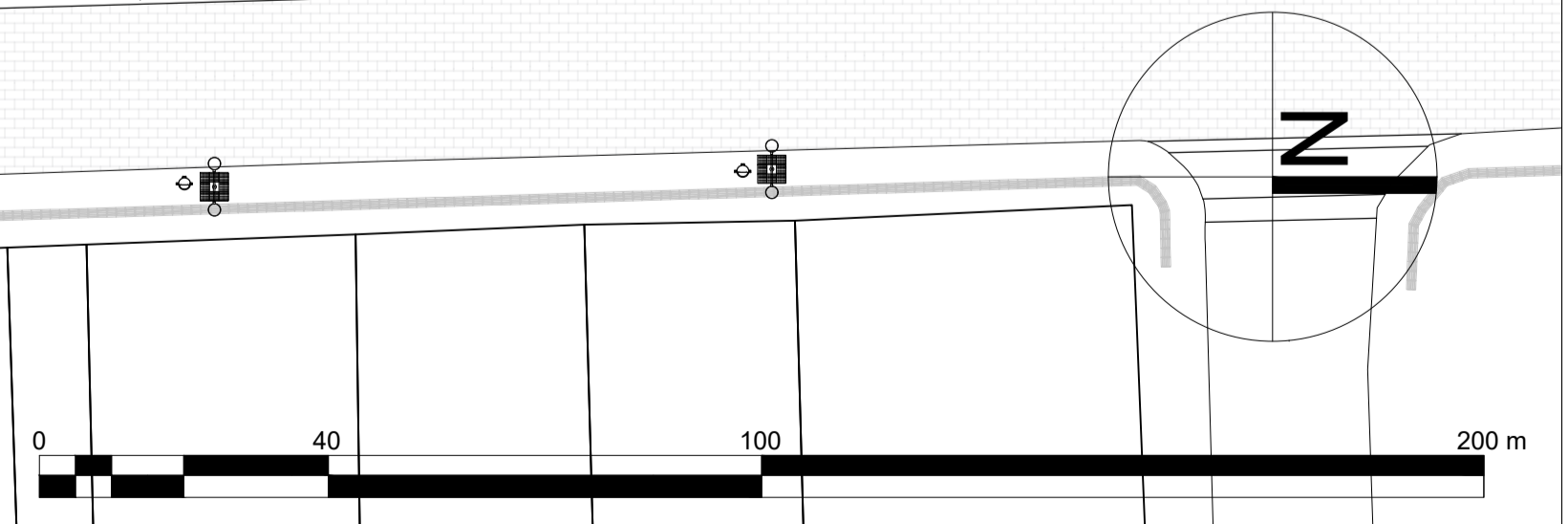



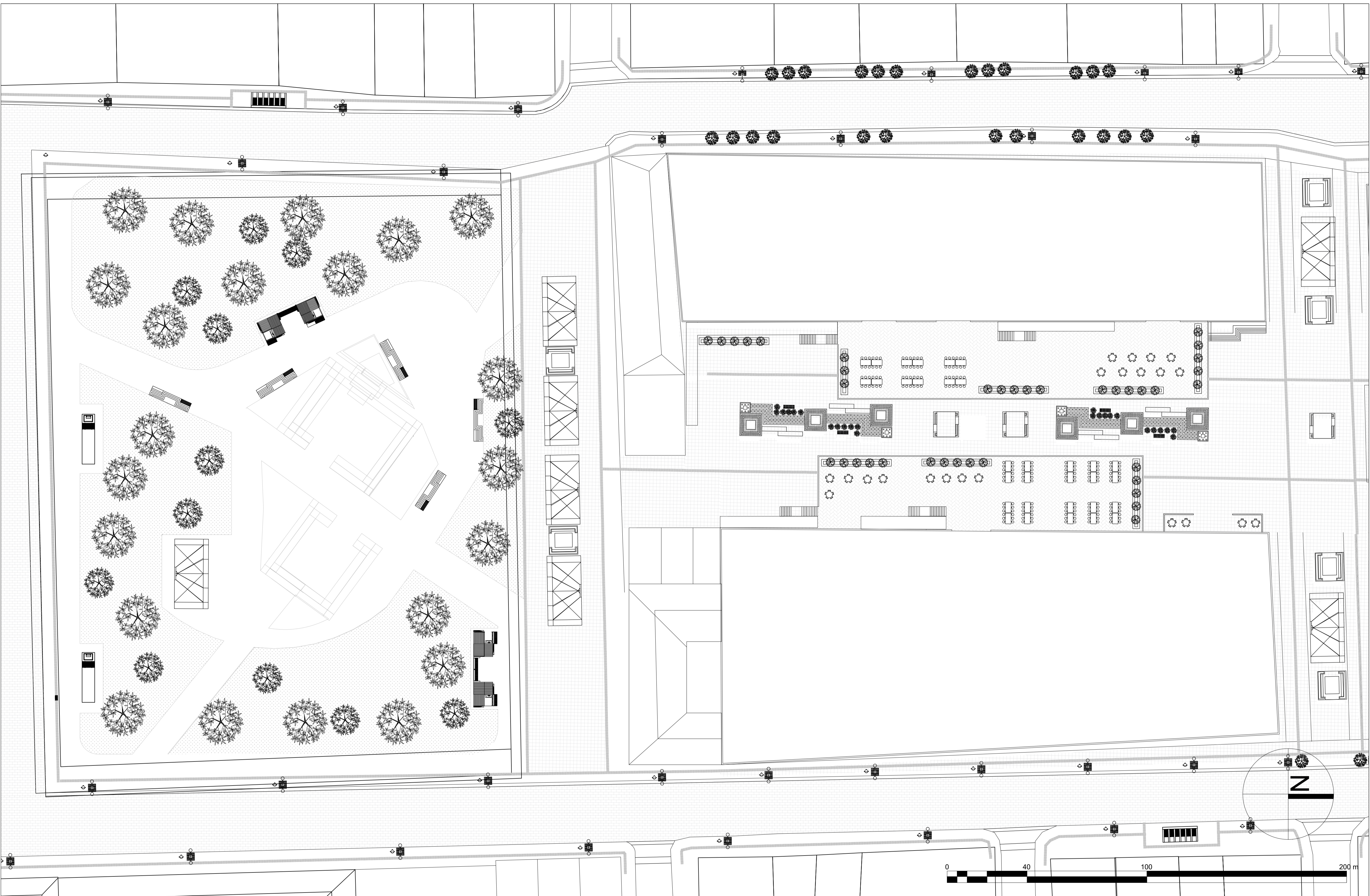



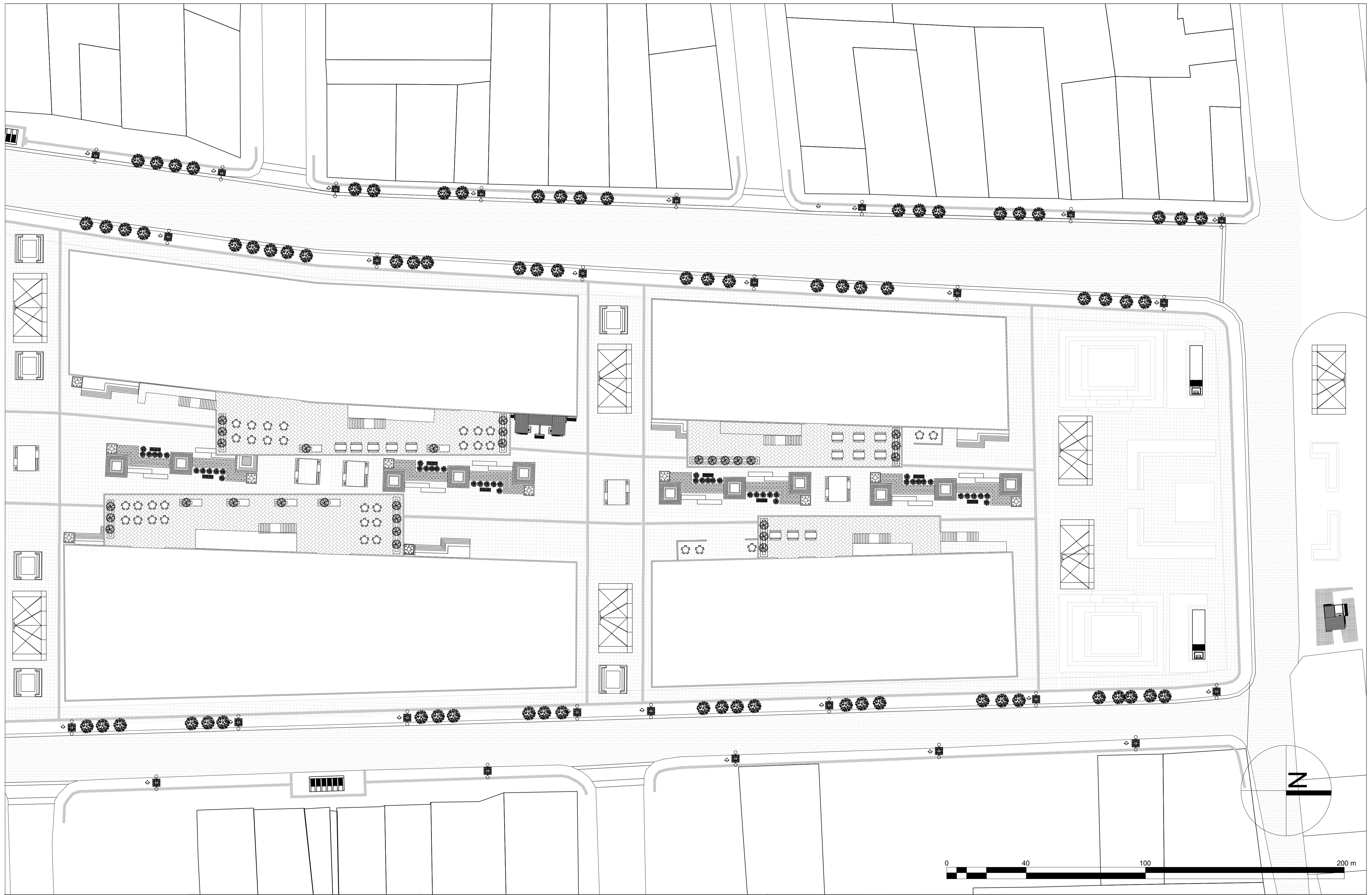

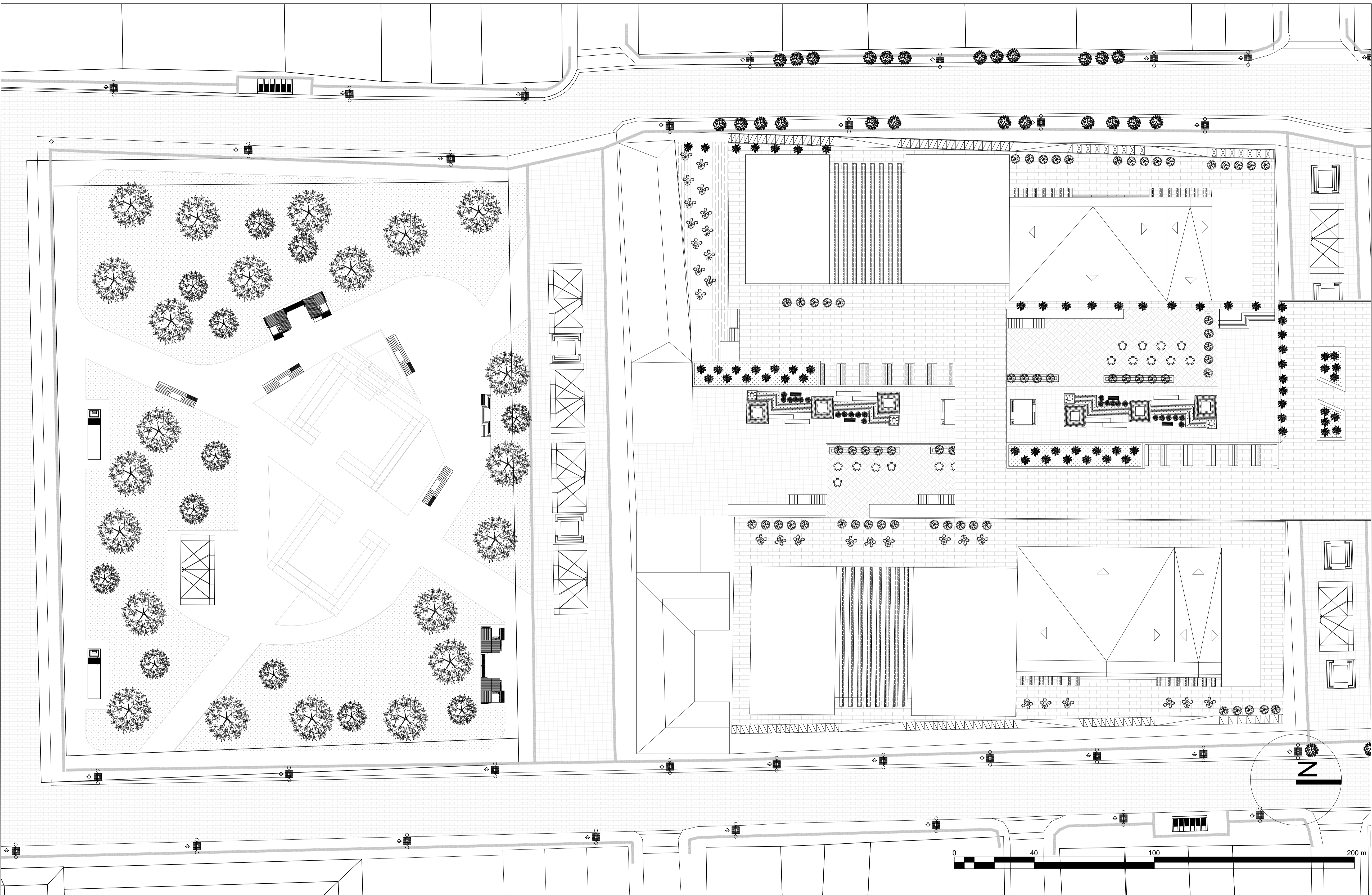

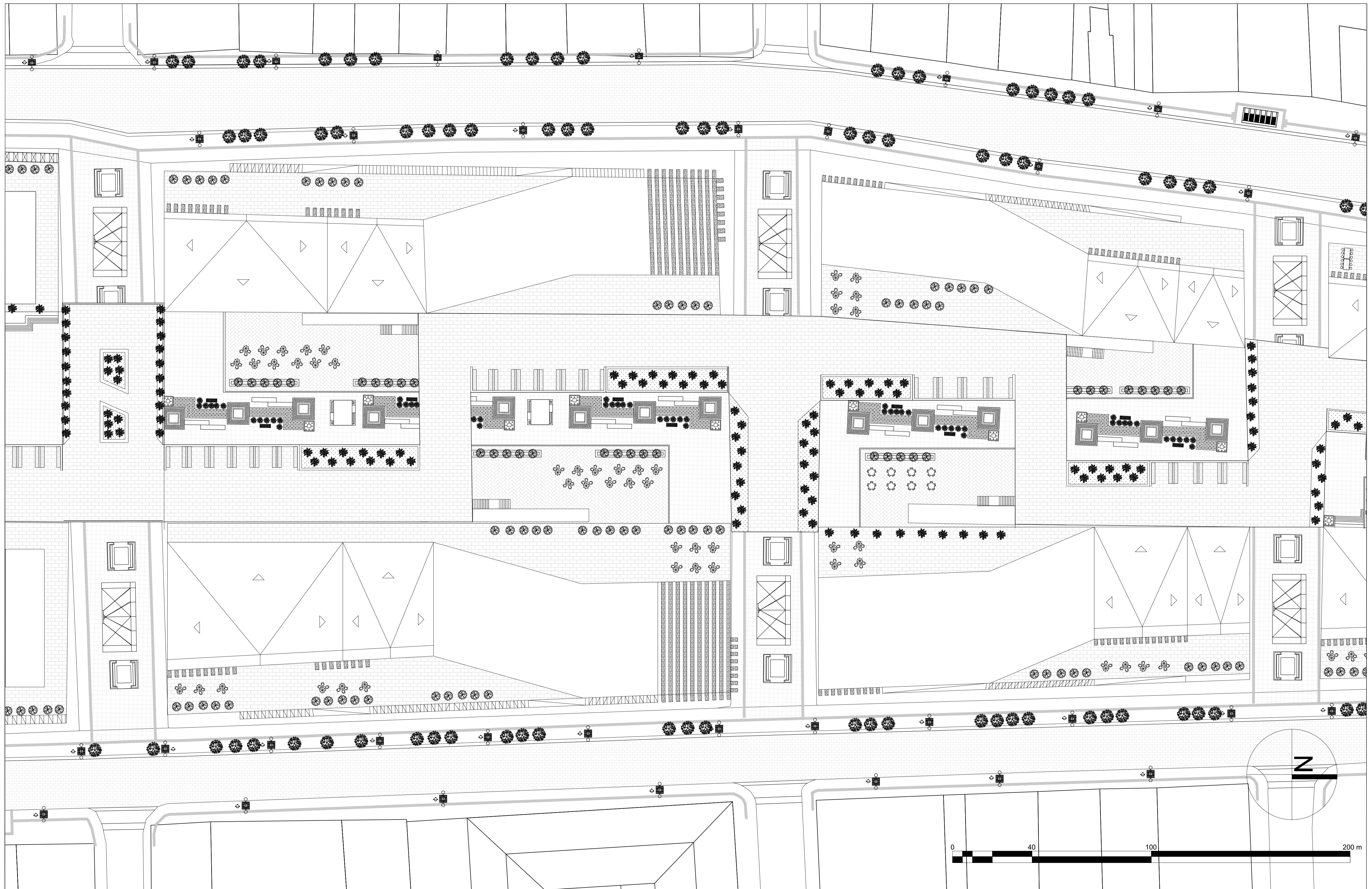

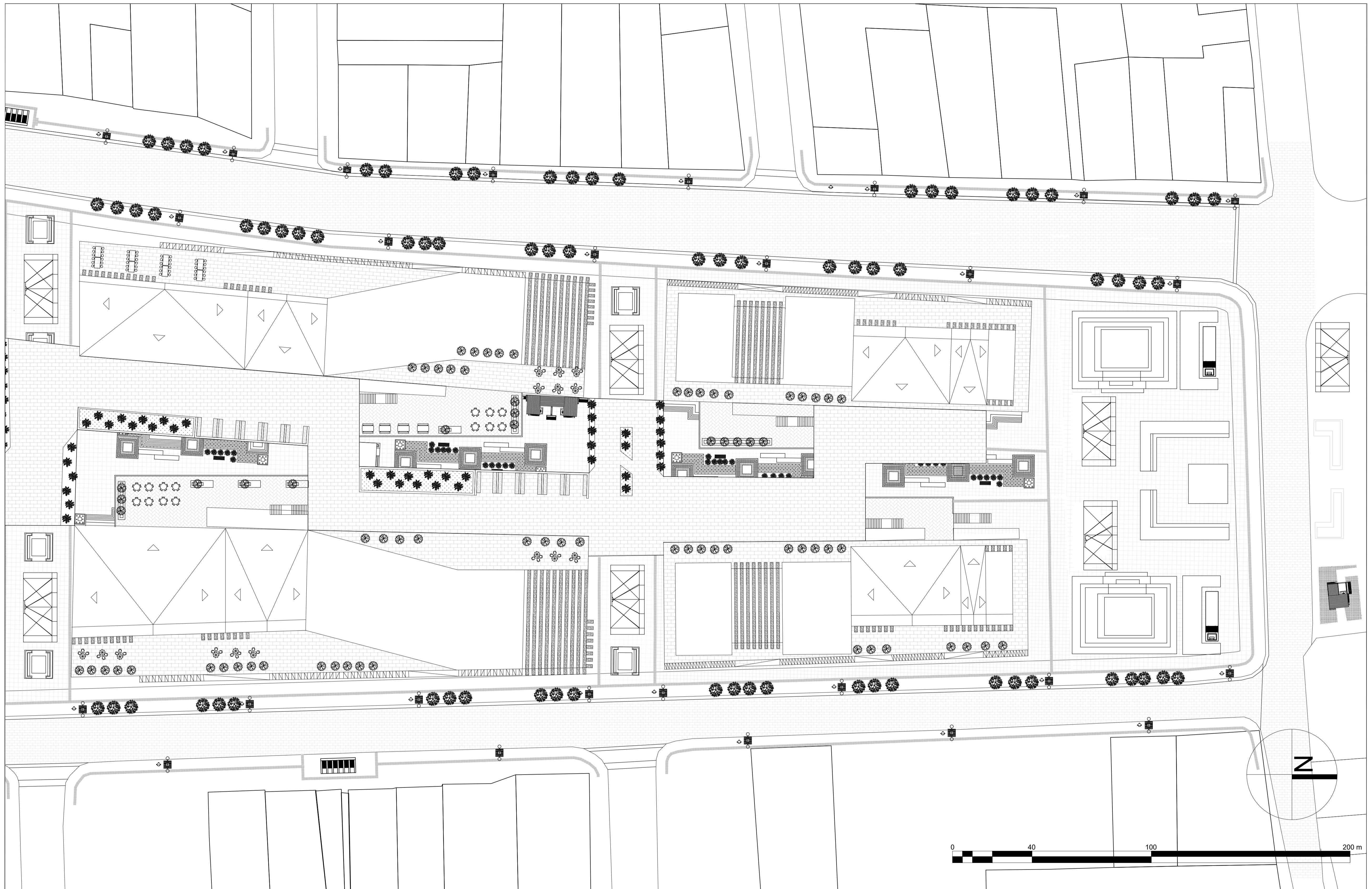

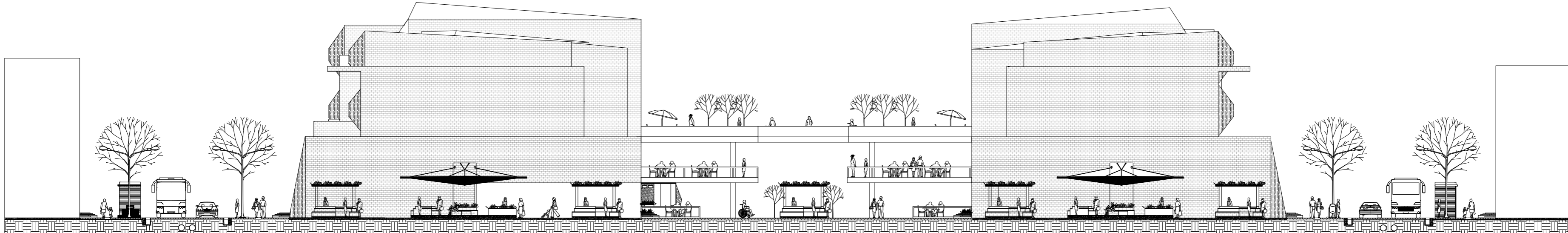

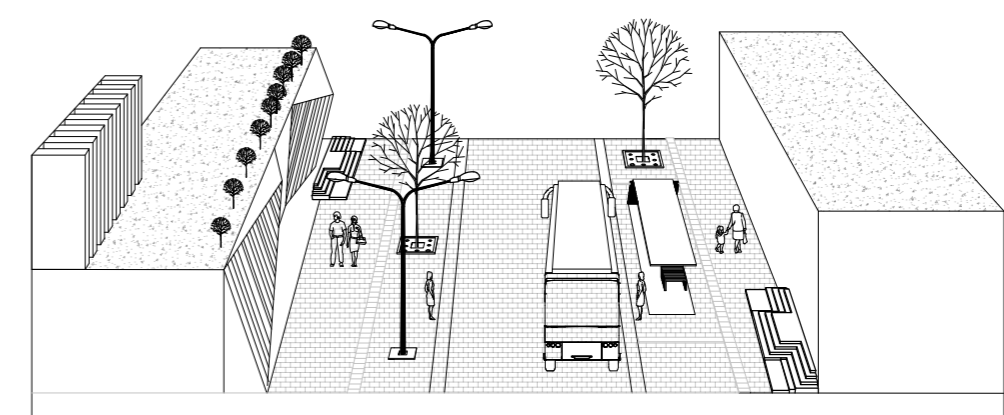
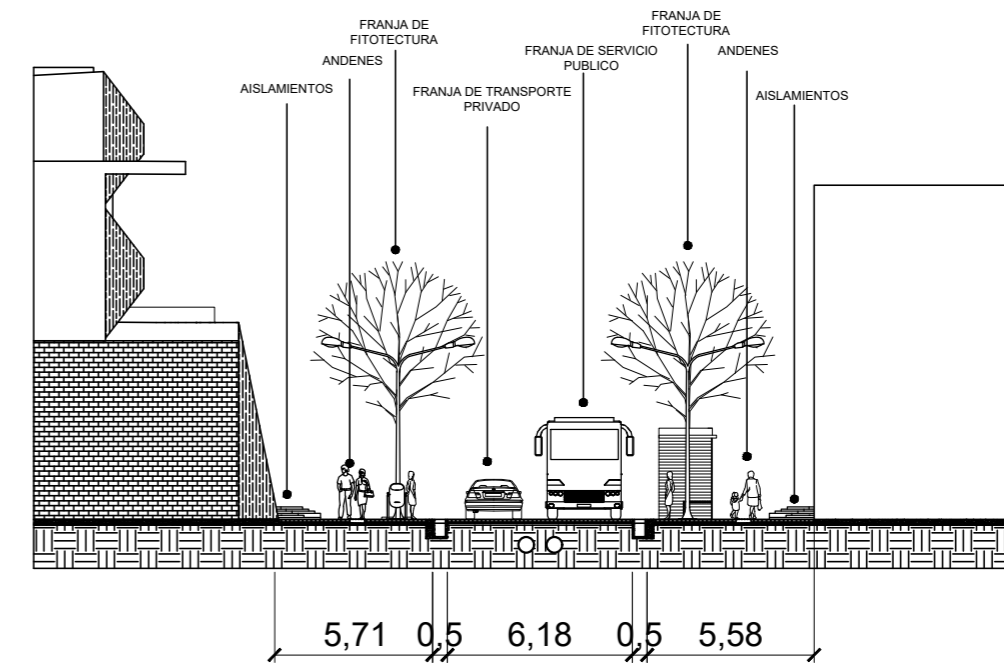
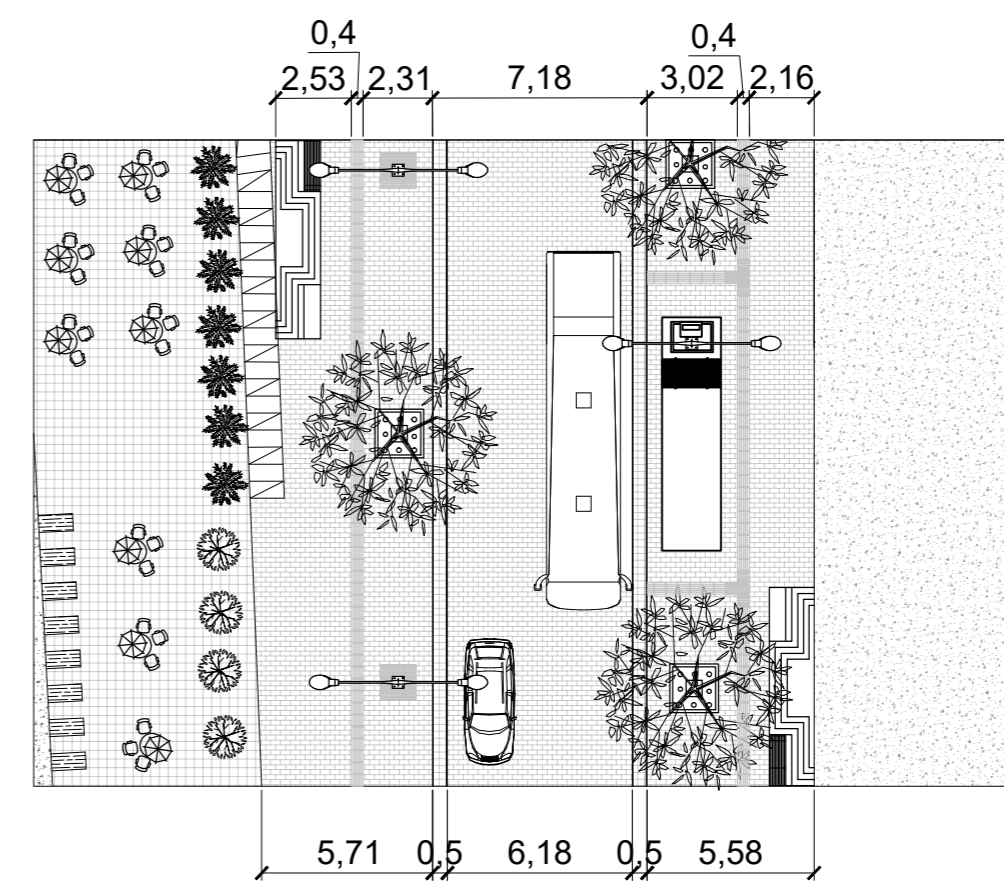
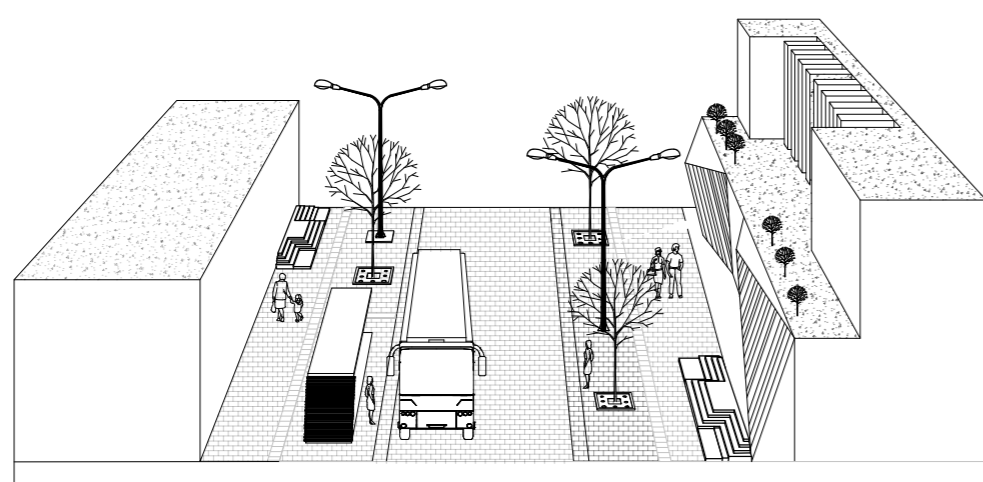
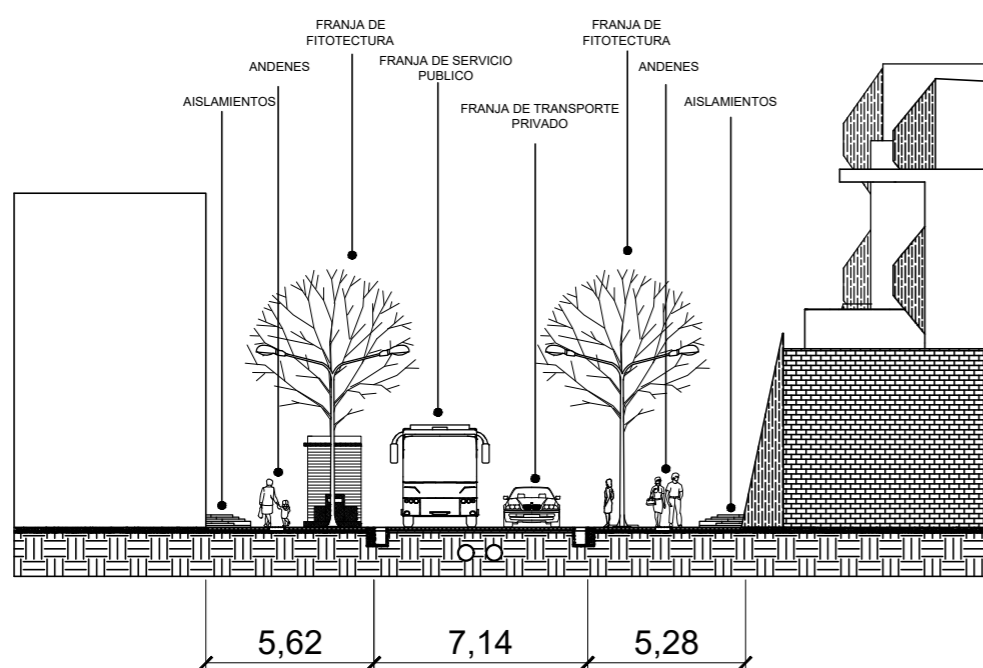
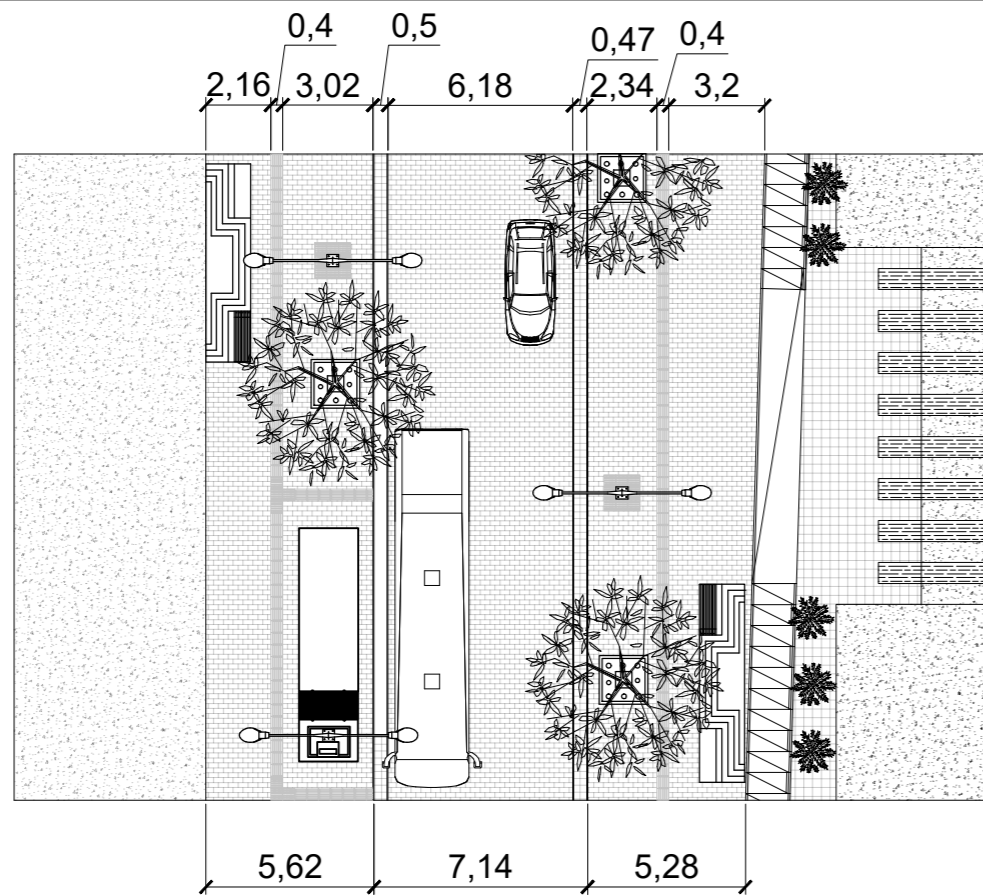

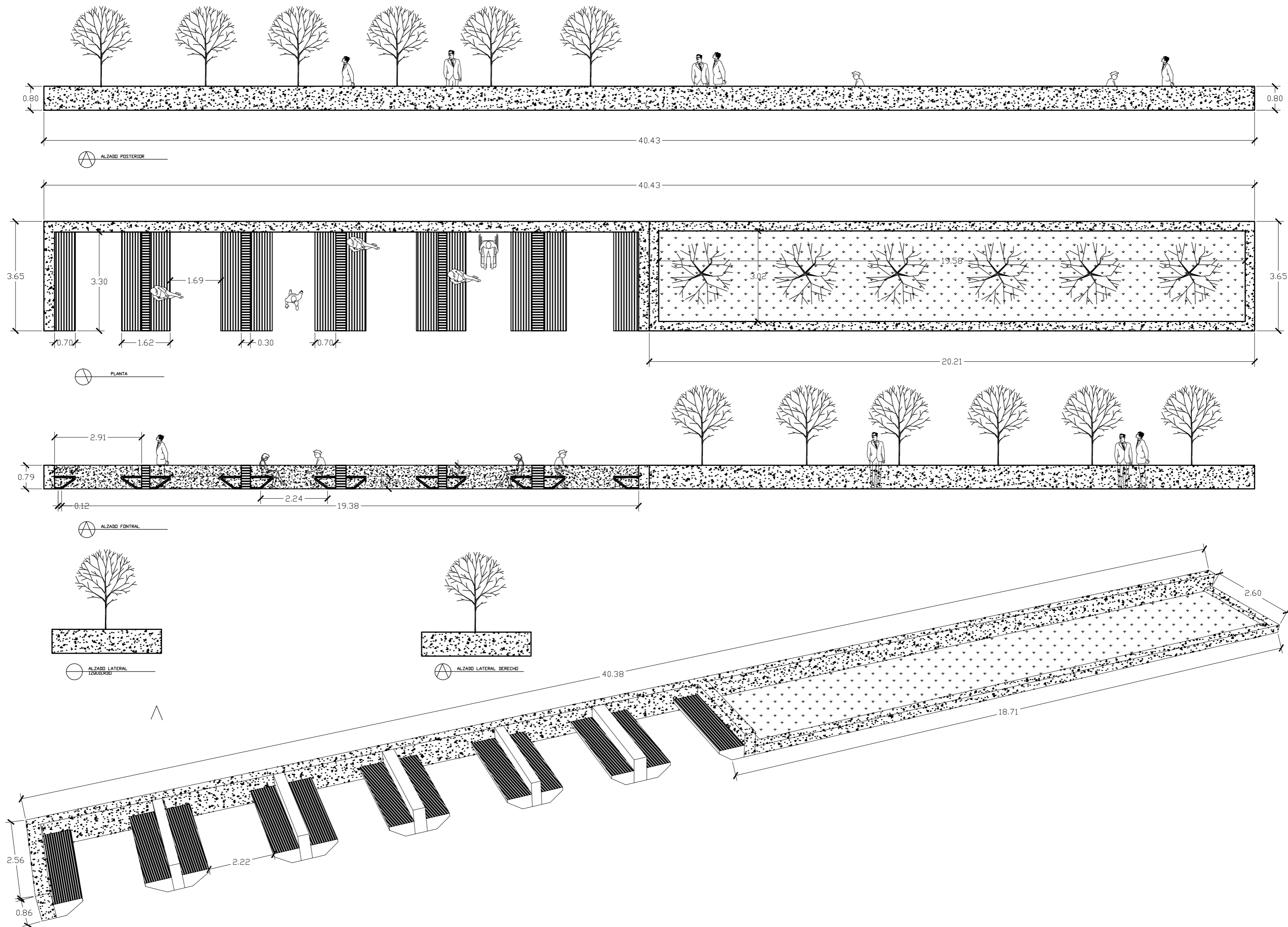

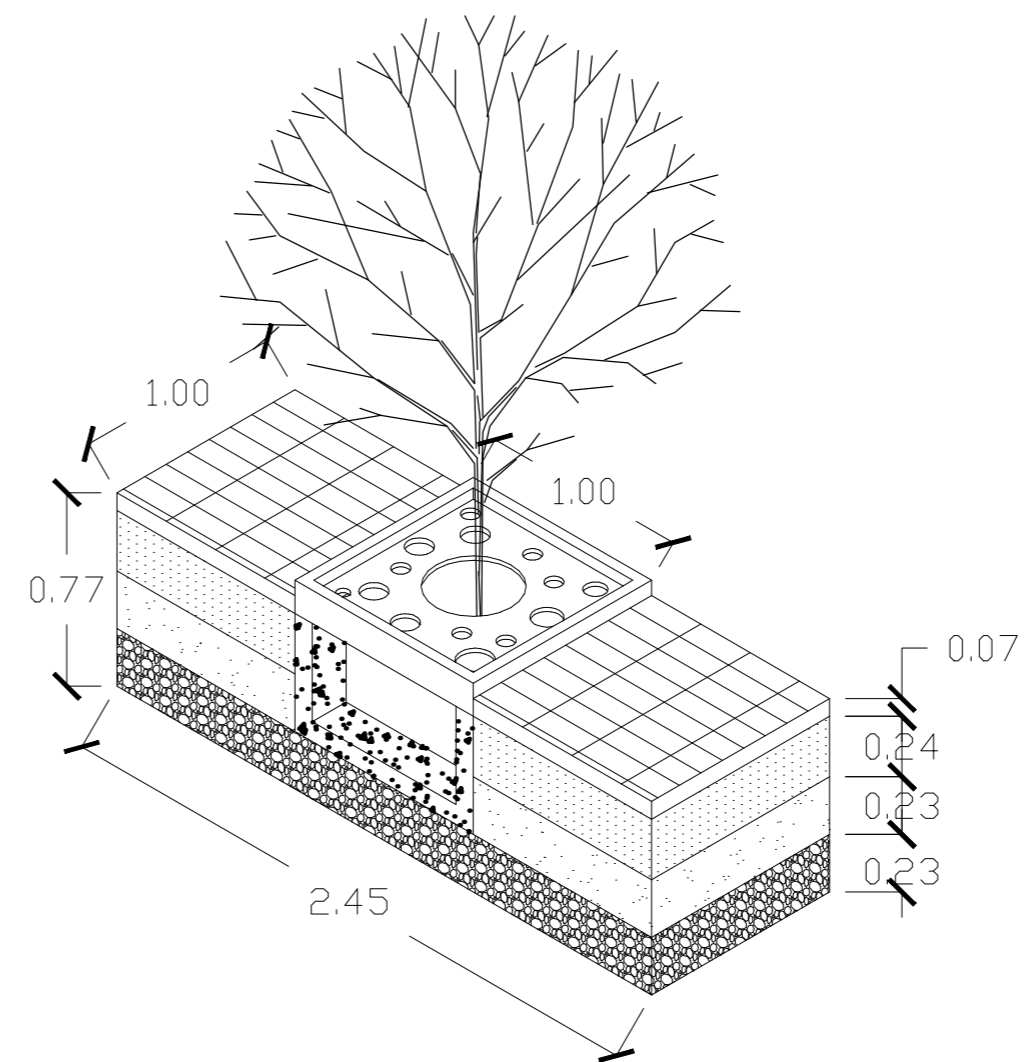
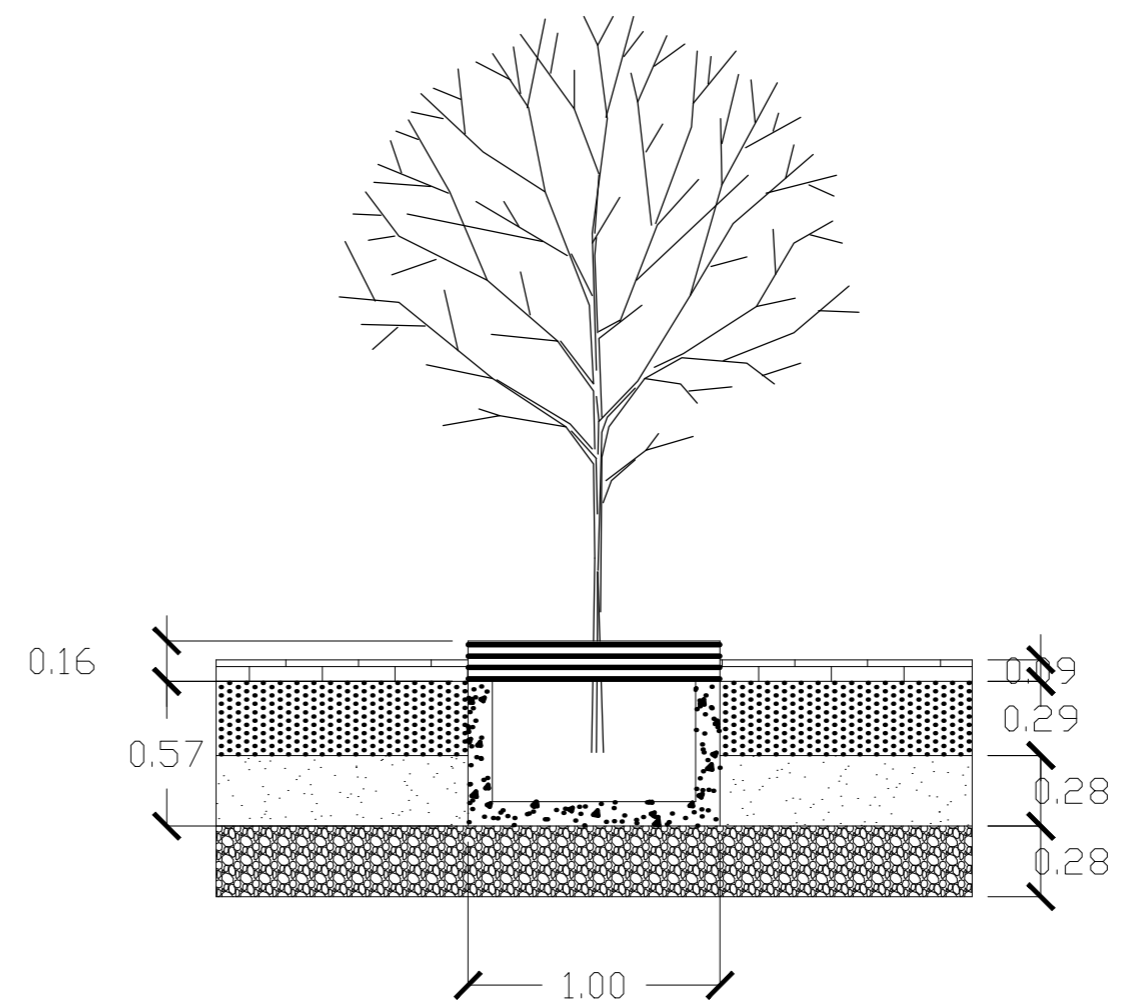
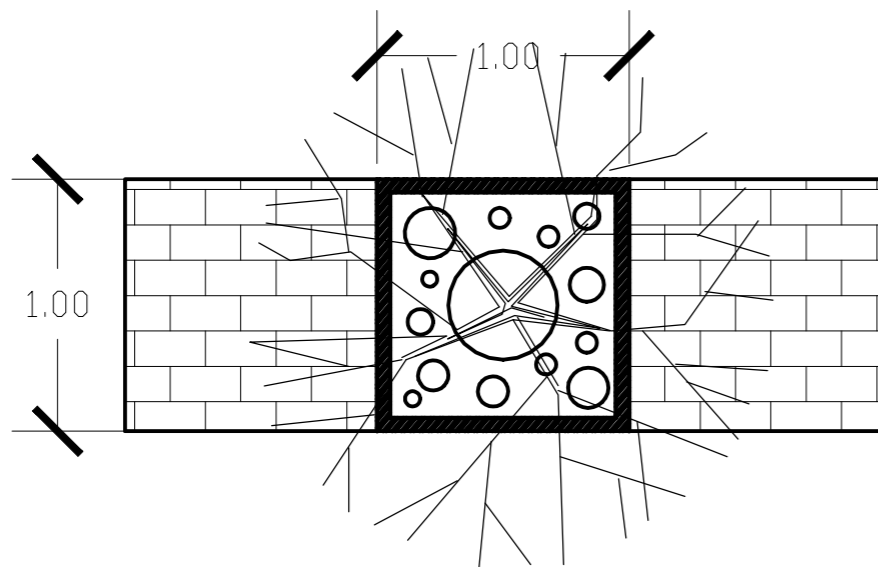

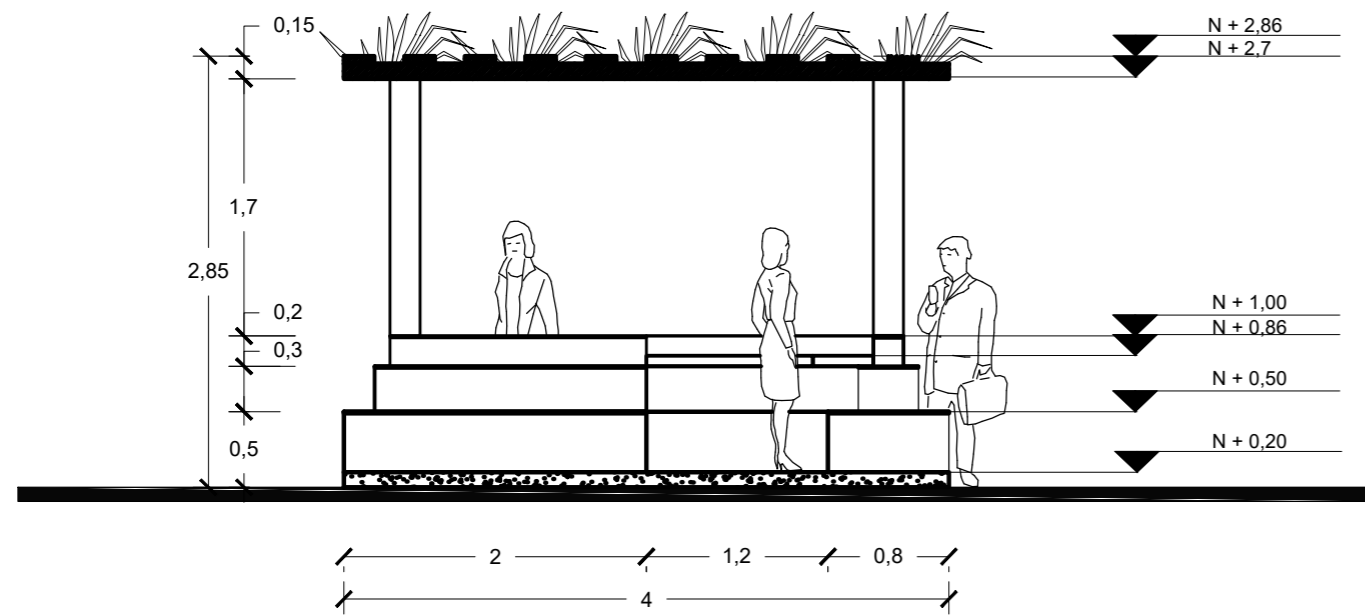

ALZADO FONTRAL

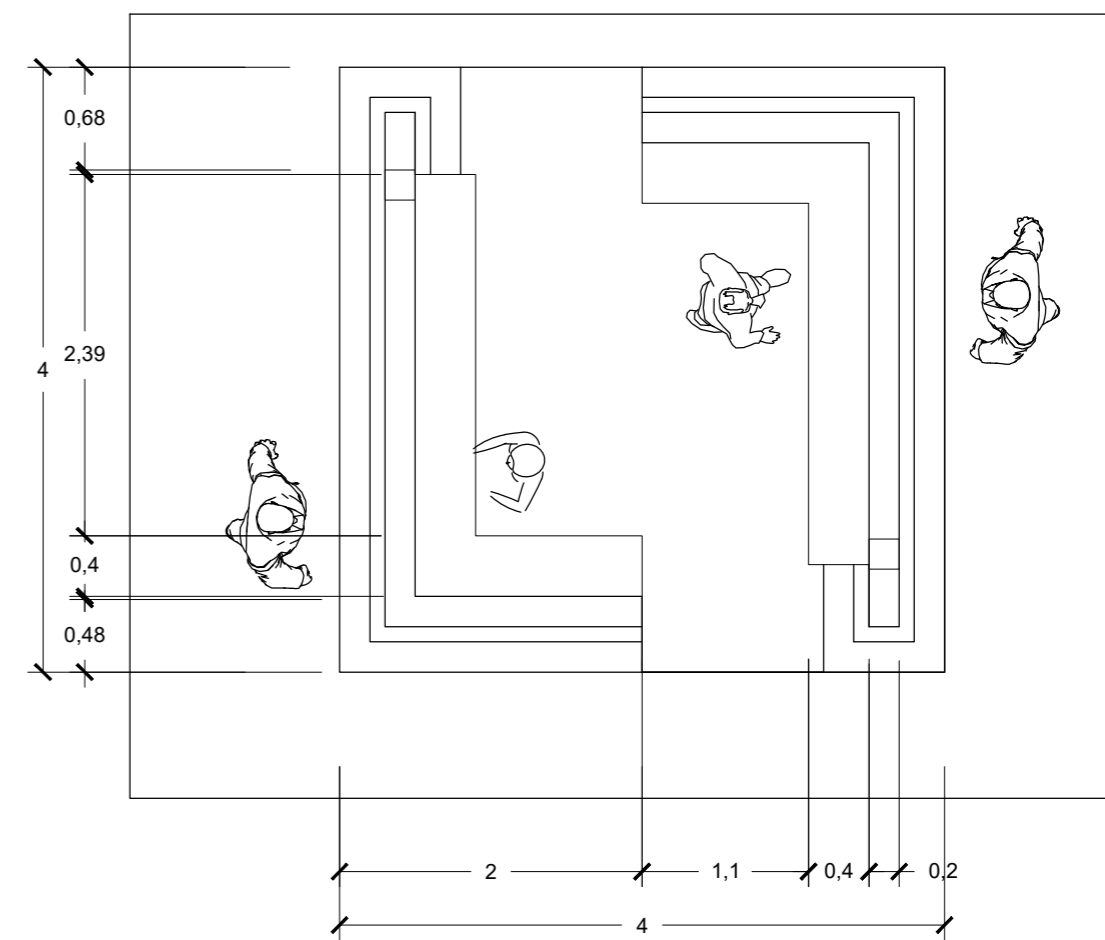

PLANTA

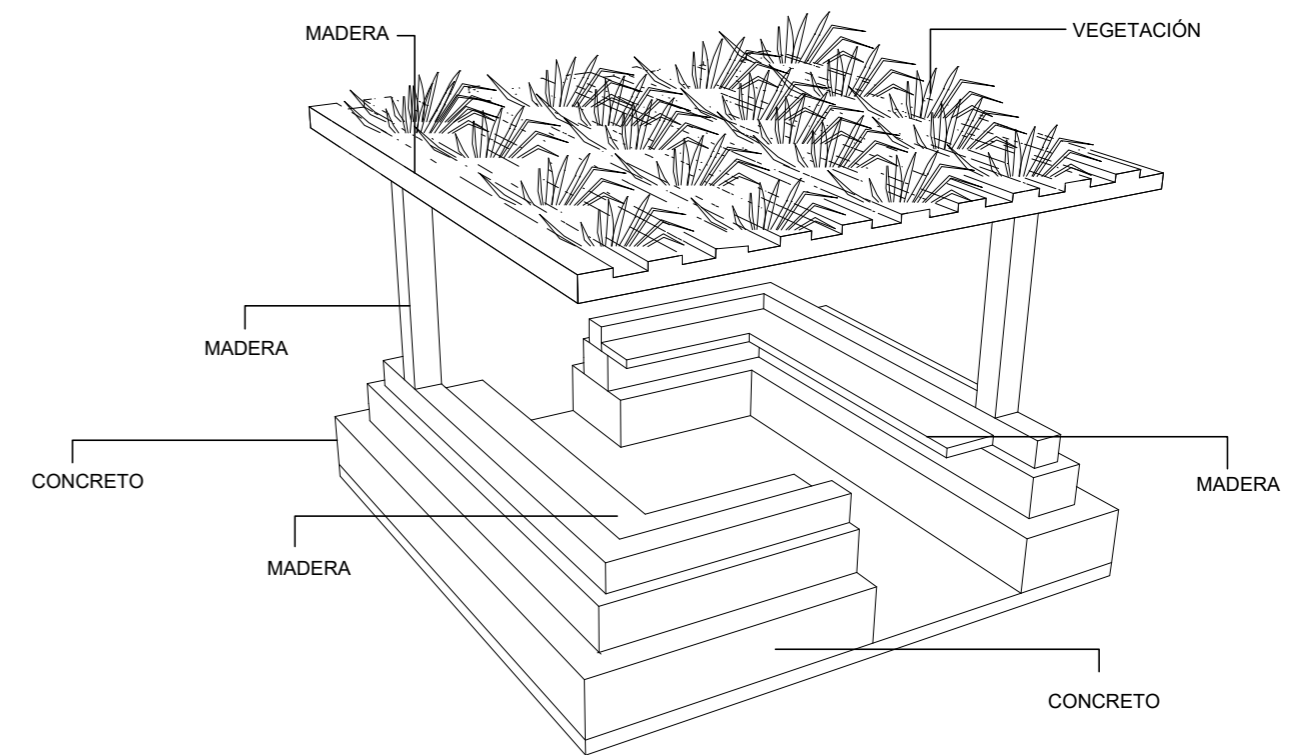
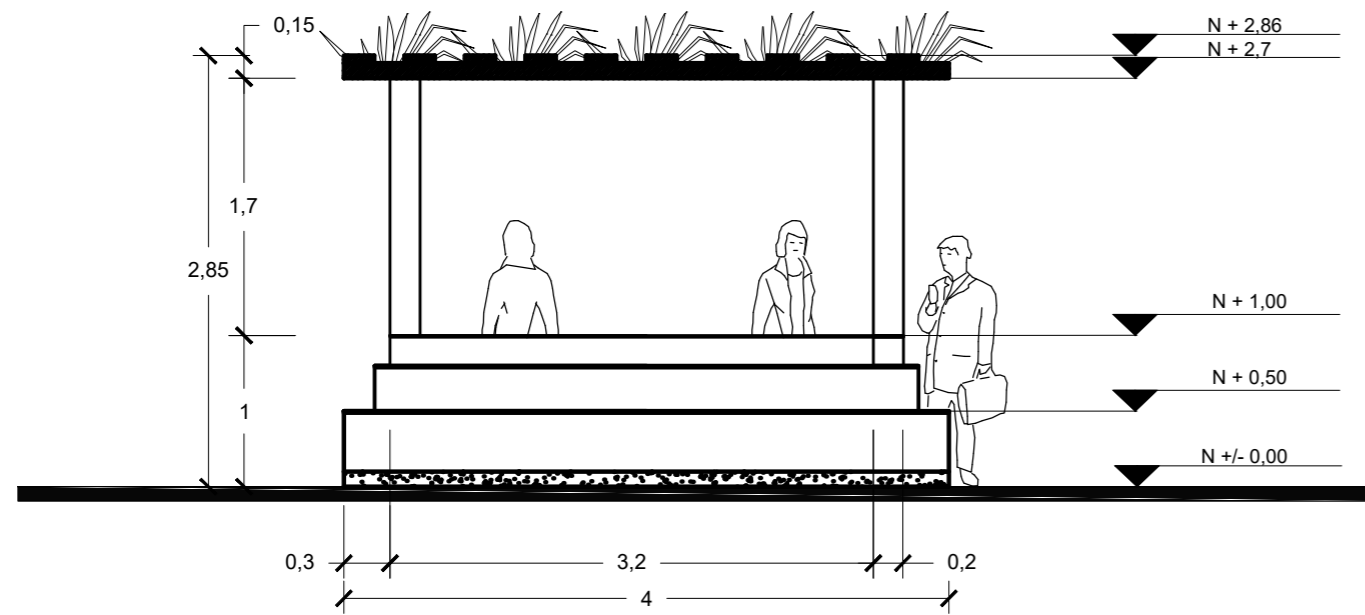

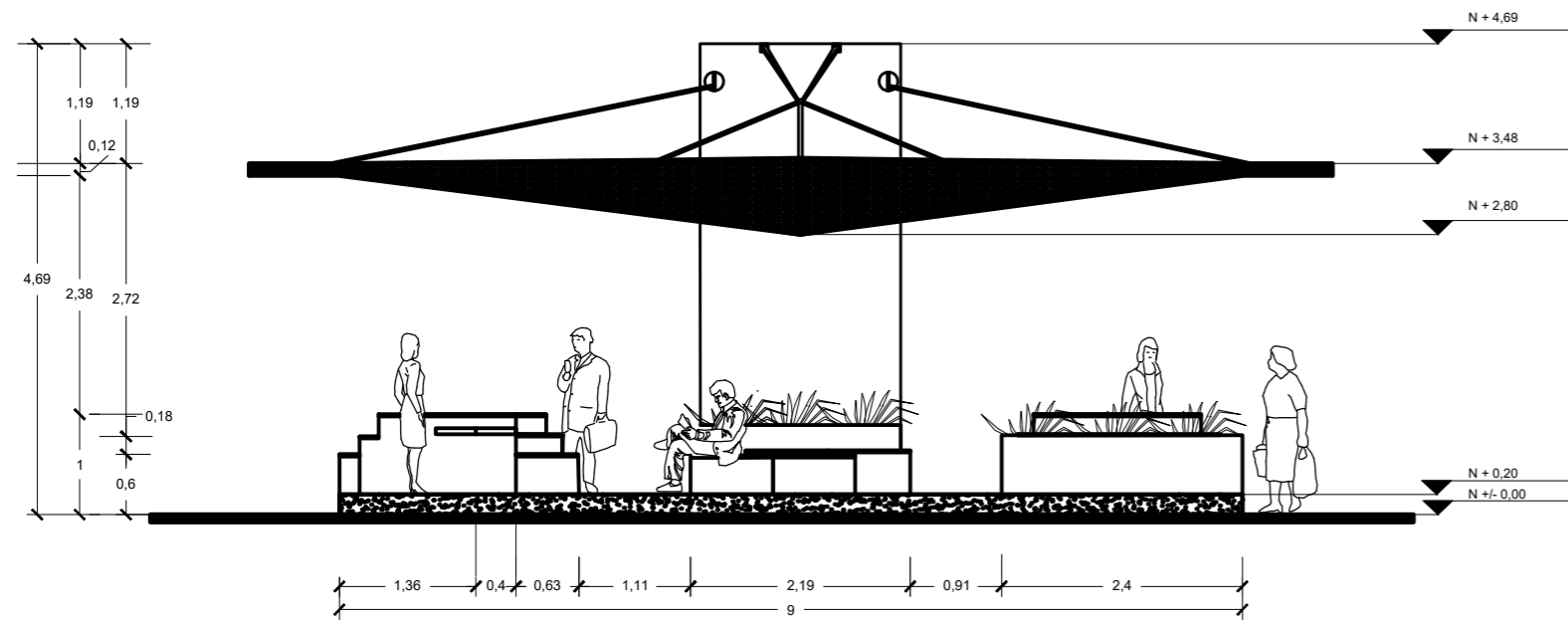

ALZADO FONTRAL

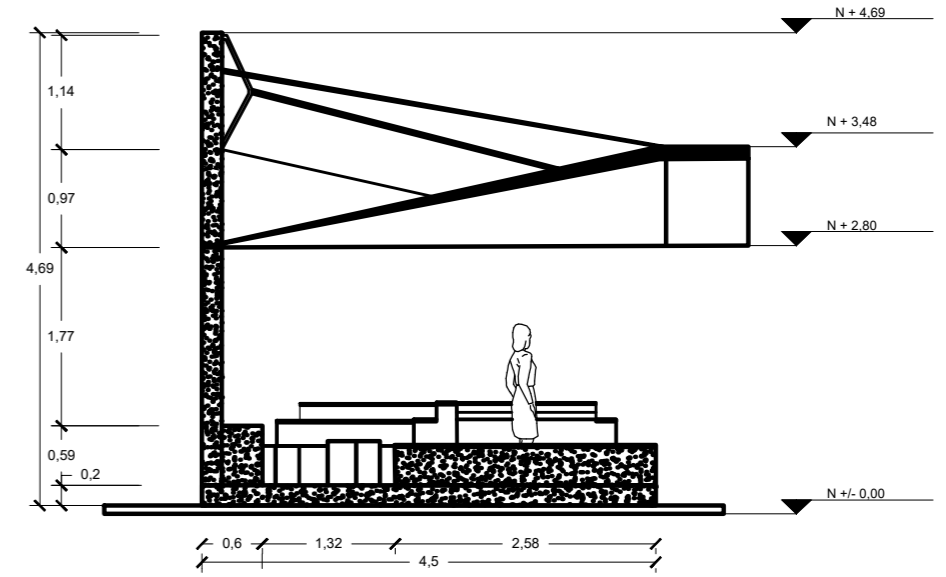

ALZADO LATERAL IZQUIERDO

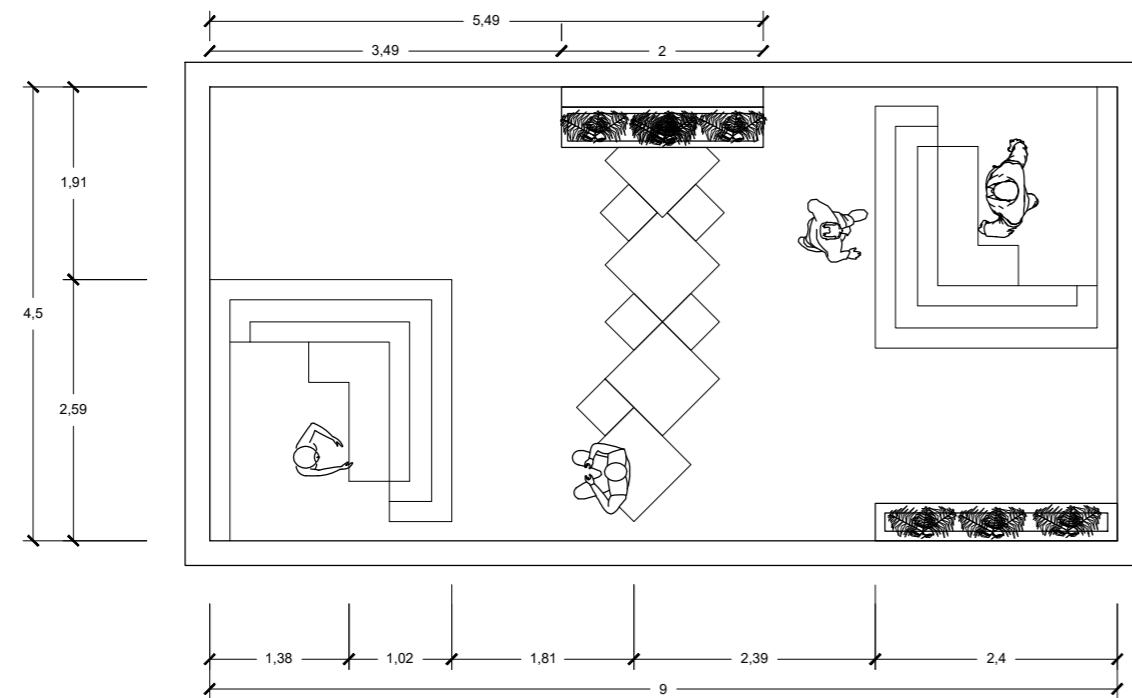

PLANTA

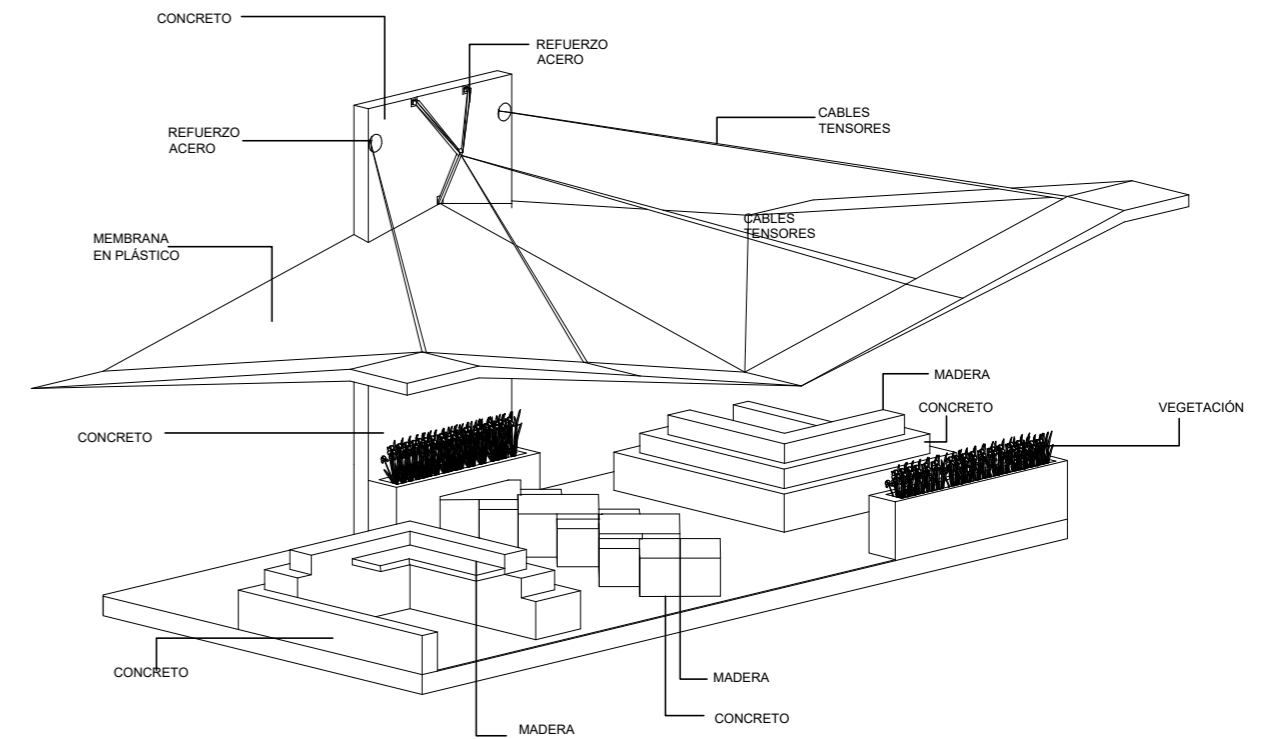

PERSPECTIVA

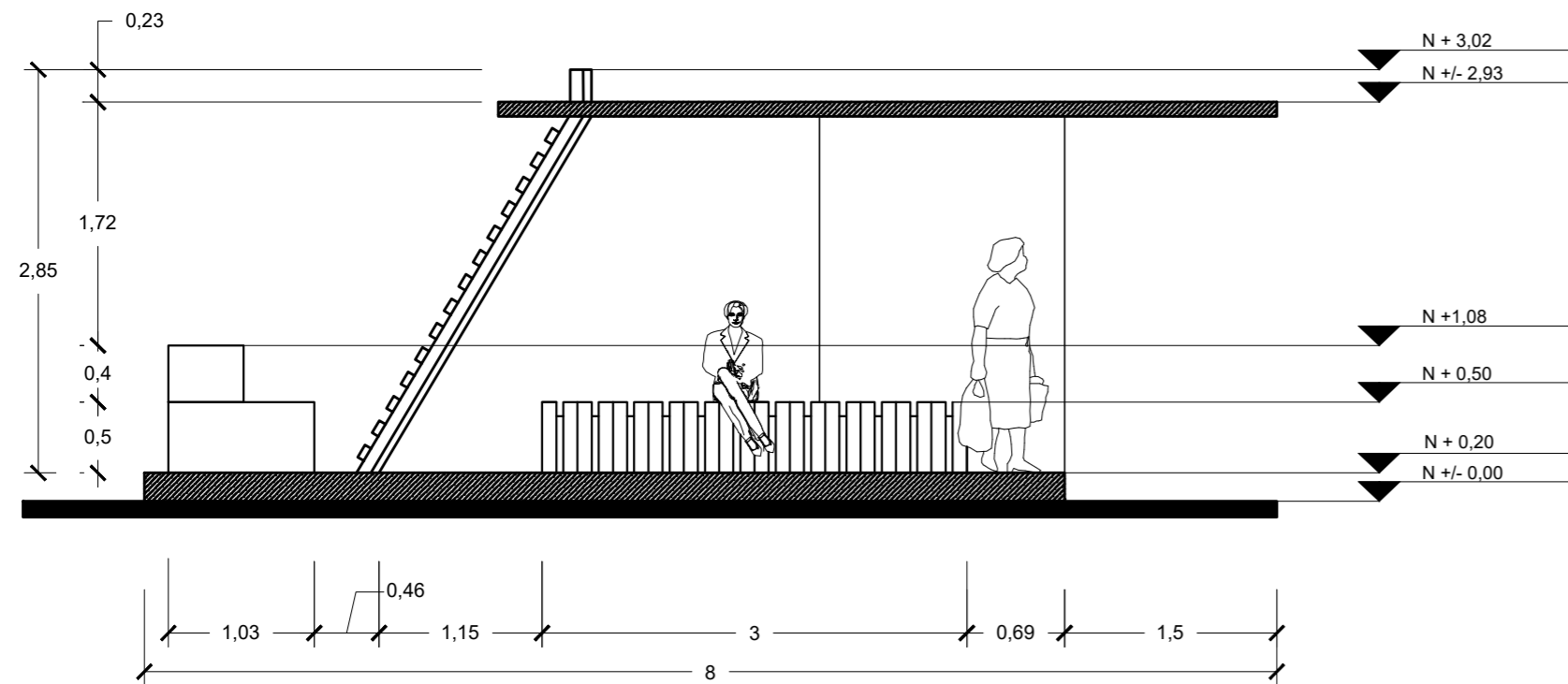

ALZADO FONTRAL

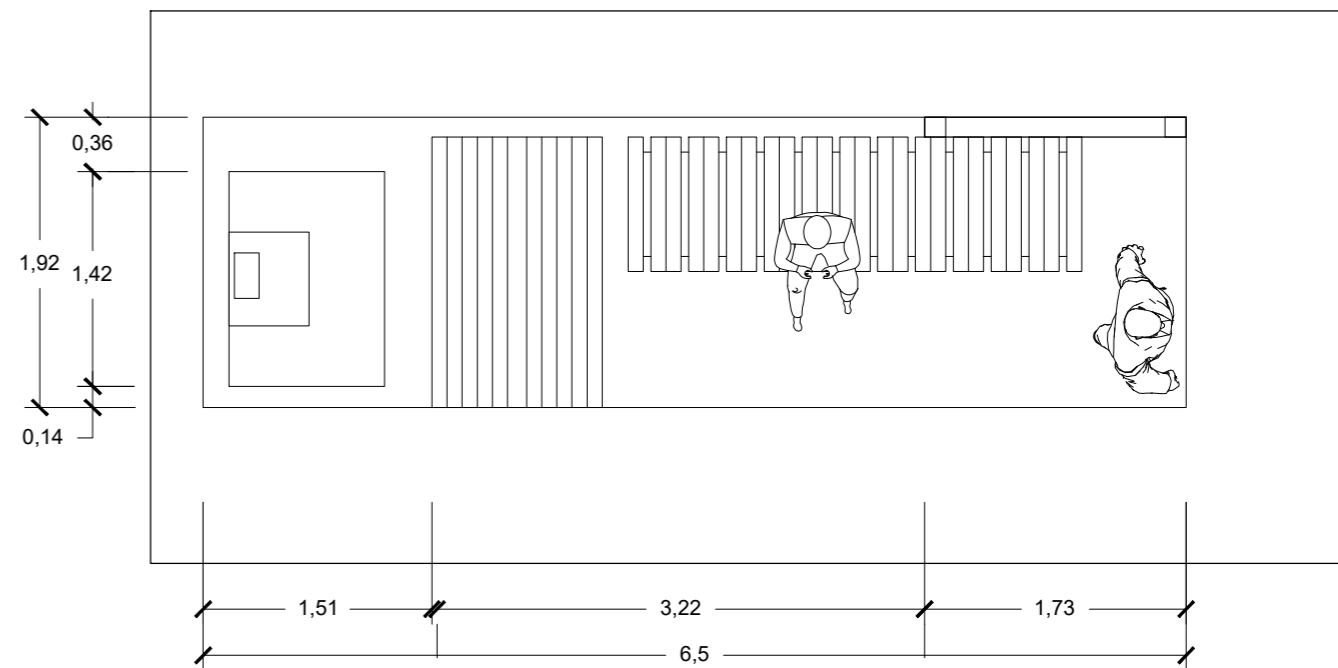

PLANTA

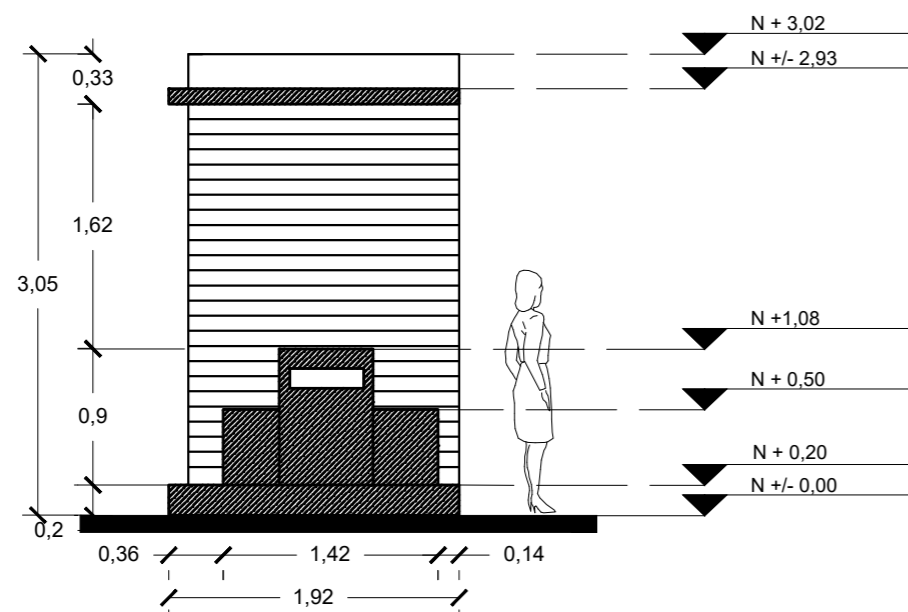

ALZADO LATERAL IZQUIERDO

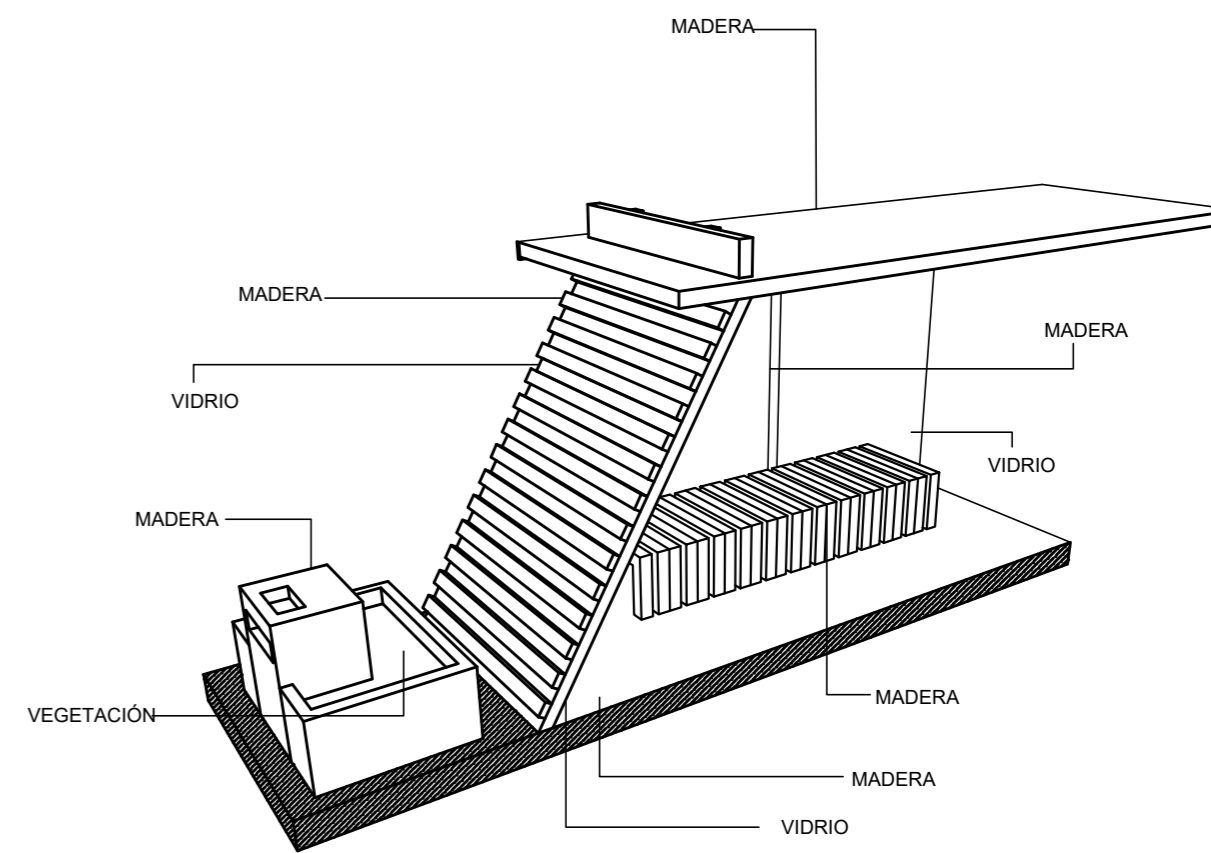

PERSPECTIVA

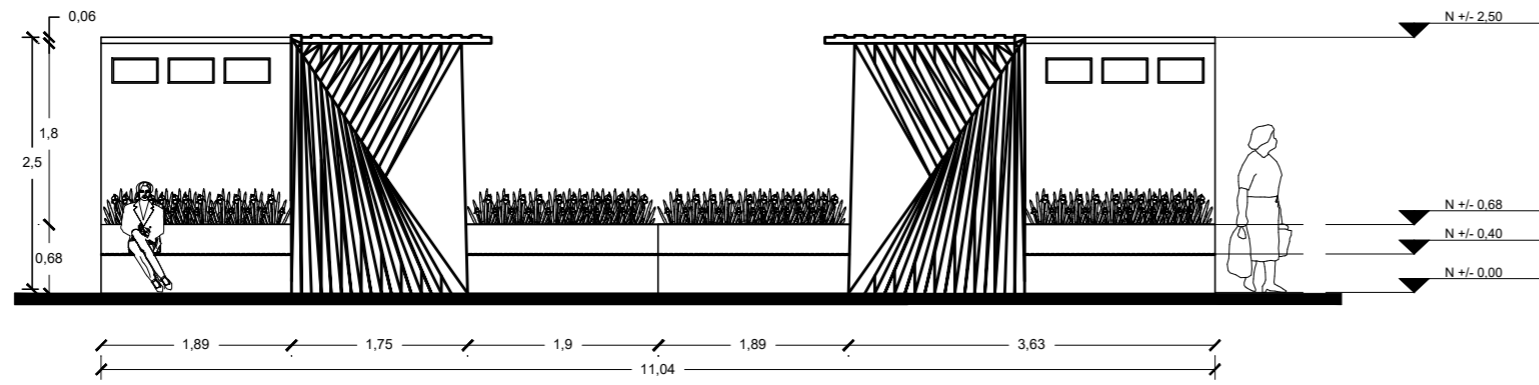

ALZADO FONTRAL TIPOLOGIA 2

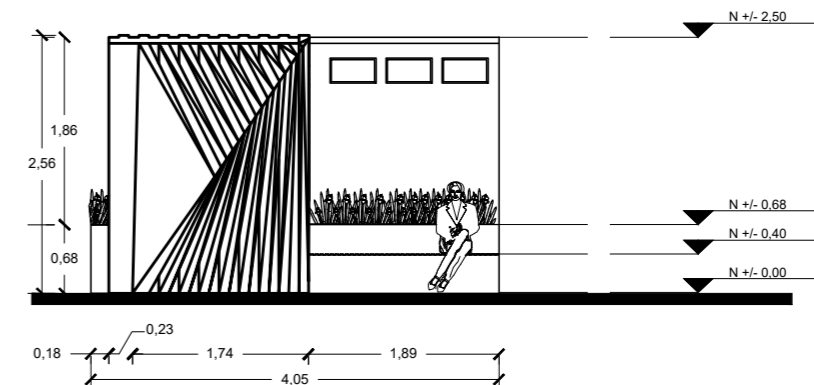

ALZADO FONTRAL TIPOLOGIA 1

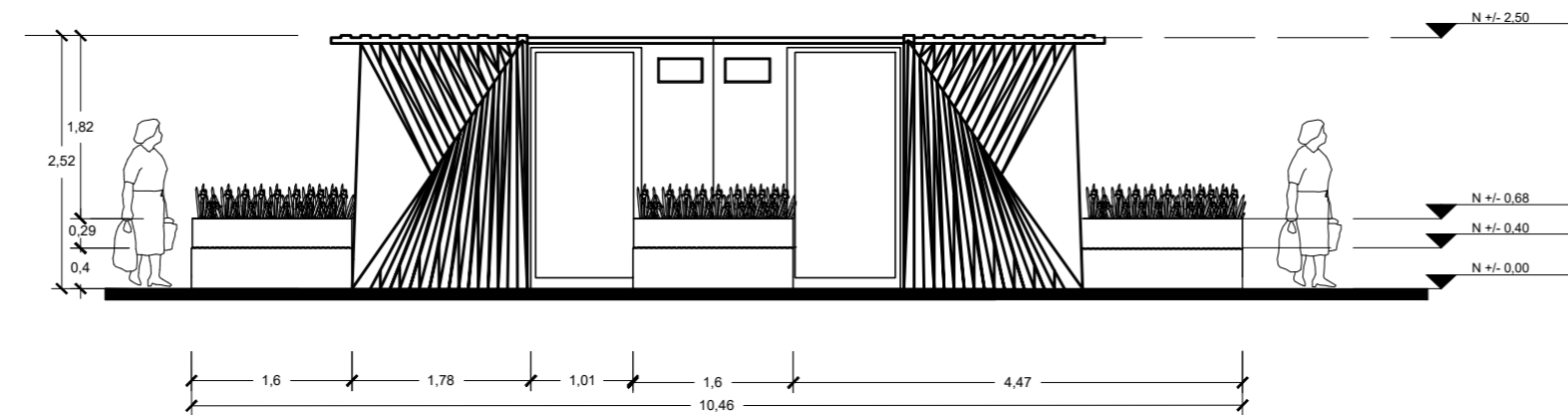

ALZADO FONTRAL TIPOLOGIA 3

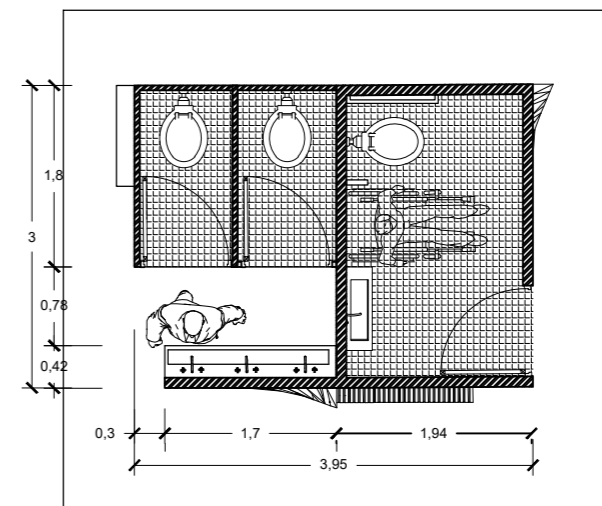

PLANTA GENERAL

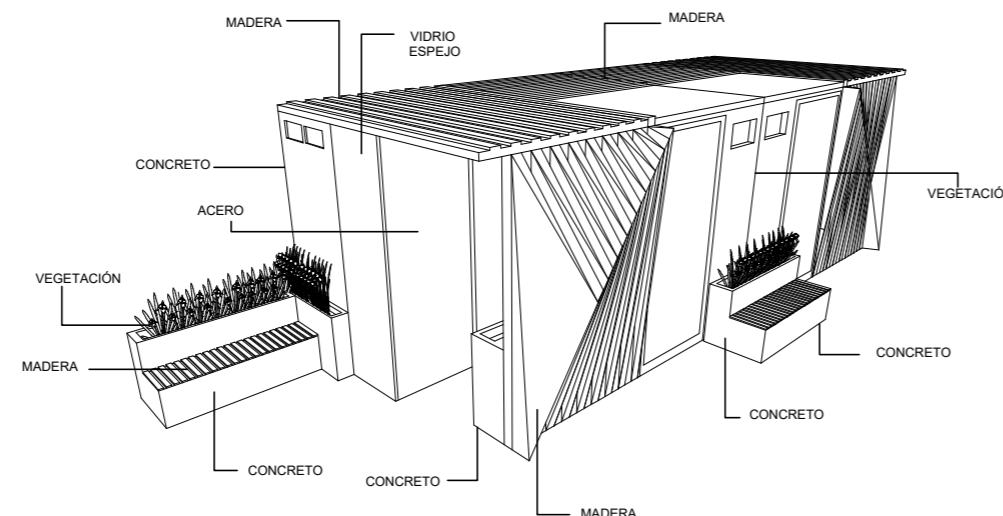

PERSPECTIVA TIPOLOGIA 3

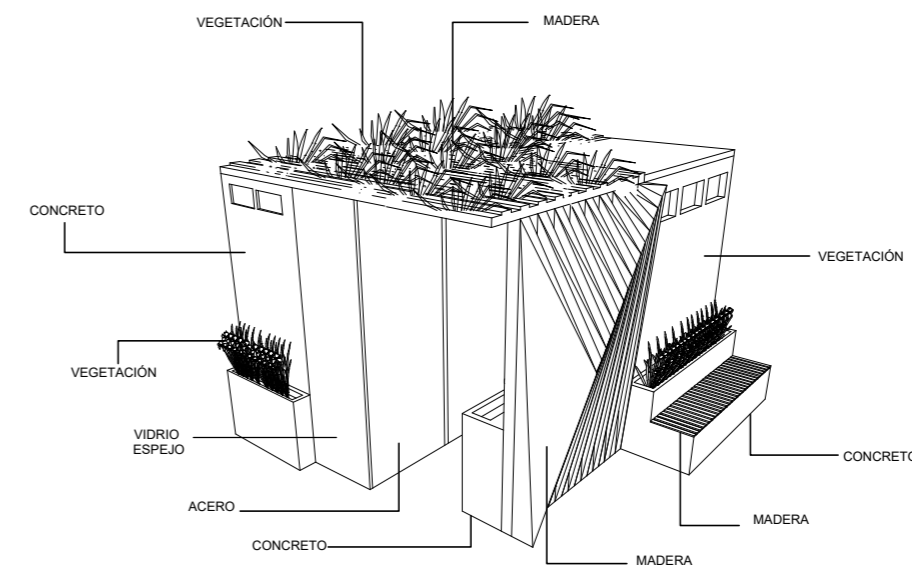

PERSPECTIVA TIPOLOGIA 1

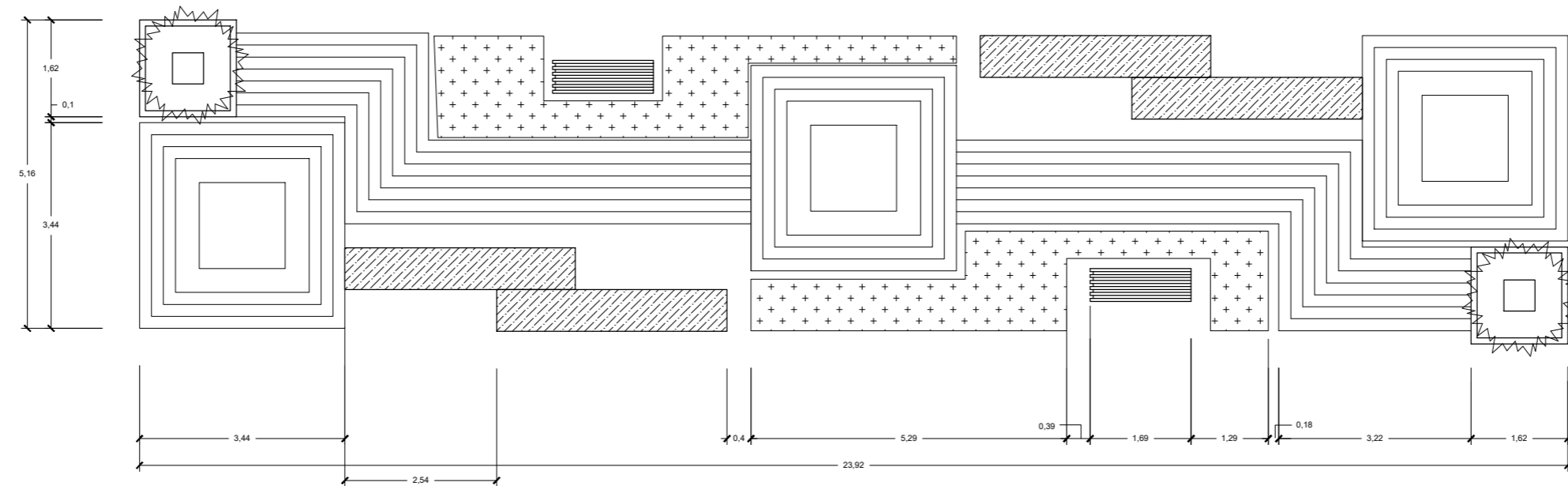

PLANTA GENERAL

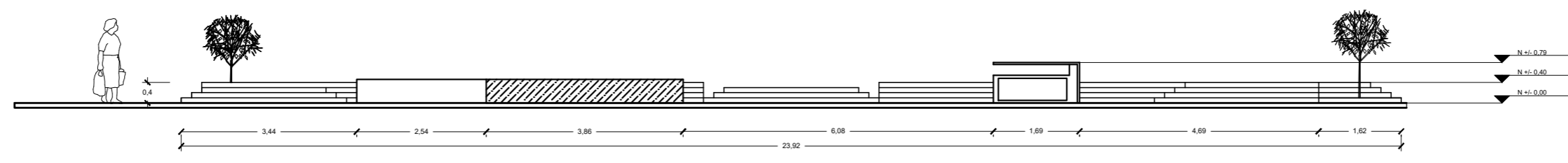

ALZADO FONTRAL

