

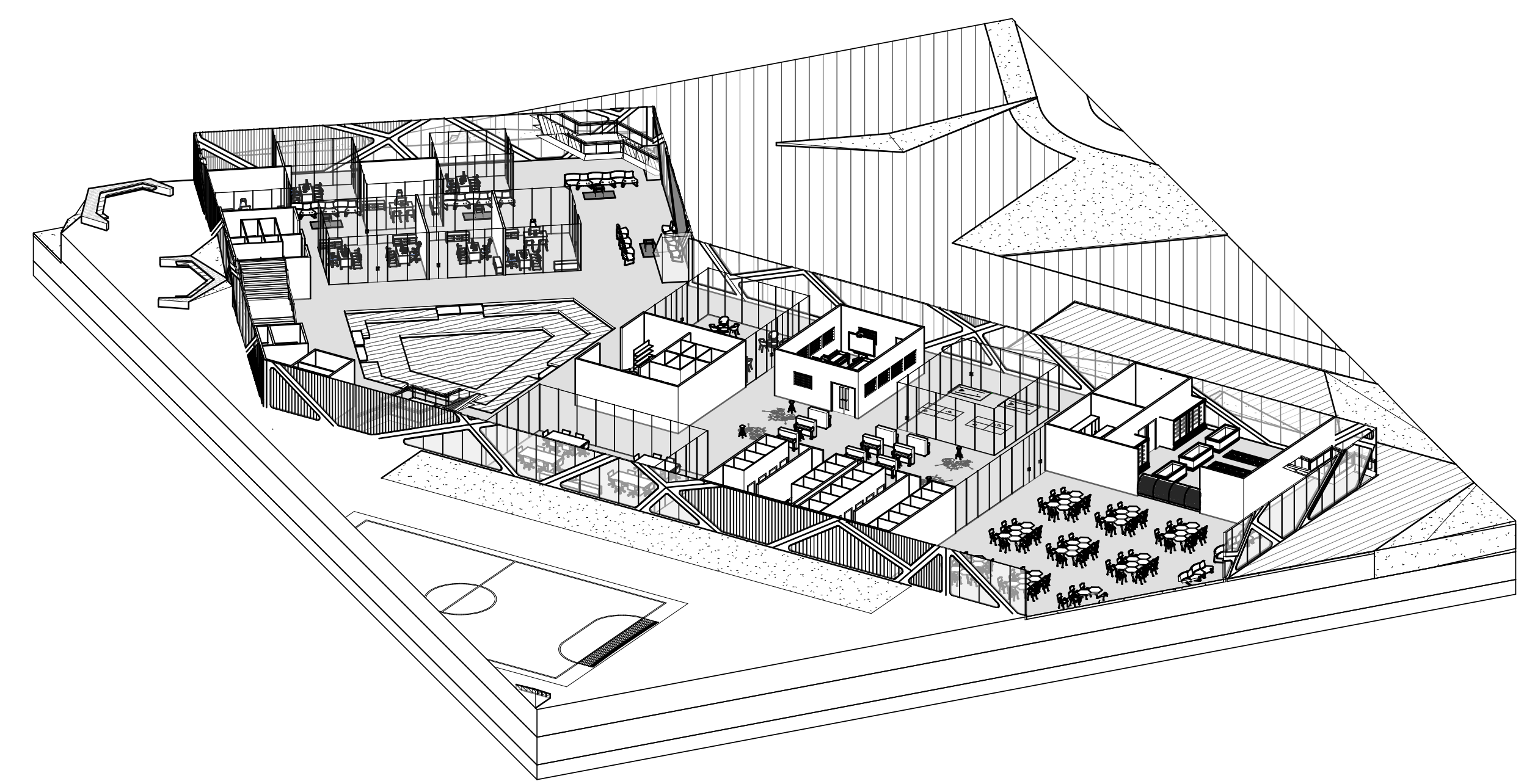

1 NIVEL PISO 2
1 : 150

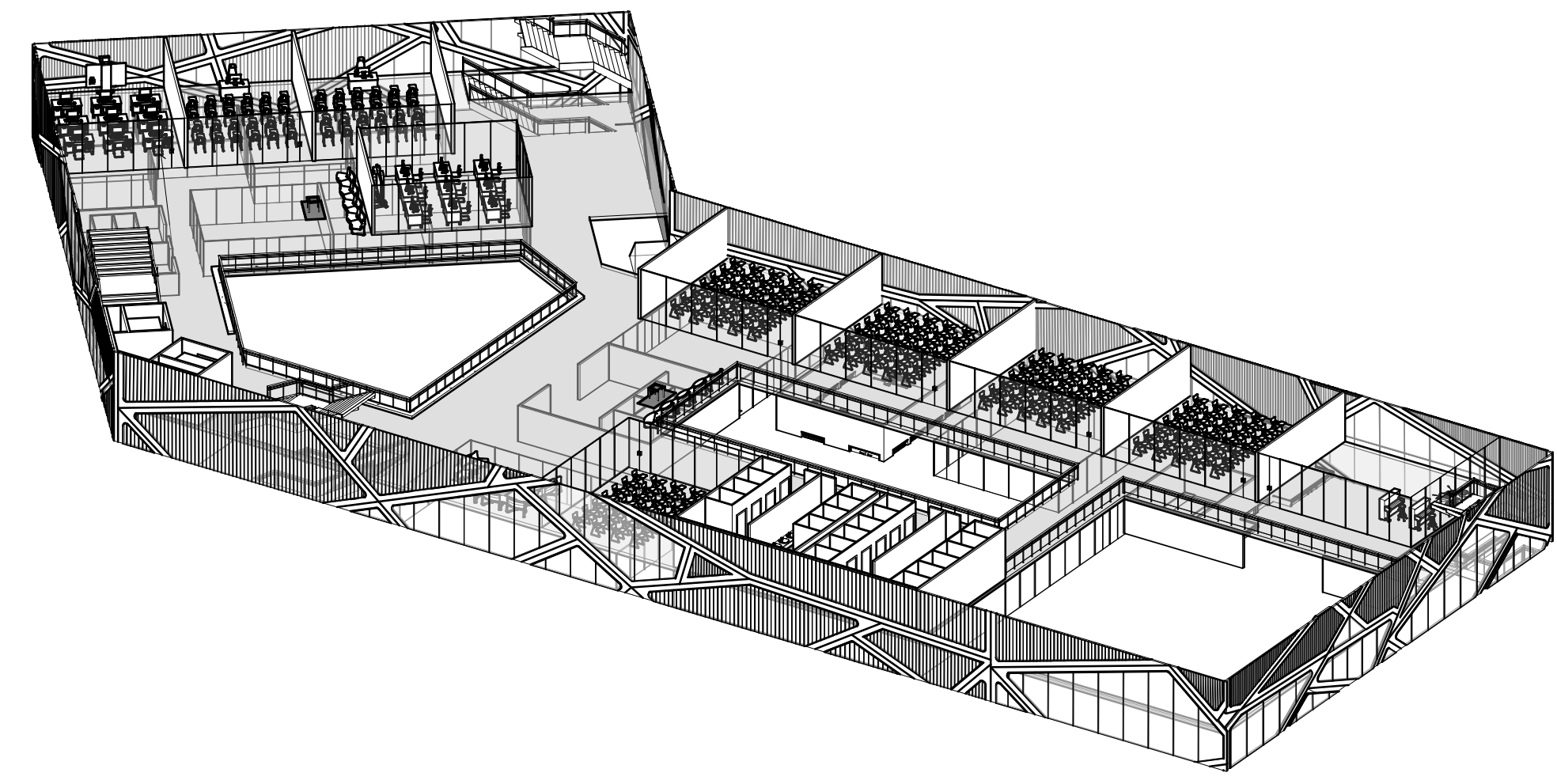

2 ISOMETRICO PLANTA 1



3 ISOMETRICO PLANTA 2

CONTIENE		PLANTA SEGUNDO PISO	
OBSERVACIONES		FECHA INDICADA	
REVISION		11/11/19	
OBSERVACIONES:		ARQ. ALVARO JAVIER BOLAÑOS PALACIOS	
PROFESOR:		ARQ. ALVARO JAVIER BOLAÑOS PALACIOS	
ESTUDIANTE:		NEYER FABIAN OVALLE PINEDA COD. 1.019.080.398	
		DIANA PAOLA PARCO MENDEZ COD. 1.019.080.398	
PROYECTO		CENTRO DE EDUCACIÓN TECNOLÓGICA MONGUI - BOYACA	
UNIVERSIDAD		La Gran Colombia	
REVISION		A102	

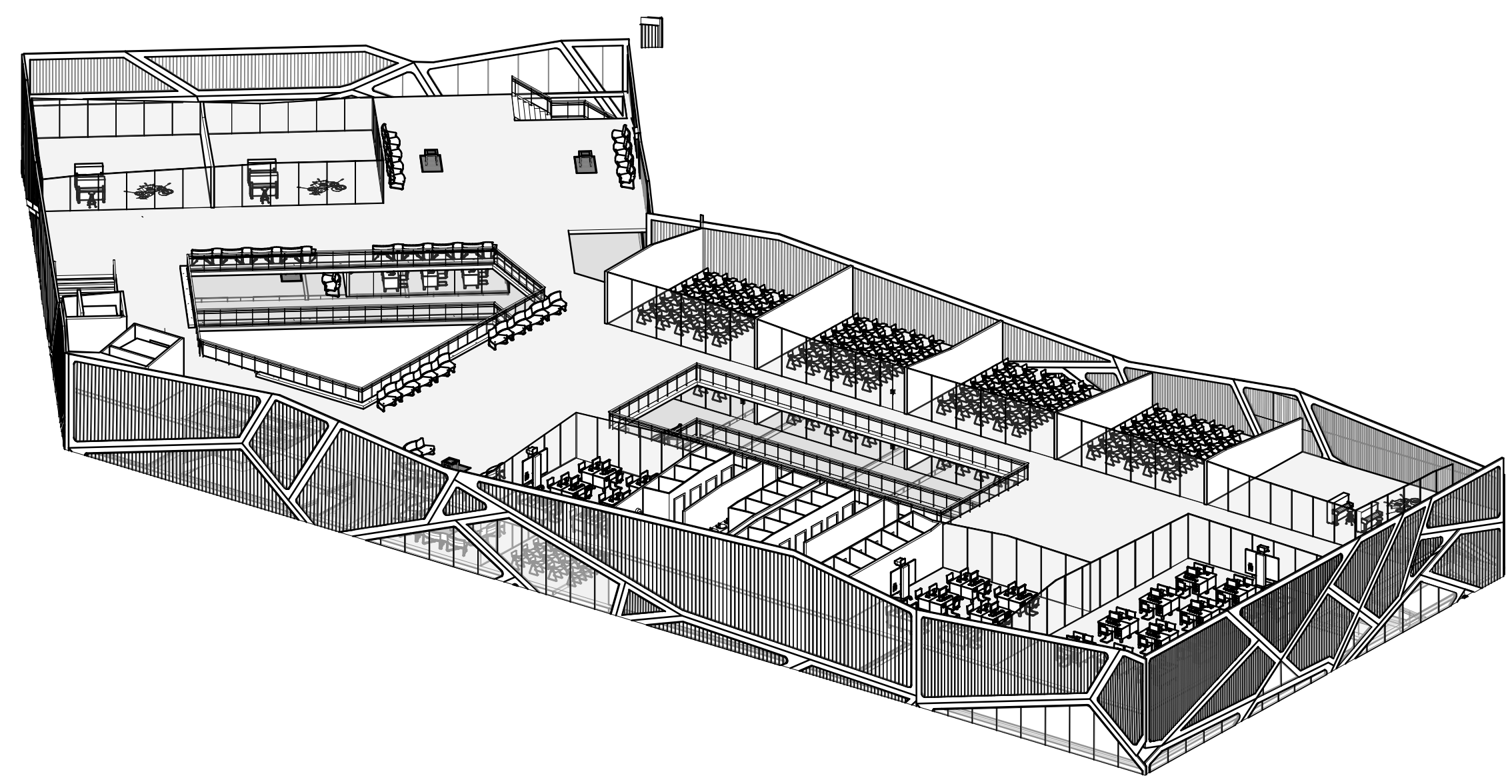
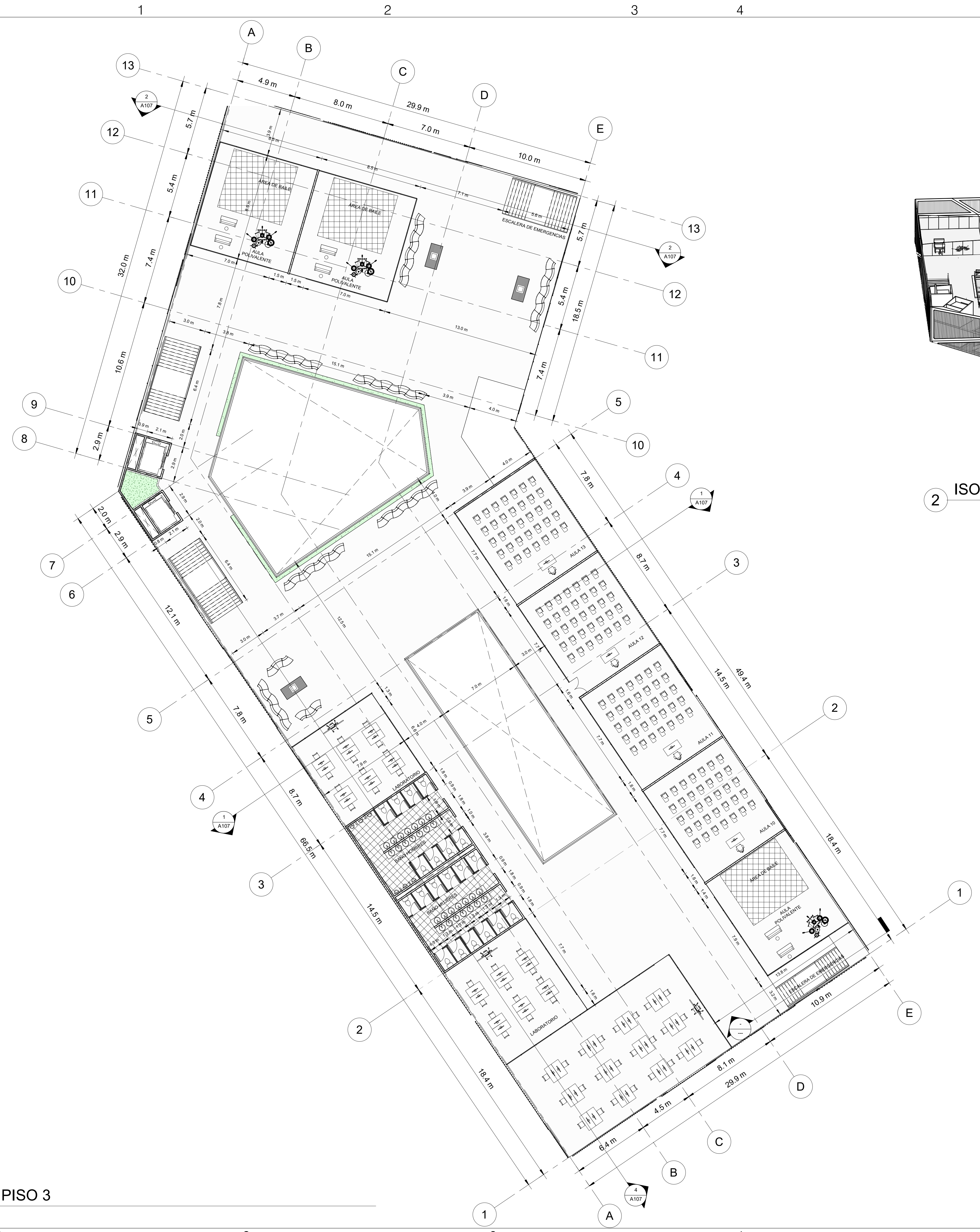
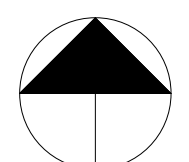

2 ISOMETRICO PLANTA 3

1 NIVEL PISO 3
1 : 150

PROYECTO	CENTRO DE EDUCACIÓN TECNOLÓGICA MONGUI - BOYACA
ESTUDIANTES:	NETER FABIAN OVALLE PINEDA COD. 1.019.080.398 DIANA PAOLA PARCO MENDEZ COD. 1.019.080.398
PROFESOR:	ARQ. ALVARO JAVIER BOLAÑOS PALACIOS
OBSERVACIONES:	
REVISIÓN	
OBSERVACIONES:	
CONTIENE	PLANTA TERCER PISO
ESCALA INDICADA	FECHA 11/13/19
PLANCHAS No.	001
NO. DE PLANOS	001V
NO. DE PLANOS	NO. DE PLANOS



1 NIVEL CUBIERTA
BIBLIOTECA Y ADITORIO
1 : 100

CONTIENE		901 V	
PLANTA CUBIERTA BIBLIOTECA Y AUDITORIO		ESCALA	FECHA
OBSERVACIONES		INDICADA	09/12/19
REVISION			
OBSERVACIONES:			
PROFESOR:		ARQ. ALVARO JAVIER BOLAÑOS PALACIOS	
ESTUDIANTES:		NEVER FABIAN OVALLE PINEDA COD. 1.019.080.398 DIANA PAOLA PARCO MENDEZ COD. 1.019.080.398	
PROYECTO		CENTRO DE EDUCACIÓN TECNOLÓGICA MONSEJÚ - BOYACÁ	
UNIVERSIDAD		La Gran Colombia	
REVISION	PLANCHAS	FECHA	
A106	02	09/12/19	

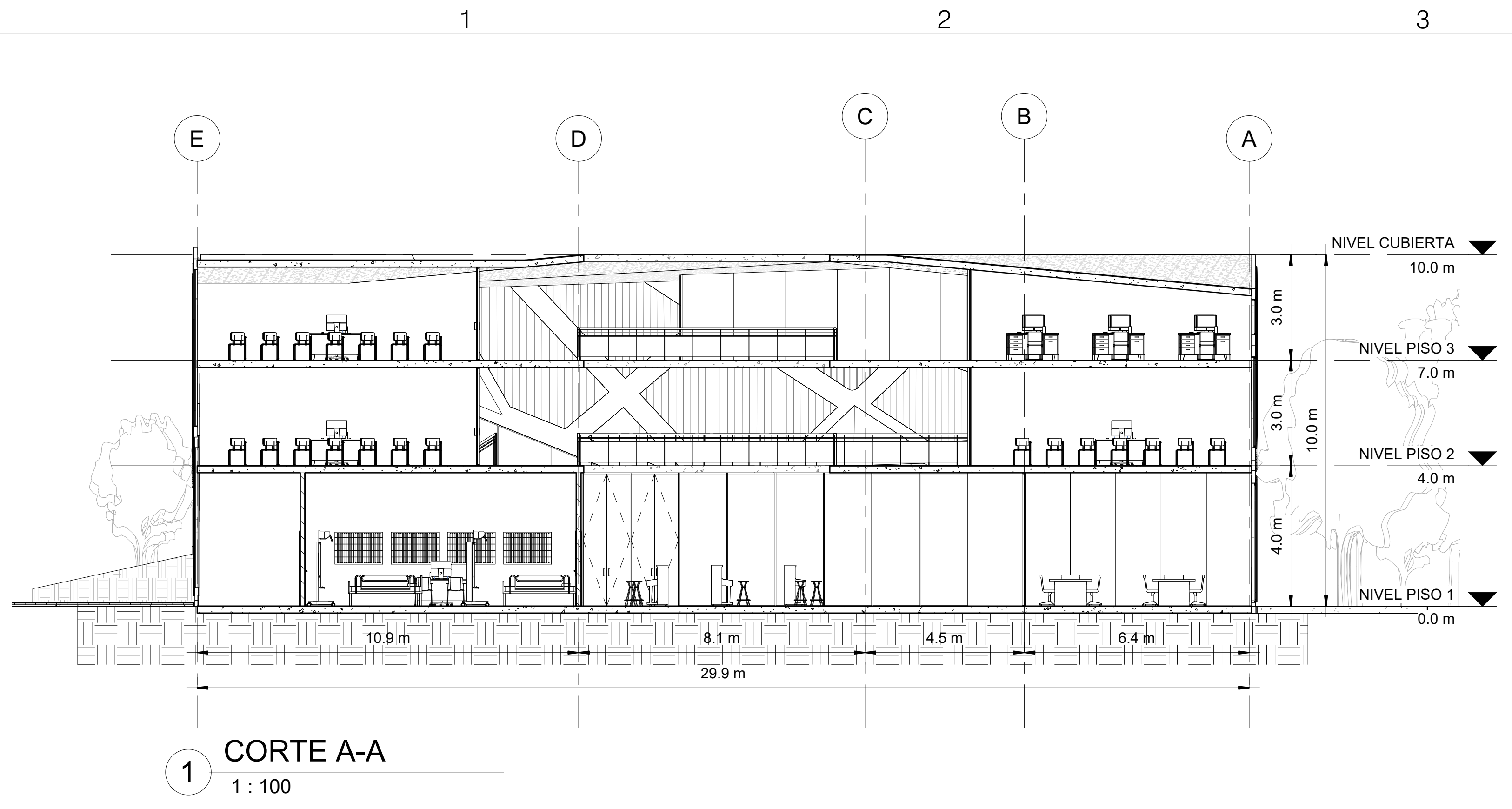

1 CORTE A-A
1 : 100

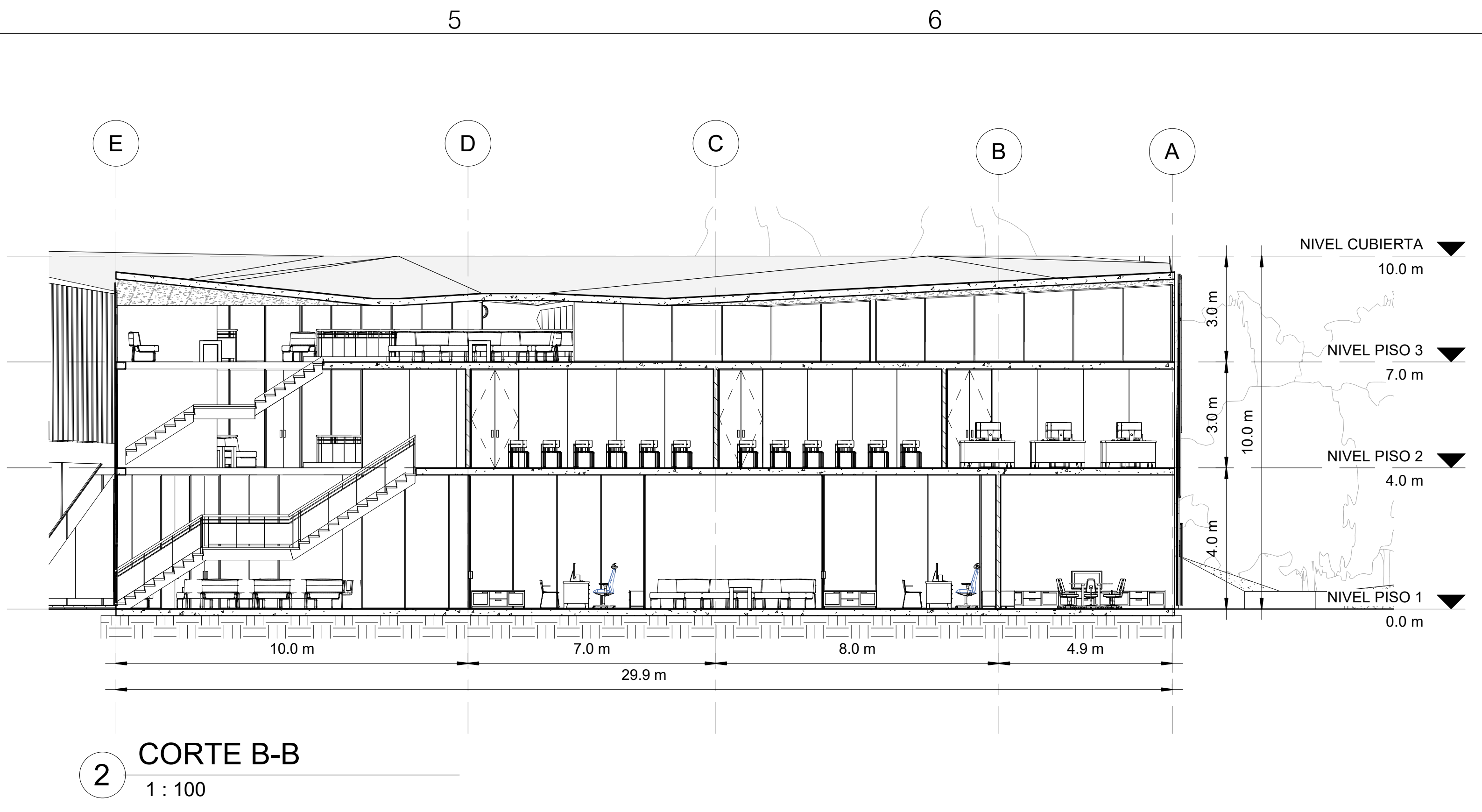

2 CORTE B-B
1 : 100

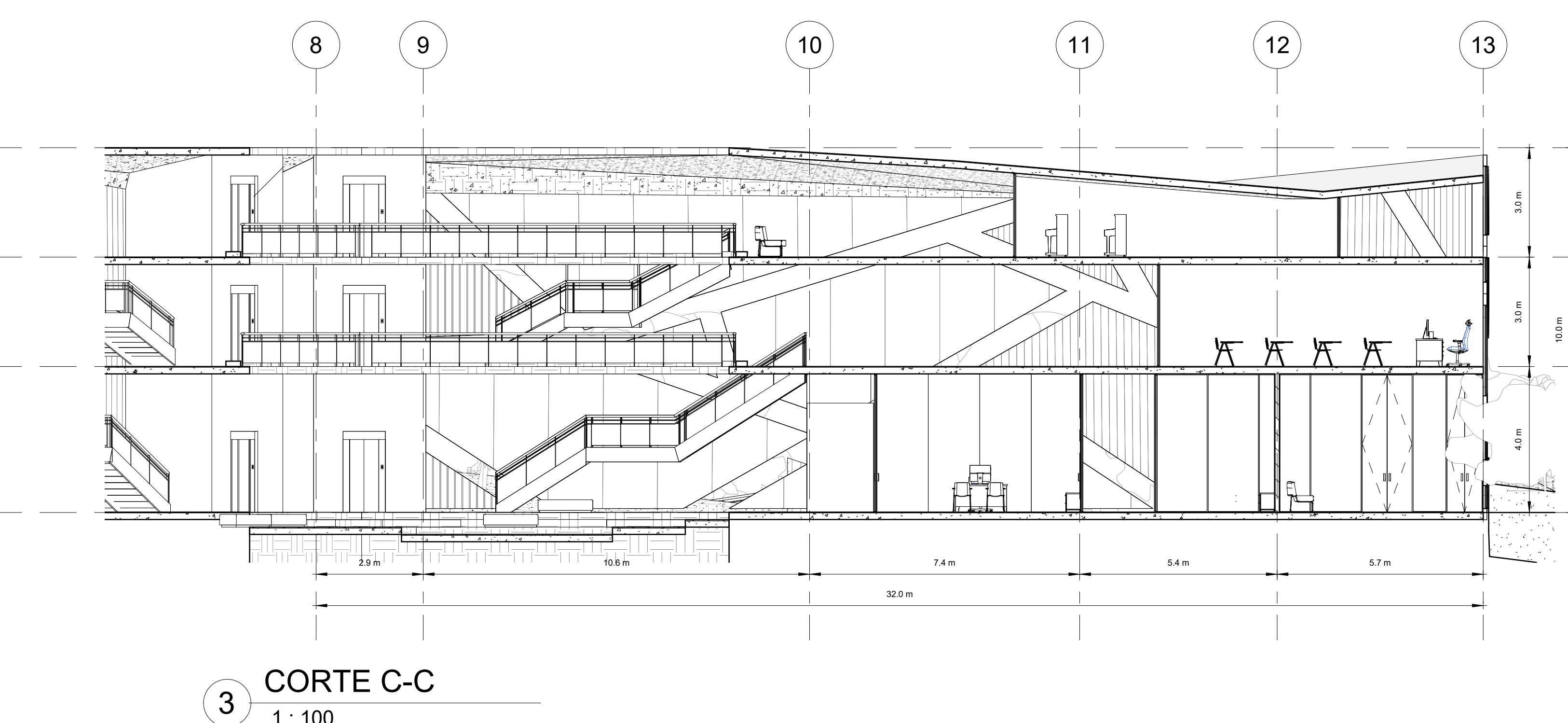

3 CORTE C-C
1 : 100

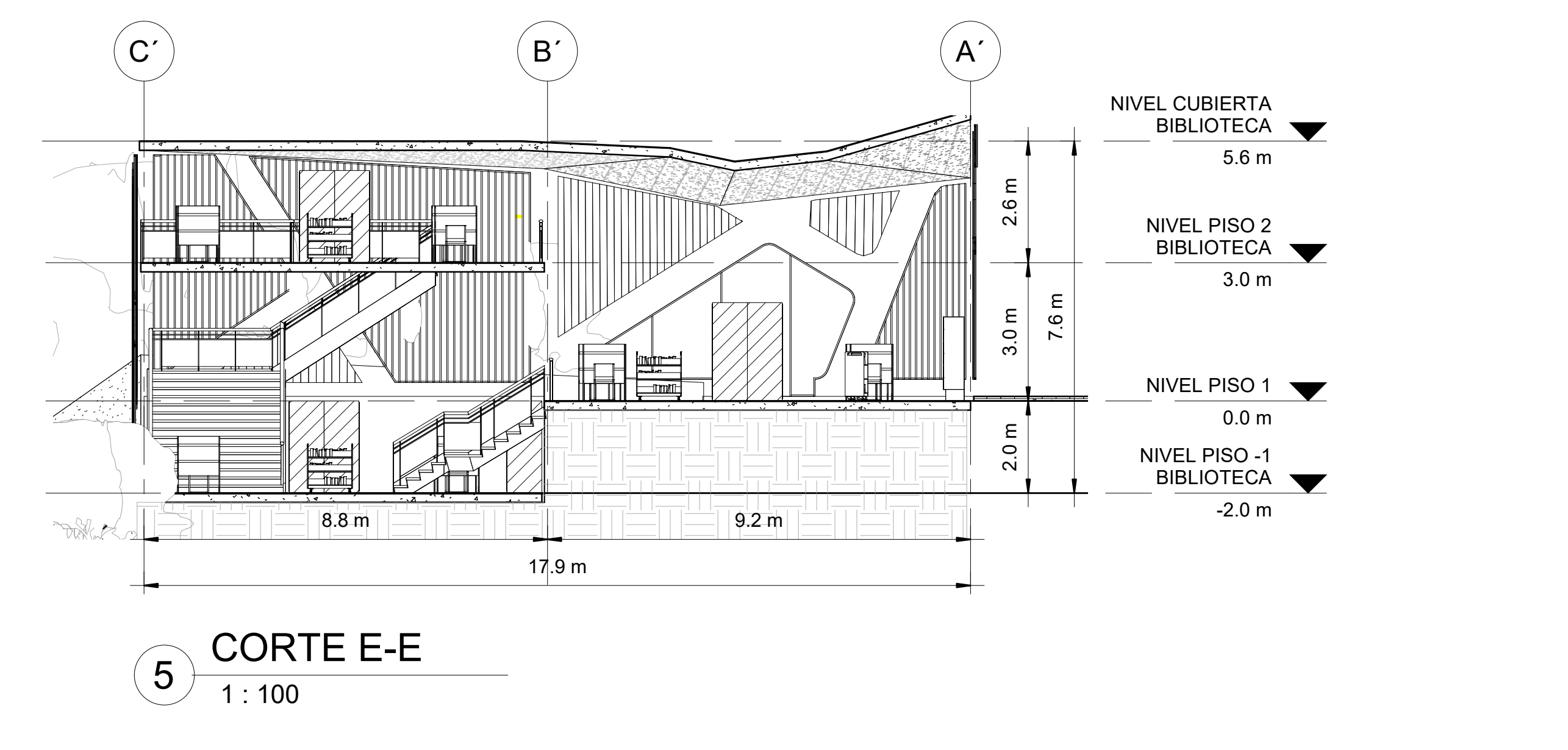

5 CORTE E-E
1 : 100

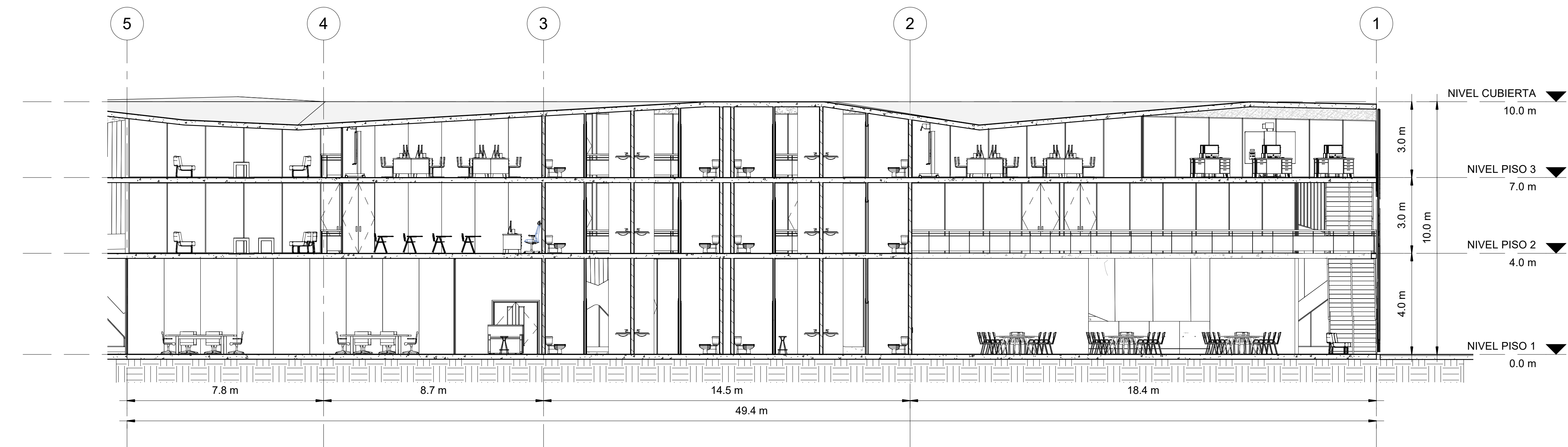

4 CORTE D-D
1 : 100

CONTIENE		SECCIONES 1	
OBSERVACIONES		FECHA INDICADA	
REVISION		11/12/19	
OBSERVACIONES:		ARQ. ALVARO JAVIER BOJANOS PALACIOS	
PROFESOR:		ARQ. ALVARO JAVIER BOJANOS PALACIOS	
ESTUDIANTES:		NEVER FABIAN OVALLE PINEDA COD. 1.019.080.398	
		DIANA PAOLA PARCO MENDEZ COD. 1.019.080.398	
PROYECTO		CENTRO DE EDUCACIÓN TECNOLÓGICA MONSIEU - BOYACA	
UNIVERSIDAD		La Gran Colombia	
REVISION		PLANCHAS	
A107		02	

1

2

3

4

5

6

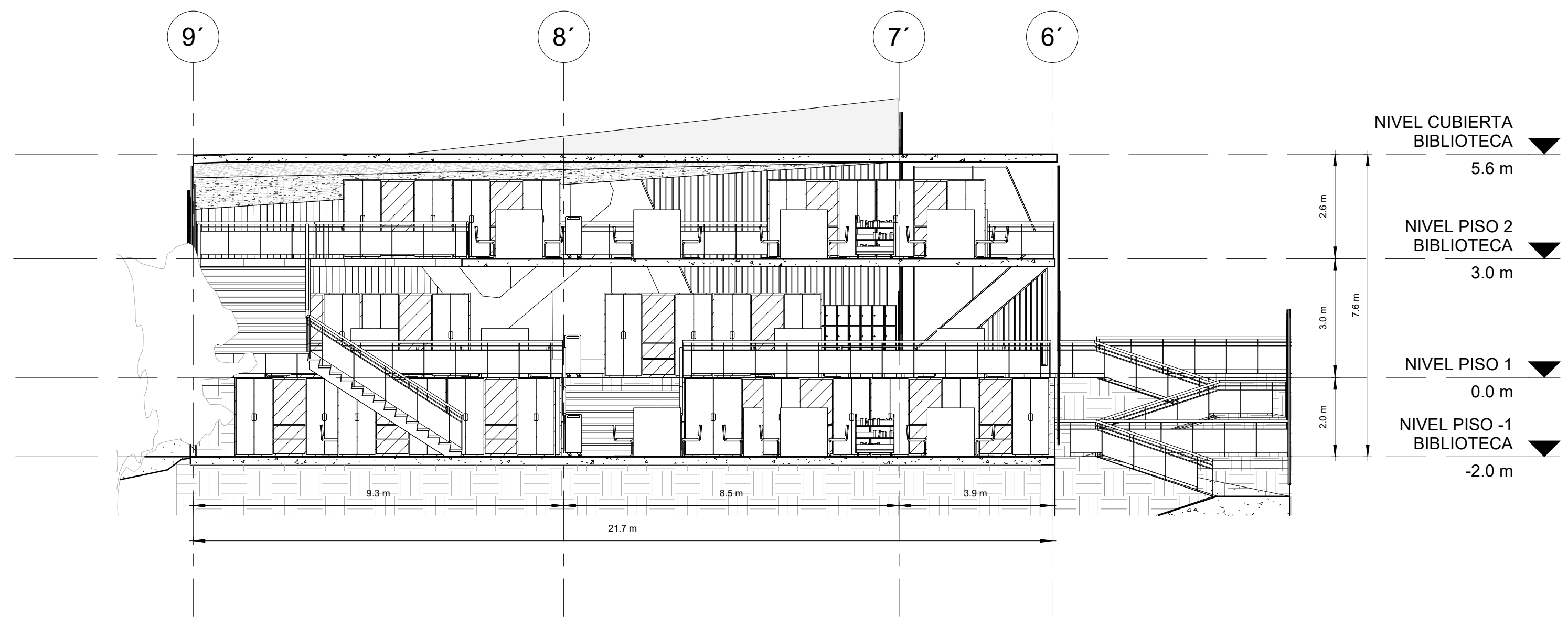

1 CORTE F-F
1:100

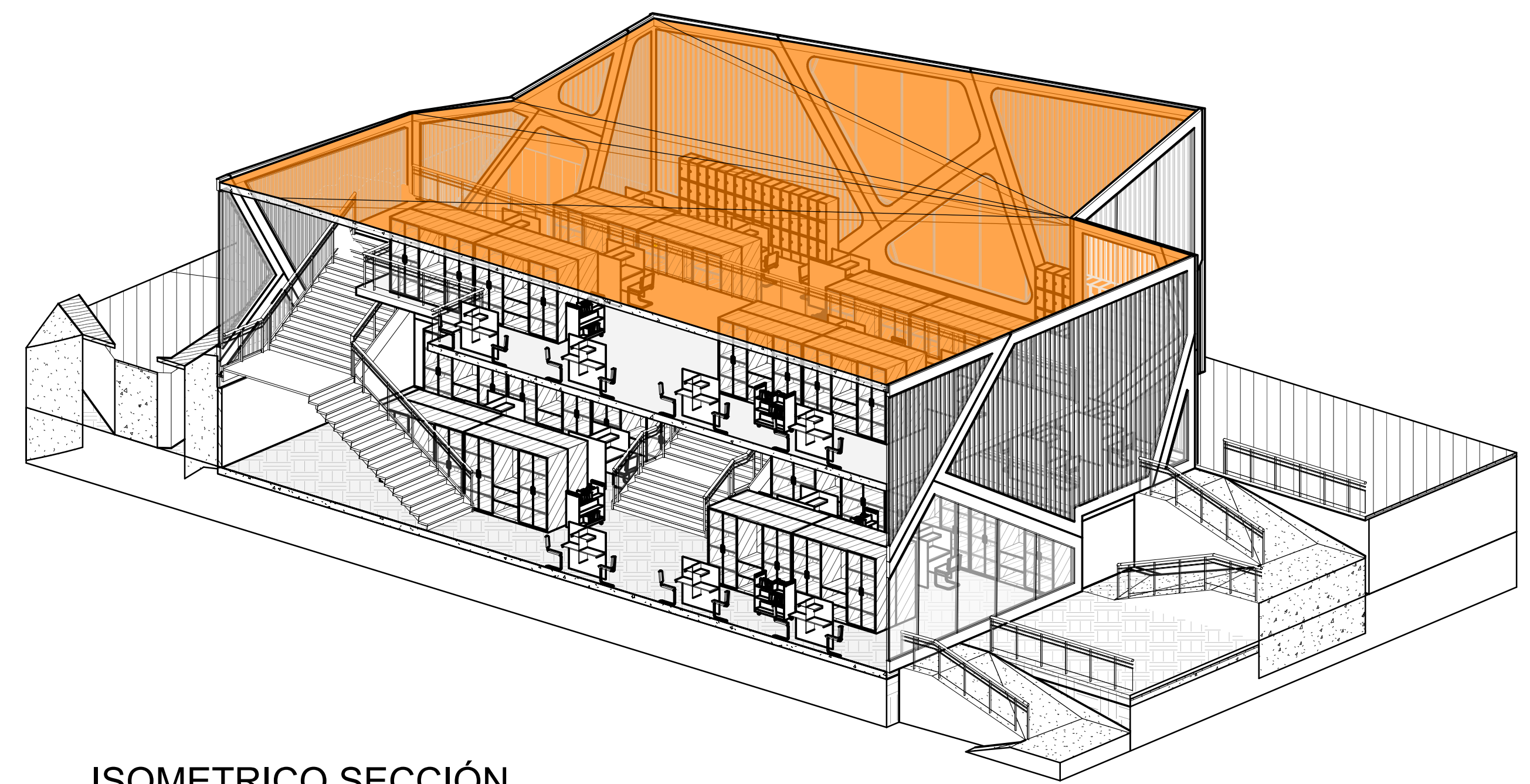

5 ISOMETRICO SECCIÓN
F-F

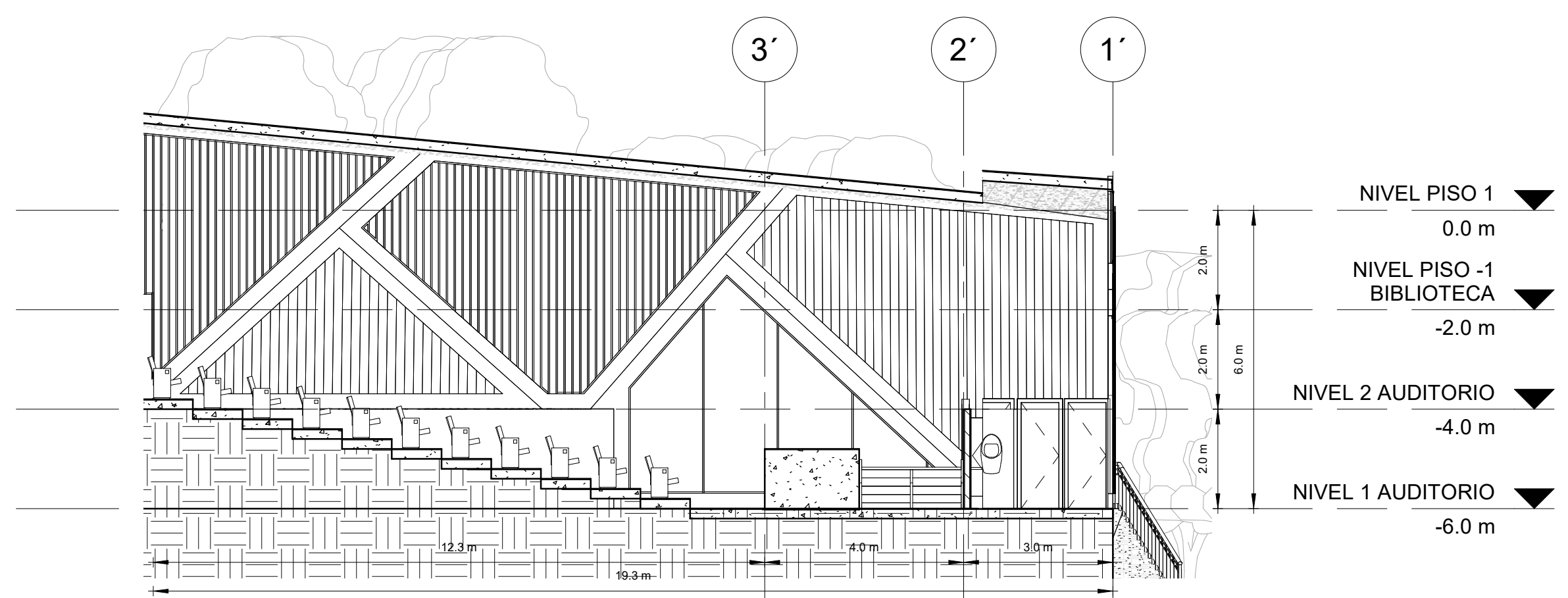

2 CORTE G-G
1:100

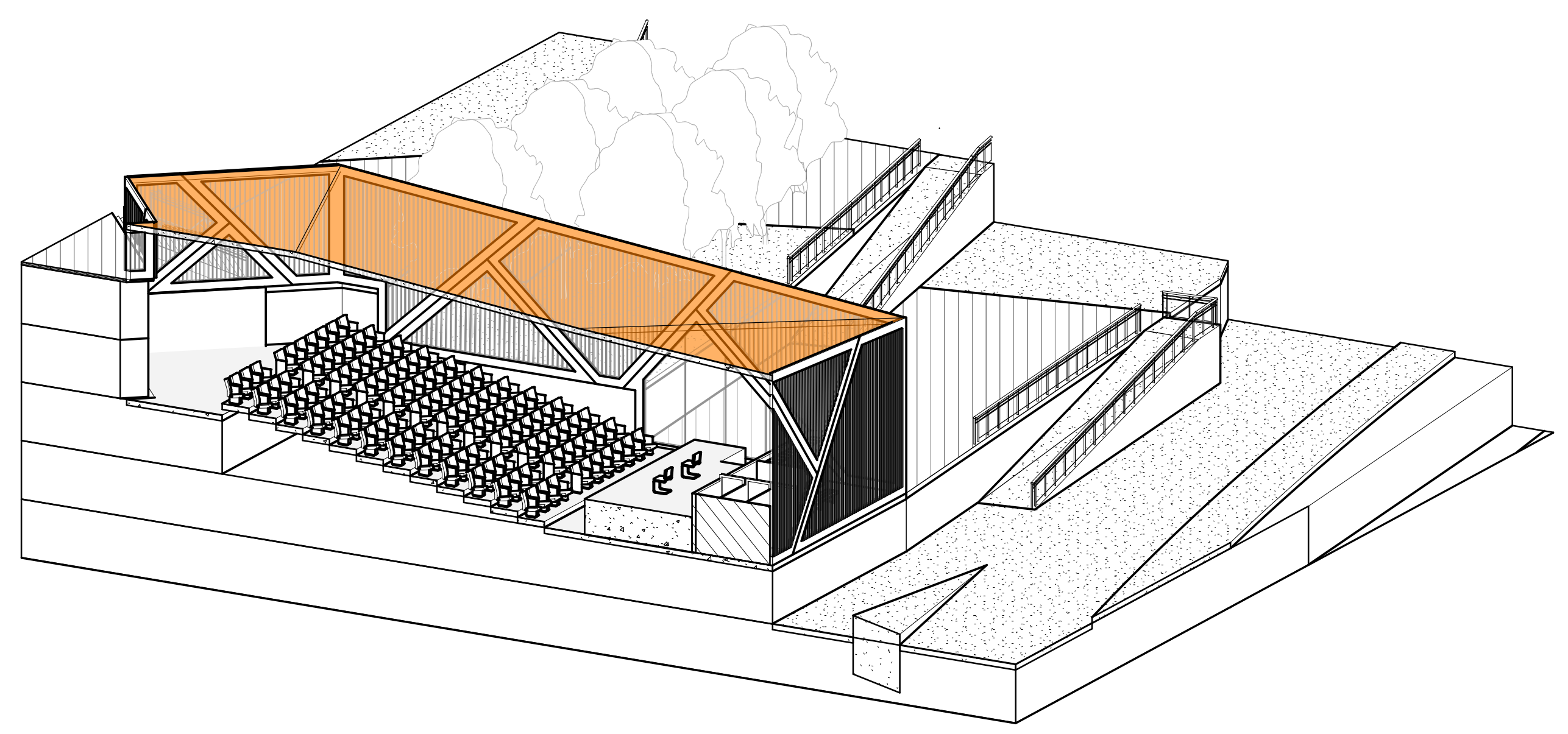

4 ISOMETRICO SECCIÓN
G-G

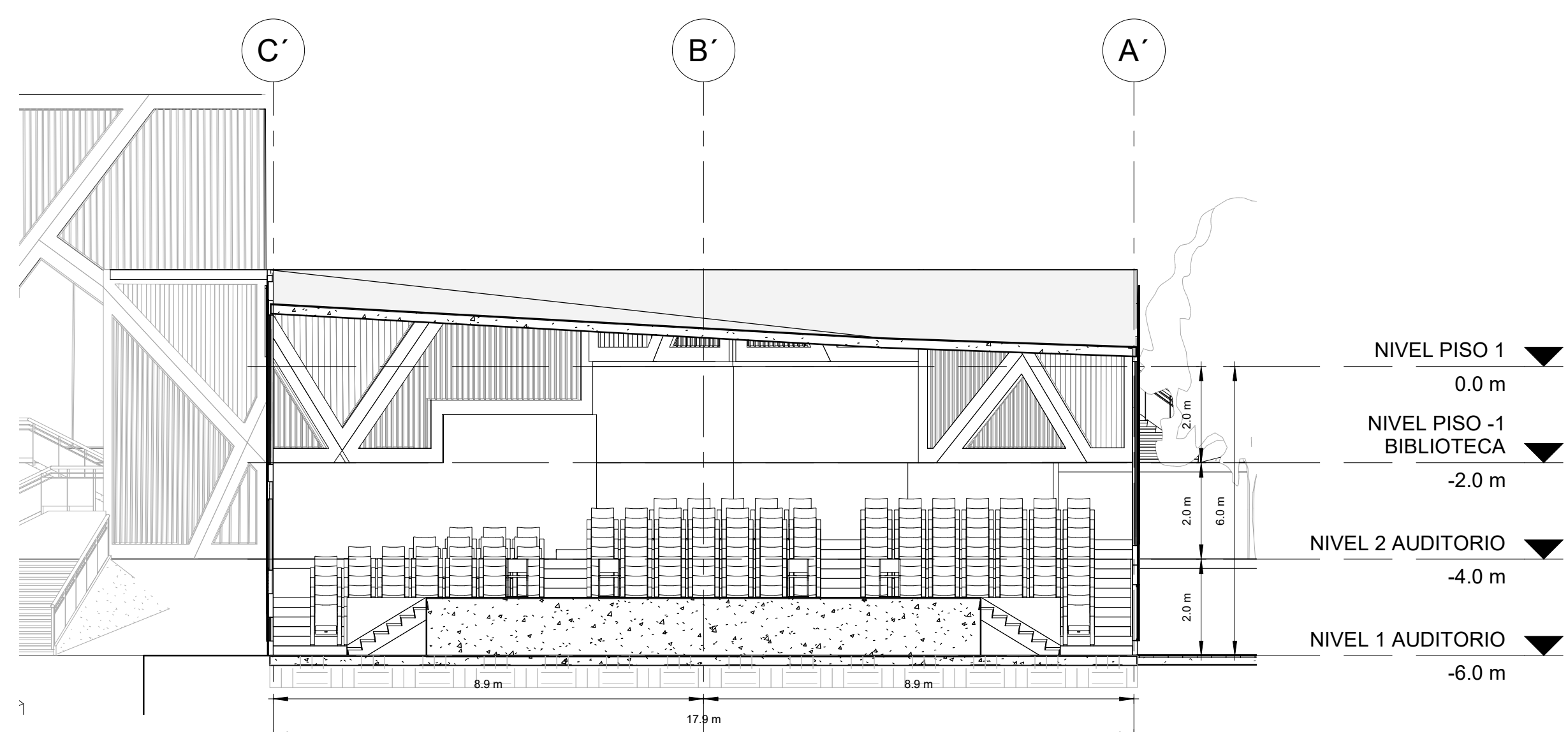

3 CORTE H-H
1:100

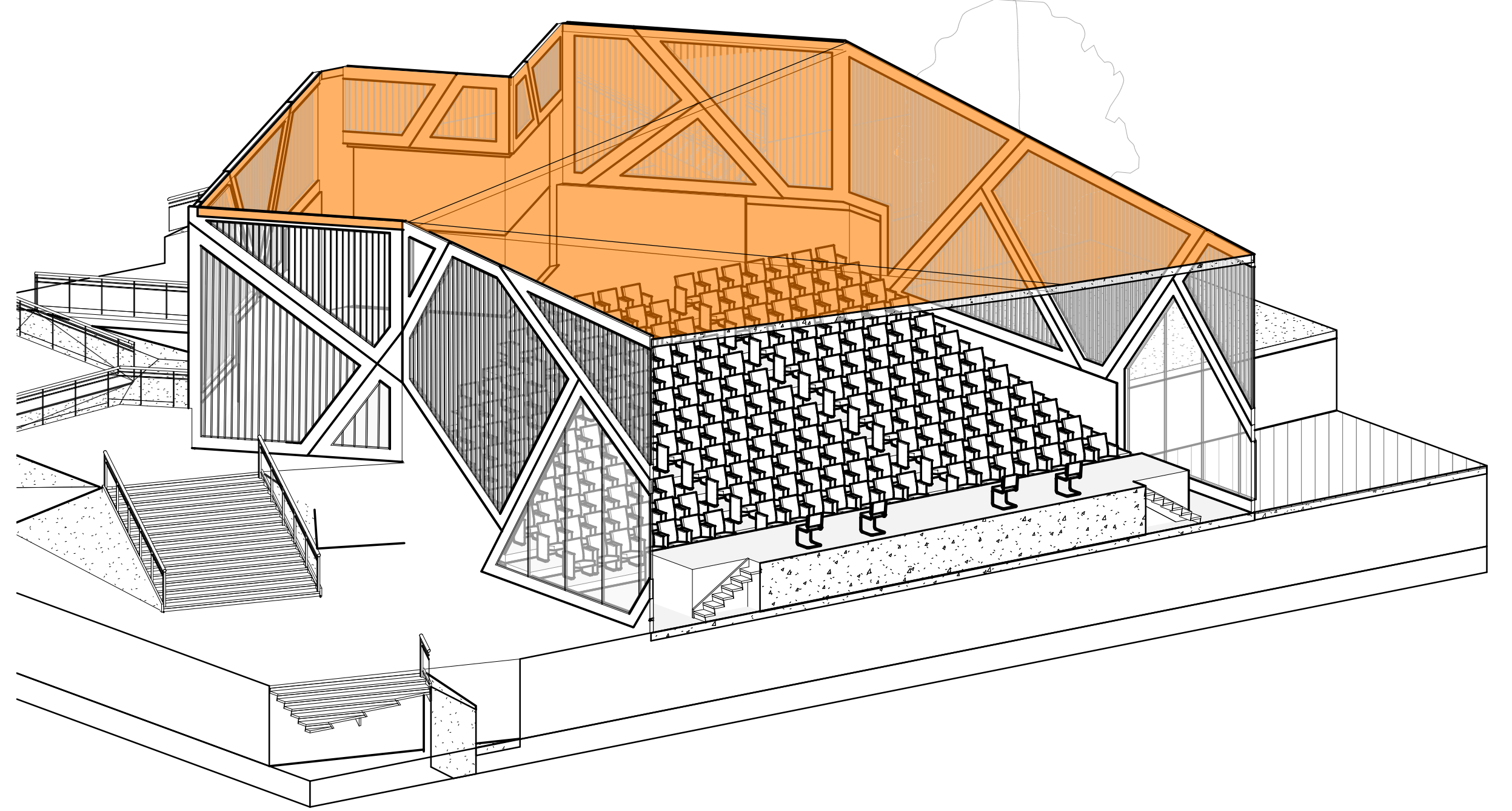

6 ISOMETRICO SECCIÓN
H-H

BOIV		NOVIEMBRE	
CONTIENE	SECCIONES 2	ESCALA	FECHA
OBSERVACIONES		INDICADA	12/04/19
REVISION			
OBSERVACIONES:			
PROFESOR:	ARQ. ALVARO JAVIER BOLAÑOS PALACIOS		
ESTUDIANTE:	NEVER FABIAN OVALLE PINEDA COD. 1.019.080.398		
	DIANA PAOLA PARCO MENDEZ COD. 1.019.080.398		
PROYECTO	CENTRO DE EDUCACIÓN TECNOLÓGICA MONGUI - BOYACA		
UNIVERSIDAD		La Gran Colombia	
			
REVISION	PLANCHAS	NO.	NO.
	A108		



1 LOCALIZACIÓN
1 : 250

NO. PLANCHA	001V	NO. DISEÑO	NO. 001/00
CONTIENE	LOCALIZACIÓN	ESCALA INDICADA	FECHA 1/11/19
OBSERVACIONES			
REVISIÓN			
OBSERVACIONES:			
PROFESOR:	ARQ. ALVARO JAVIER BOLAÑOS PALACIOS		
ESTUDIANTES:	NEVER FABIAN OVALLE PINEDA COD. 1.019.080.398 DIANA PAOLA PARCO MENDEZ COD. 1.019.080.398		
PROYECTO	CENTRO DE EDUCACIÓN TECNOLÓGICA MONGUI - BOYACA		
REVISIÓN	A100	PLANCHAS	02

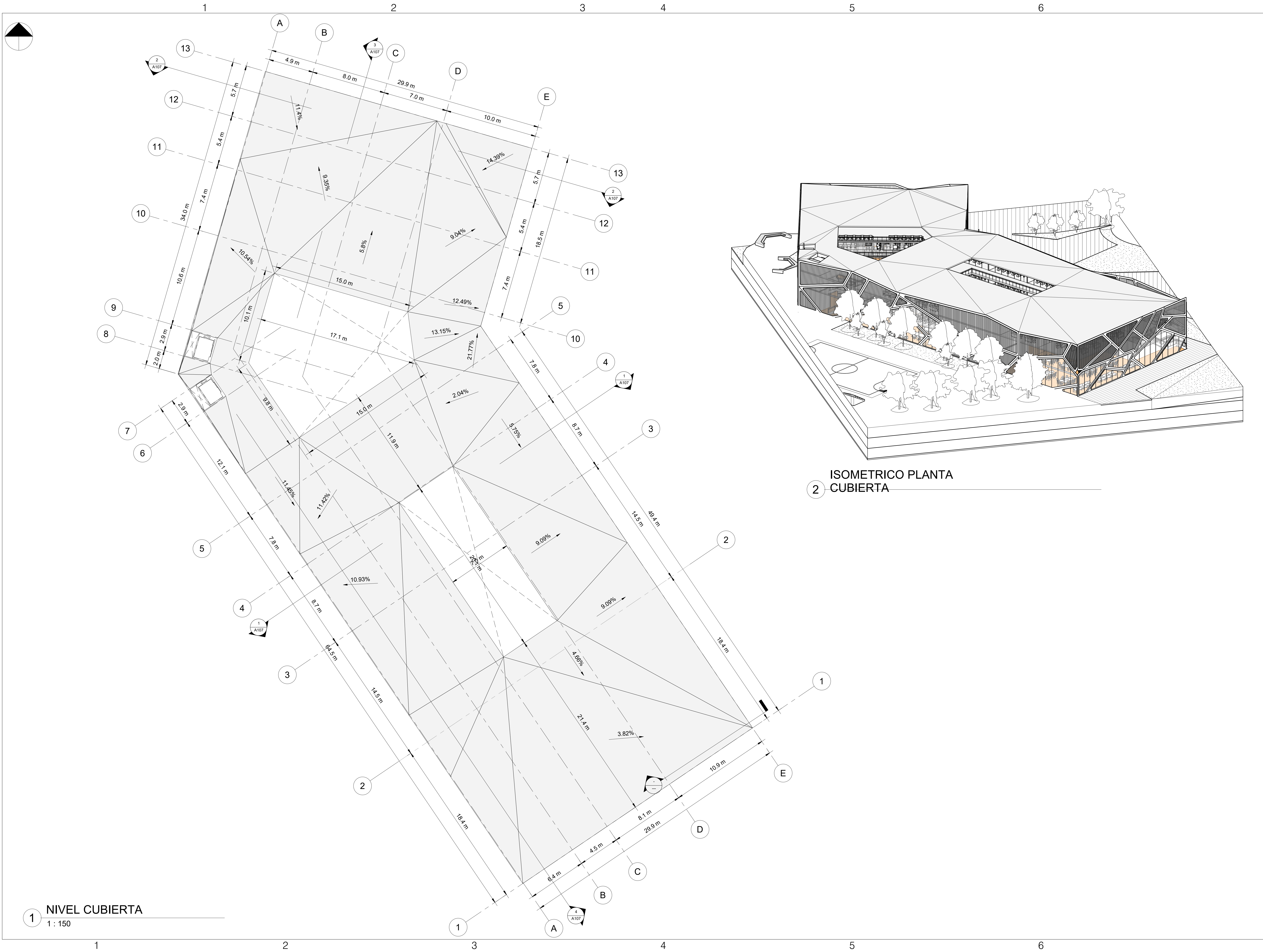

PROYECTO	CENTRO DE EDUCACIÓN TECNOLÓGICA MONSEJÚ - BOYACÁ
ESTUDIANTES:	NETER FABIAN OVALLE PINEDA COD. 1.019.080.398 DIANA PAOLA PARCO MENDEZ COD. 1.019.080.398
PROFESOR:	ARQ. ALVARO JAVIER BOLAÑOS PALACIOS
OBSERVACIONES:	
REVISIÓN	
OBSERVACIONES:	
CONTIENE	PLANTA CUBIERTA
ESCALA INDICADA	FECHA INDICADA
PLANCHILLA No. DC	1014

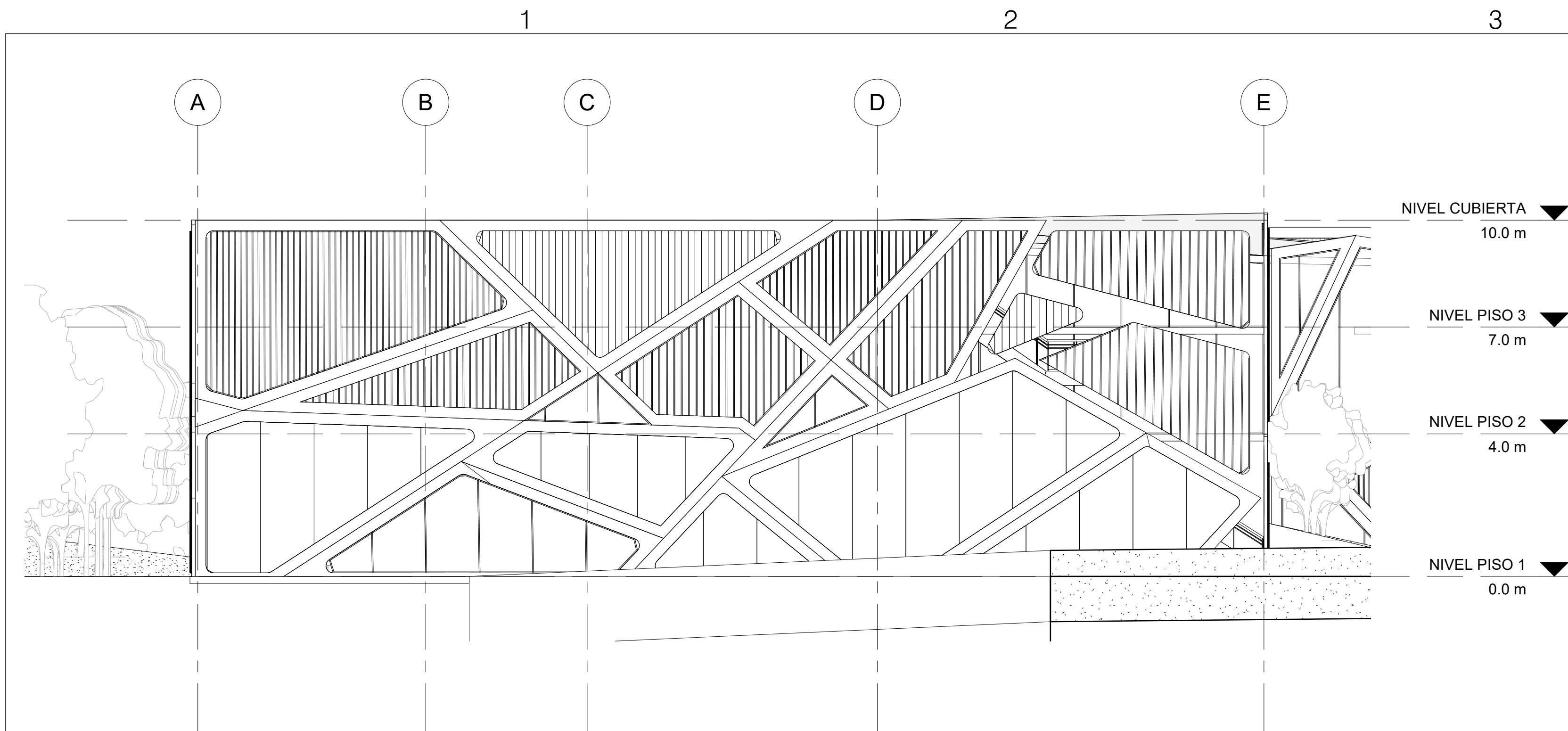

1 ALZADO NORTE
1:100

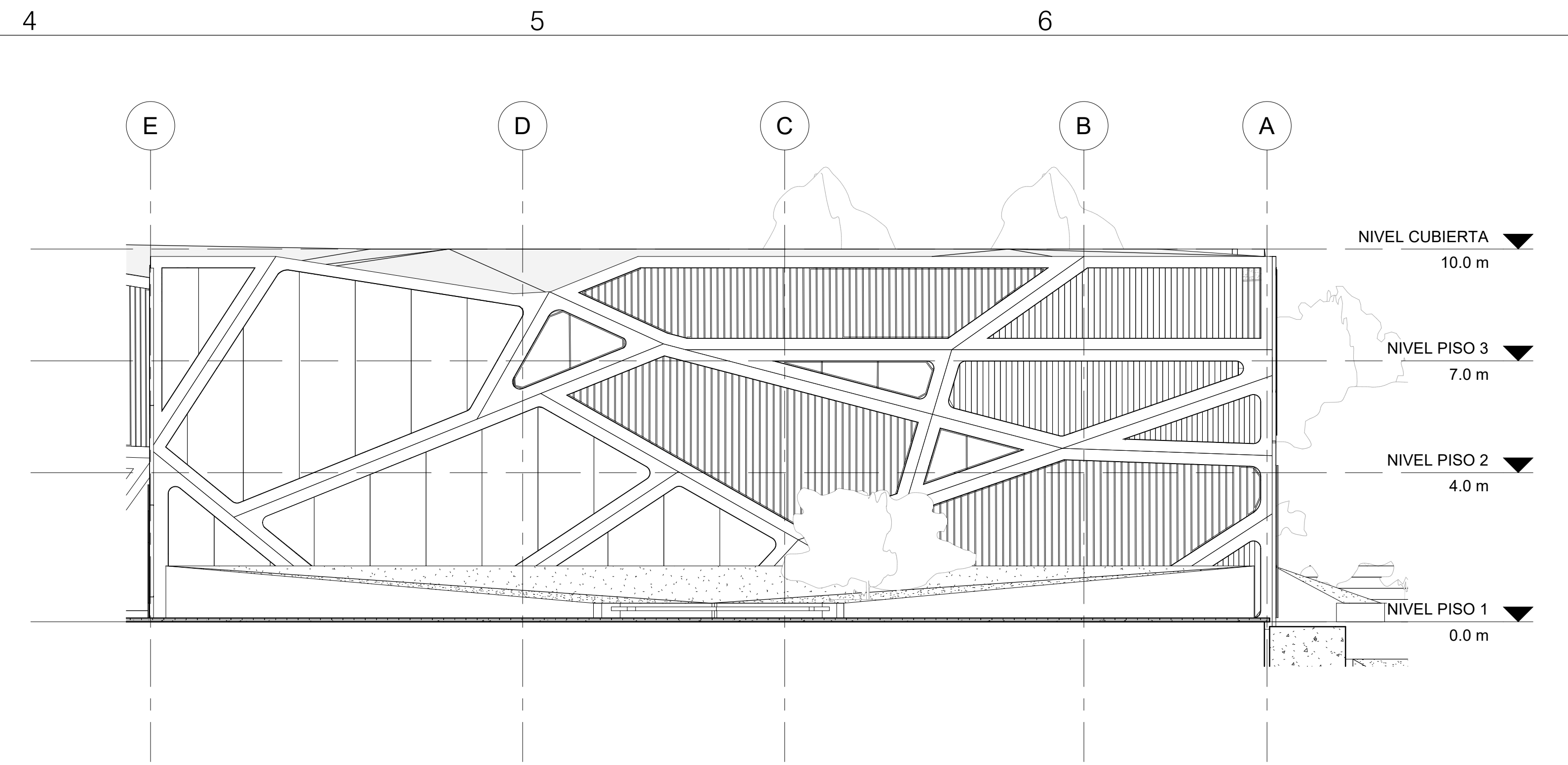

2 ALZADO SUR
1:100

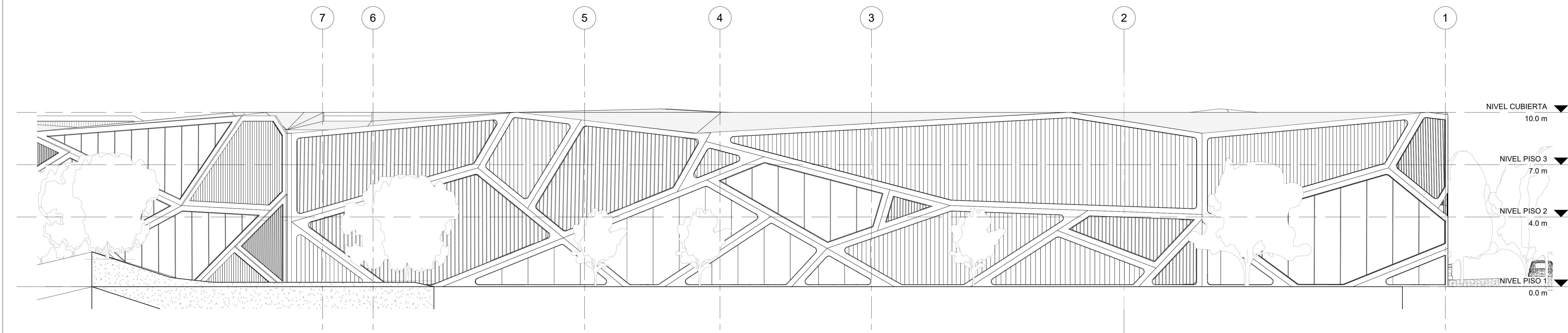

3 ALZADO OCCIDENTE
1:100

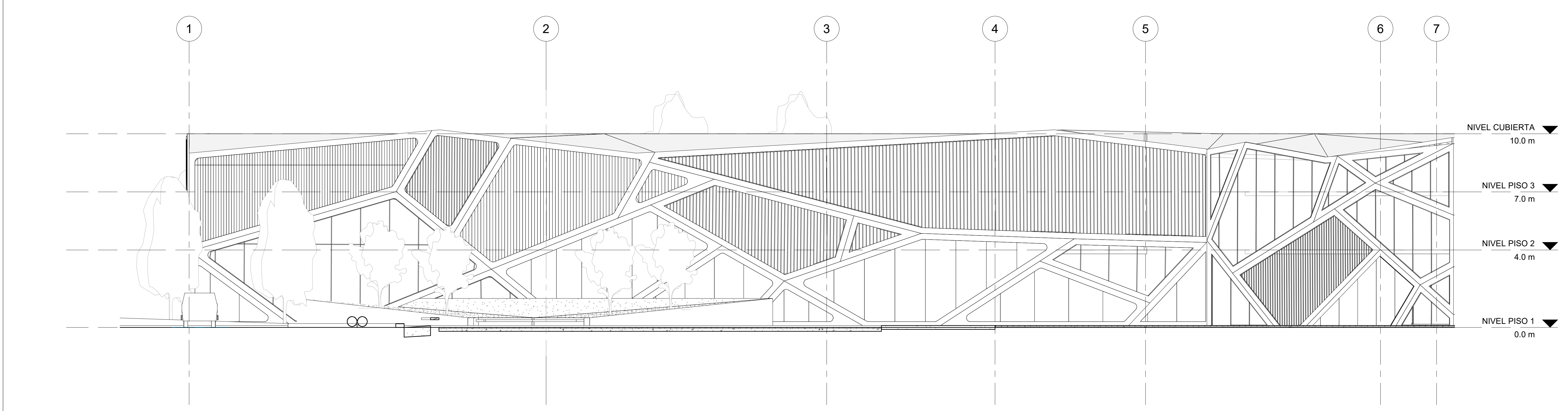

4 ALZADO ORIENTE
1:100

601V		NO. 2020	
CONTIENE	ALZADOS	ESCALA	FECHA
OBSERVACIONES:		INDICADA	
REVISIÓN		11/27/19	
OBSERVACIONES:			
PROFESOR:		ARQ. ALVARO JAVIER BOLAÑOS PALACIOS	
ESTUDIANTES:		NEVER FABIAN OVALLE PINEDA COD. 1.019.080.398 DIANA PAOLA PARCO MENDEZ COD. 1.019.080.398	
PROYECTO		CENTRO DE EDUCACIÓN TECNOLÓGICA MONGUI - BOYACA	
UNIVERSIDAD		La Gran Colombia	
REVISIÓN		PLANCHAS	
A109		02	

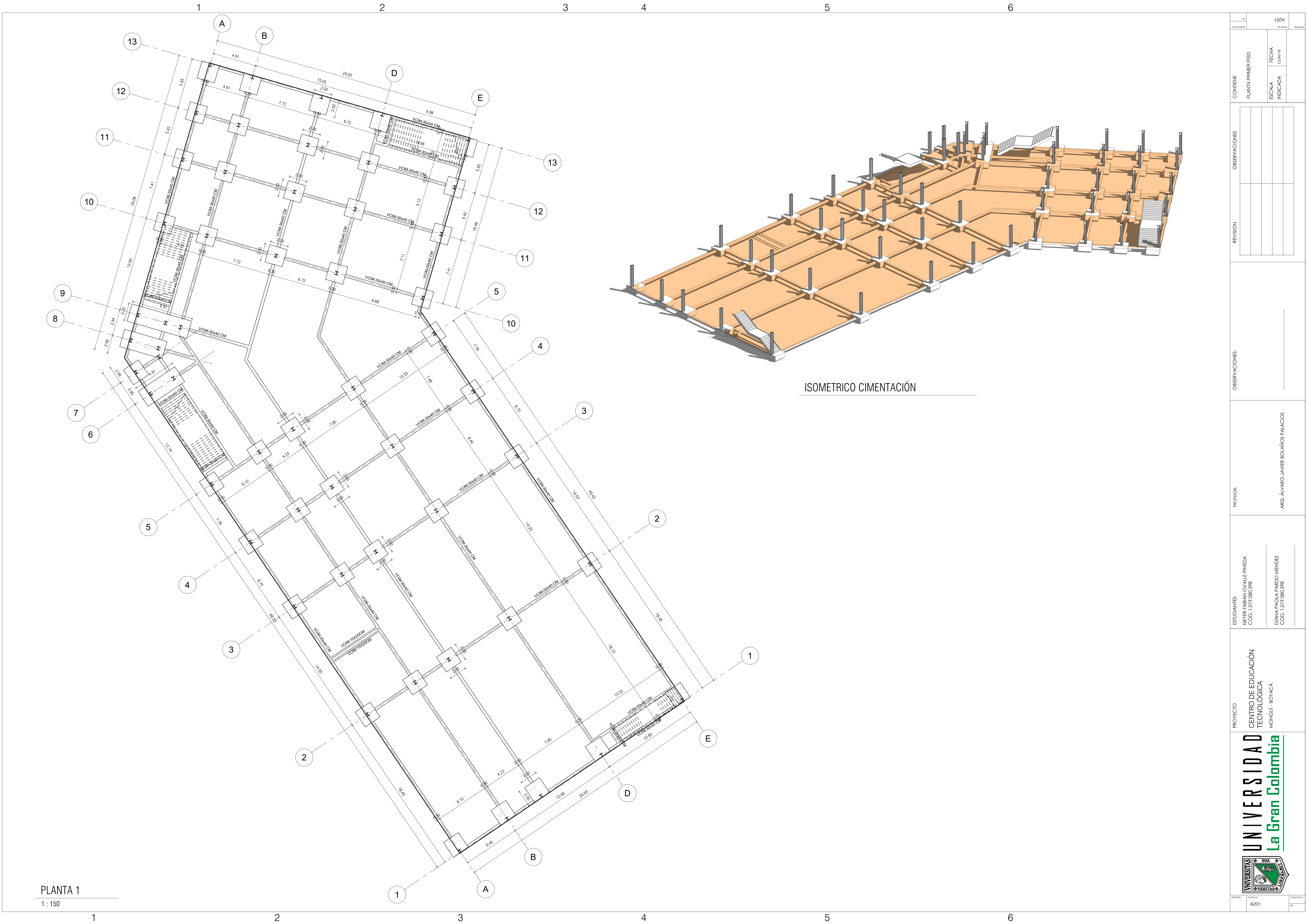

PLANTA 1
1:150

ISOMETRICO CIMENTACIÓN

NO		102V	
CONTIENE		PLANTA PRIMER PISO	FECHA
OBSERVACIONES		ESCALA	INDICADA
REVISIÓN			
OBSERVACIONES:			
PROFESOR:		ARQ. ALVARO JAVIER BOLAÑOS PALACIOS	
ESTUDIANTES:		NETER FABIAN OVALLE PINEDA COD. 1.019.080.398	DIANA PAOLA PARCO MENDEZ COD. 1.019.080.398
PROYECTO		CENTRO DE EDUCACIÓN TECNOLÓGICA MONGUI - BOYACA	
UNIVERSIDAD		La Gran Colombia	
REVISIÓN	PLANCHAS	PLANCHAS	
A201	01	01	

PLANTA 2
1:150

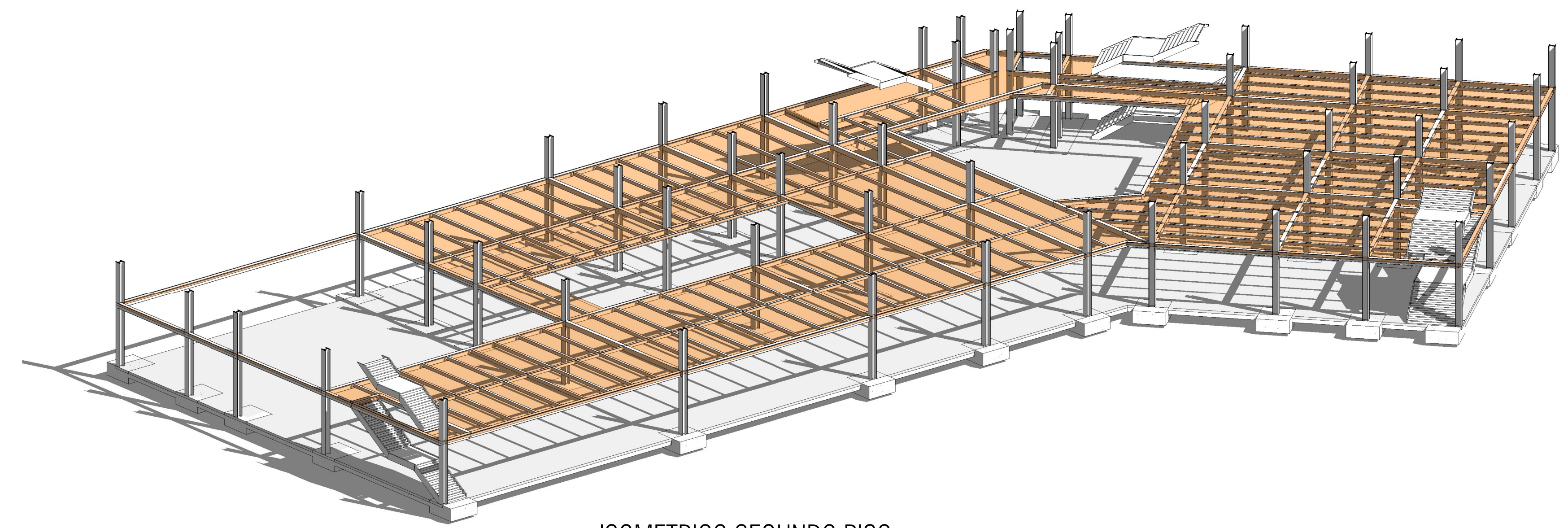
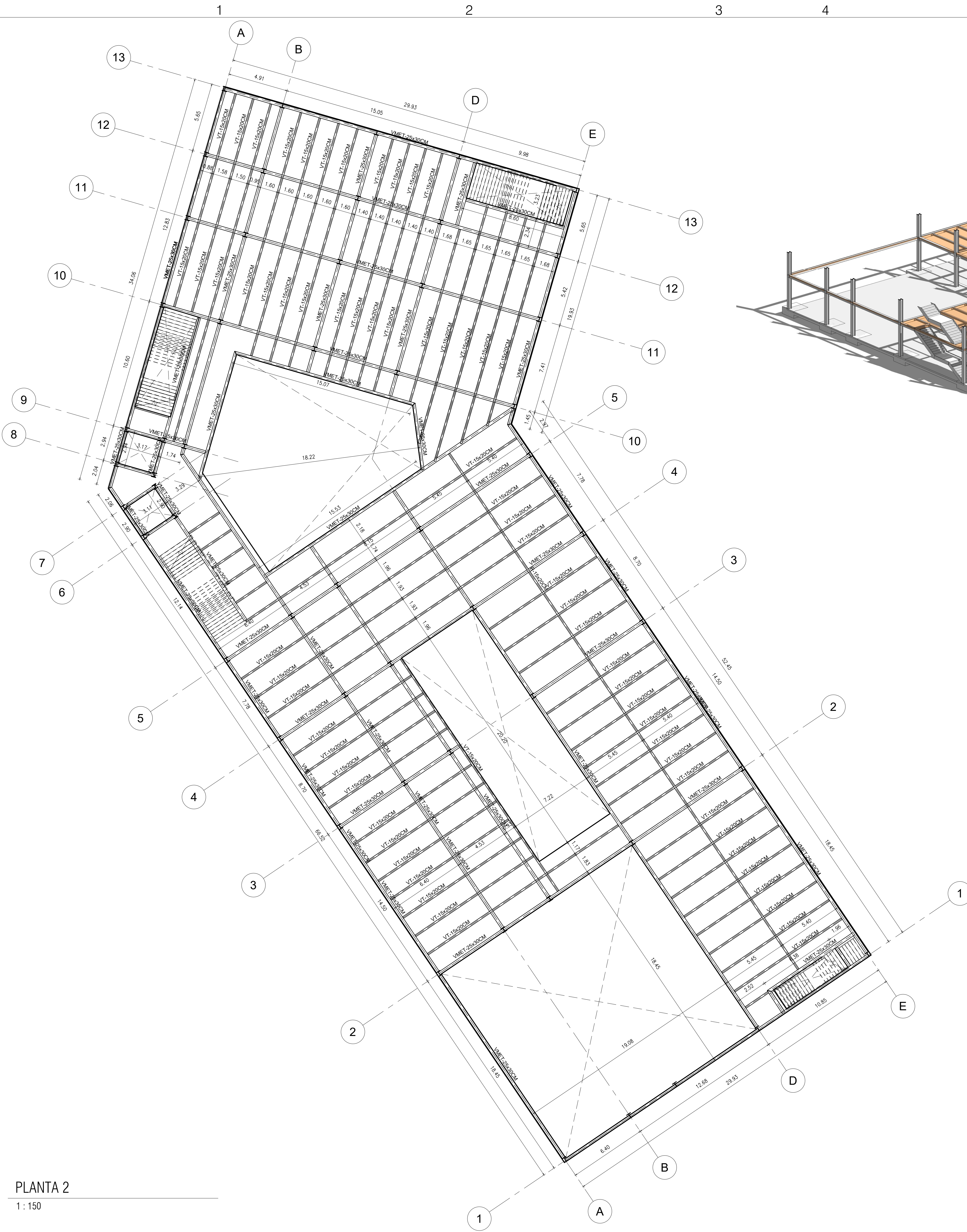

ISOMETRICO SEGUNDO PISO

PROYECTO		CENTRO DE EDUCACIÓN TECNOLÓGICA MONGUI - BOYACA	
ESTUDIANTES:		NEVER FABIAN OVALLE PINEDA COD. 1.019.080.398 DIANA PAOLA PARCO MENDEZ COD. 1.019.080.398	
PROFESOR:		ARQ. ALVARO JAVIER BOLAÑOS PALACIOS	
OBSERVACIONES:			
REVISIÓN			
OBSERVACIONES			
CONTIENE		PLANTA SEGUNDO PISO	
ESCALA		INDICADA	
FECHA		12/04/19	
PLANCHAS		A202	

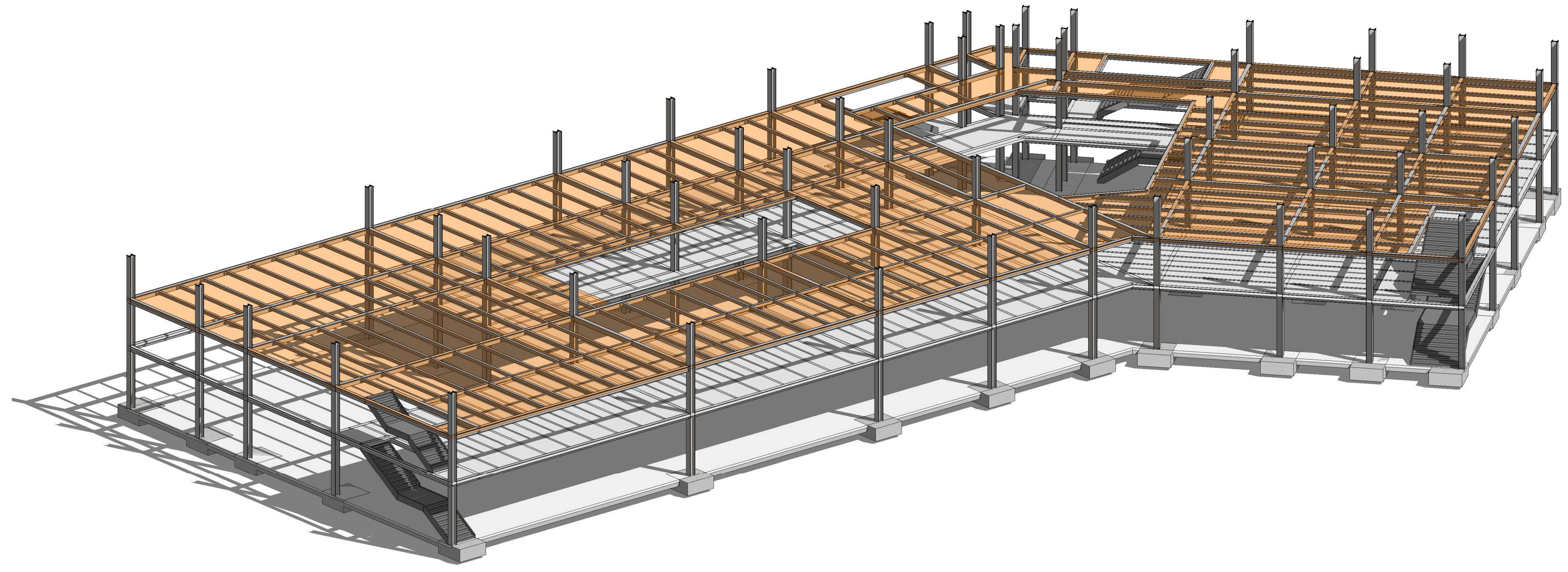
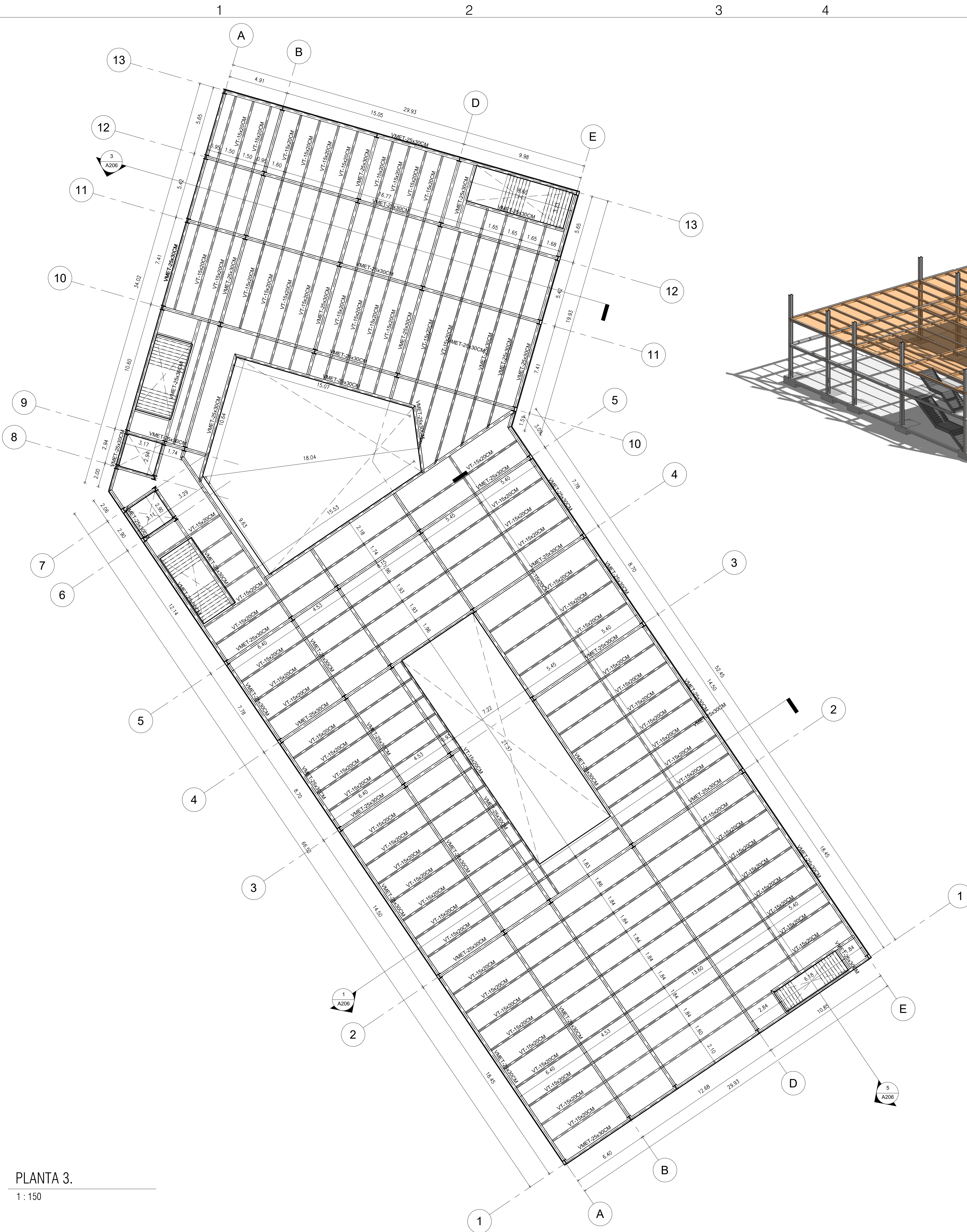

ISOMETRICO TERCER PISO

PLANTA 3.
1:150

CONTIENE		E02V	
PLANTA TERCER PISO		ESCALA	FECHA
OBSERVACIONES		INDICADA	12/04/19
REVISION			
OBSERVACIONES:			
PROFESOR:		ARQ. ALVARO JAVIER BOLAÑOS PALACIOS	
ESTUDIANTES:		NEVER FABIAN OVALLE PINEDA COD. 1.019.080.398 DIANA PAOLA PARCO MENDEZ COD. 1.019.080.398	
PROYECTO		CENTRO DE EDUCACIÓN TECNOLÓGICA MONGUI - BOYACA	
UNIVERSIDAD		La Gran Colombia	
REVISION	PLANTA	PLANCHAS	
A203		02	

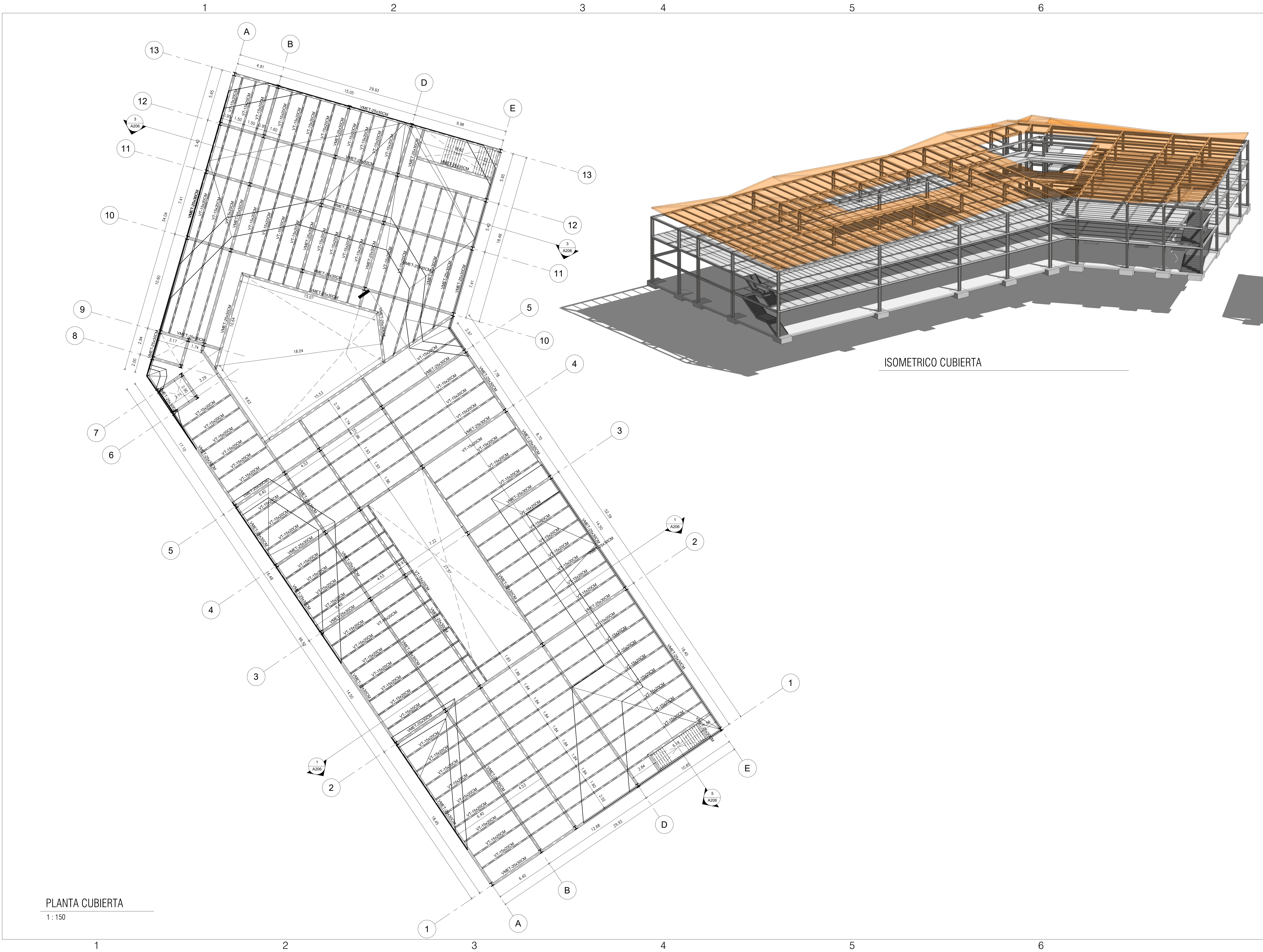

PLANTA CUBIERTA
1 : 150

ISOMETRICO CUBIERTA

PROYECTO		CENTRO DE EDUCACIÓN TECNOLÓGICA MONGUI - BOYACA	
ESTUDIANTES:		NETER FABIAN OVALLE PINEDA COD. 1.019.080.398 DIANA PAOLA PARCO MENDEZ COD. 1.019.080.398	
PROFESOR:		ARQ. ALVARO JAVIER BOLAÑOS PALACIOS	
OBSERVACIONES:			
REVISIÓN	OBSERVACIONES		
CONTIENE	PLANTA CUBIERTA		
ESCALA INDICADA	FECHA INDICADA		
10204	NOV/2019		

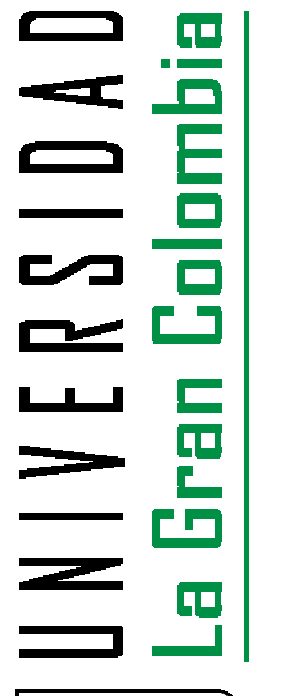

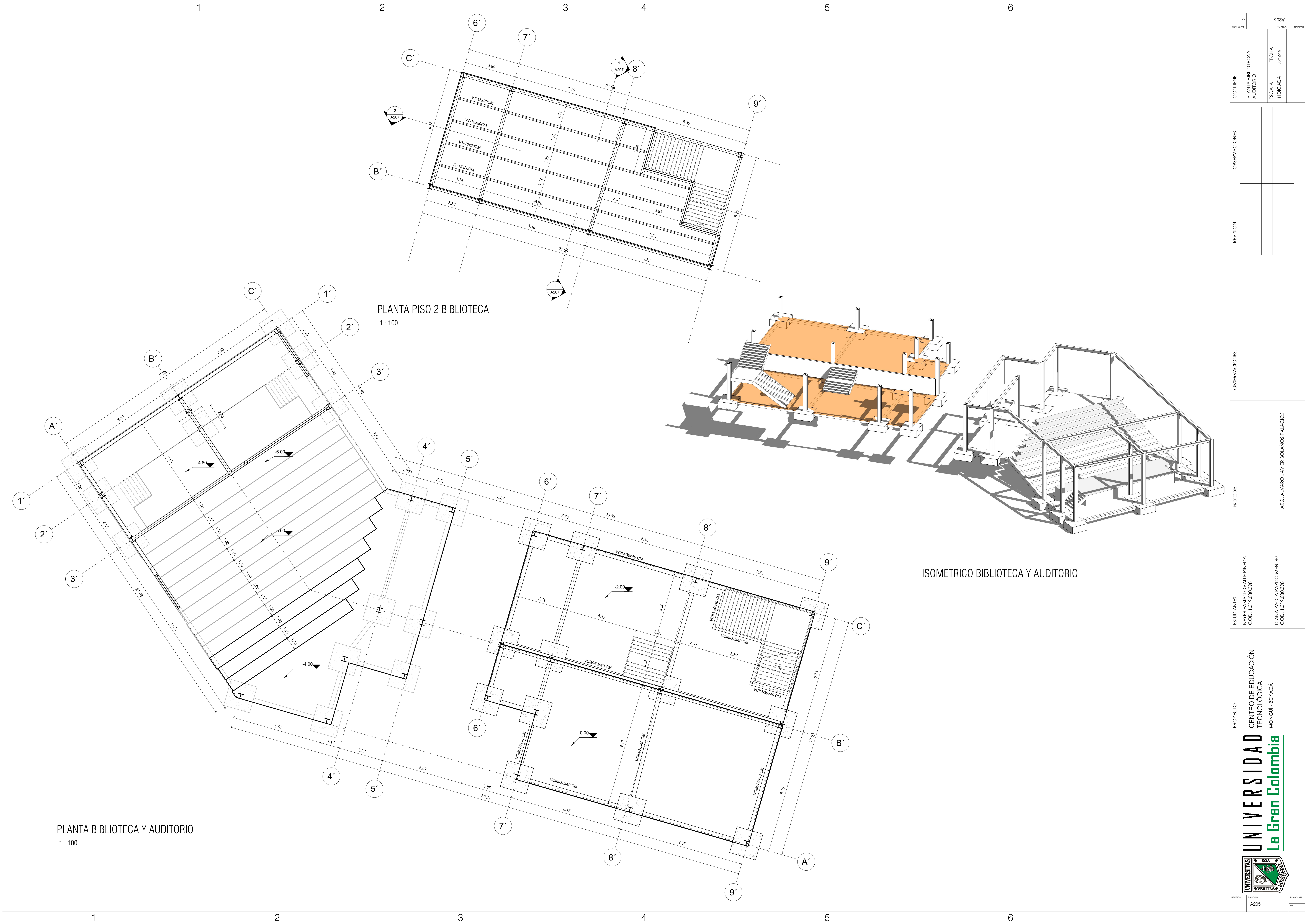

NO		502V	
CONTIENE		PLANTA BIBLIOTECA Y AUDITORIO	FECHA 05/12/19
OBSERVACIONES			ESCALA INDICADA
REVISION			
OBSERVACIONES:			
PROFESOR:		ARQ. ALVARO JAVIER BOLAÑOS PALACIOS	
ESTUDIANTES:		NEVER FABIAN OVALLE PINEDA COD. 1.0119.080.398	DIANA PAOLA PARCO MENDEZ COD. 1.0119.080.398
PROYECTO		CENTRO DE EDUCACIÓN TECNOLÓGICA MONGUI - BOYACA	
UNIVERSIDAD		La Gran Colombia	
REVISION	PLANCHAS	PLANCHAS NO.	
A205	02		

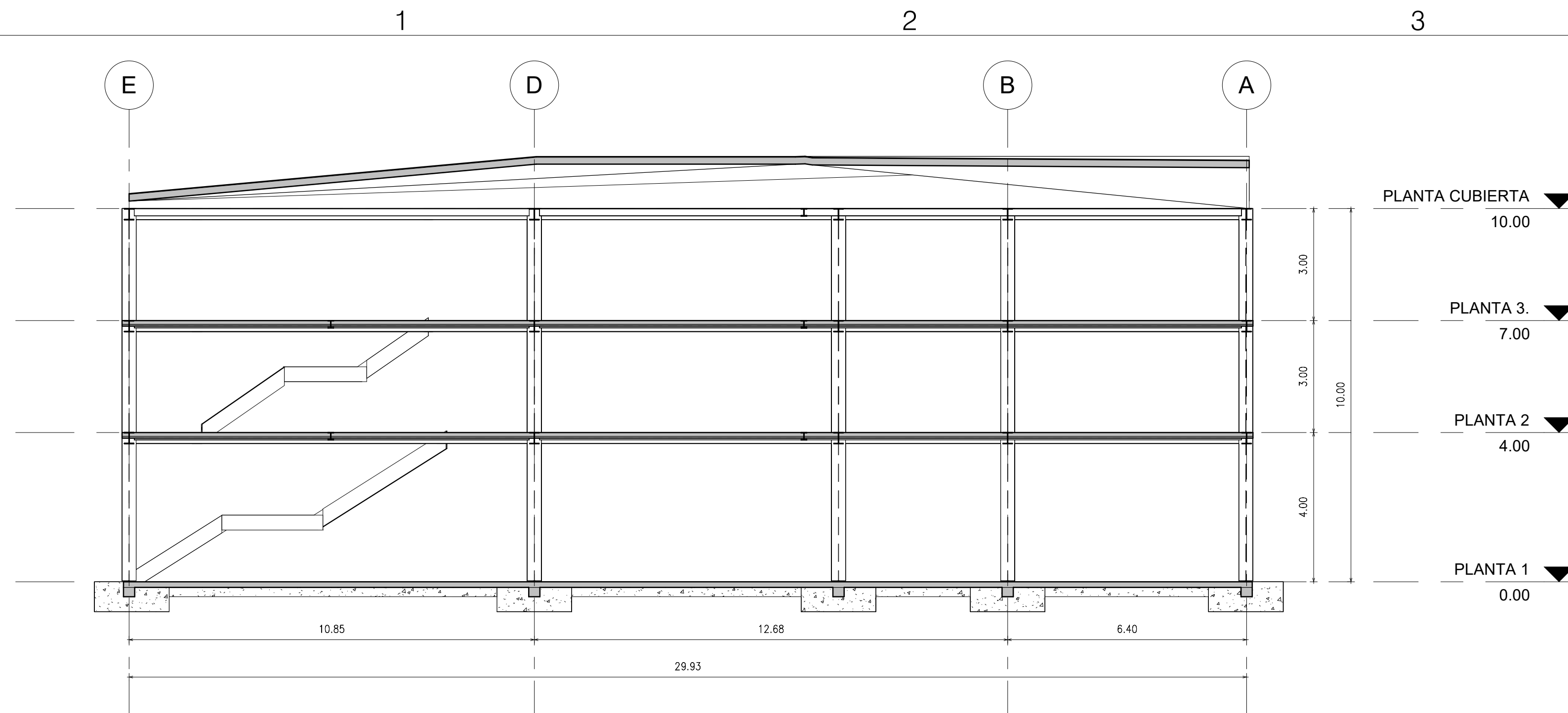

CORTE A-A

1:100

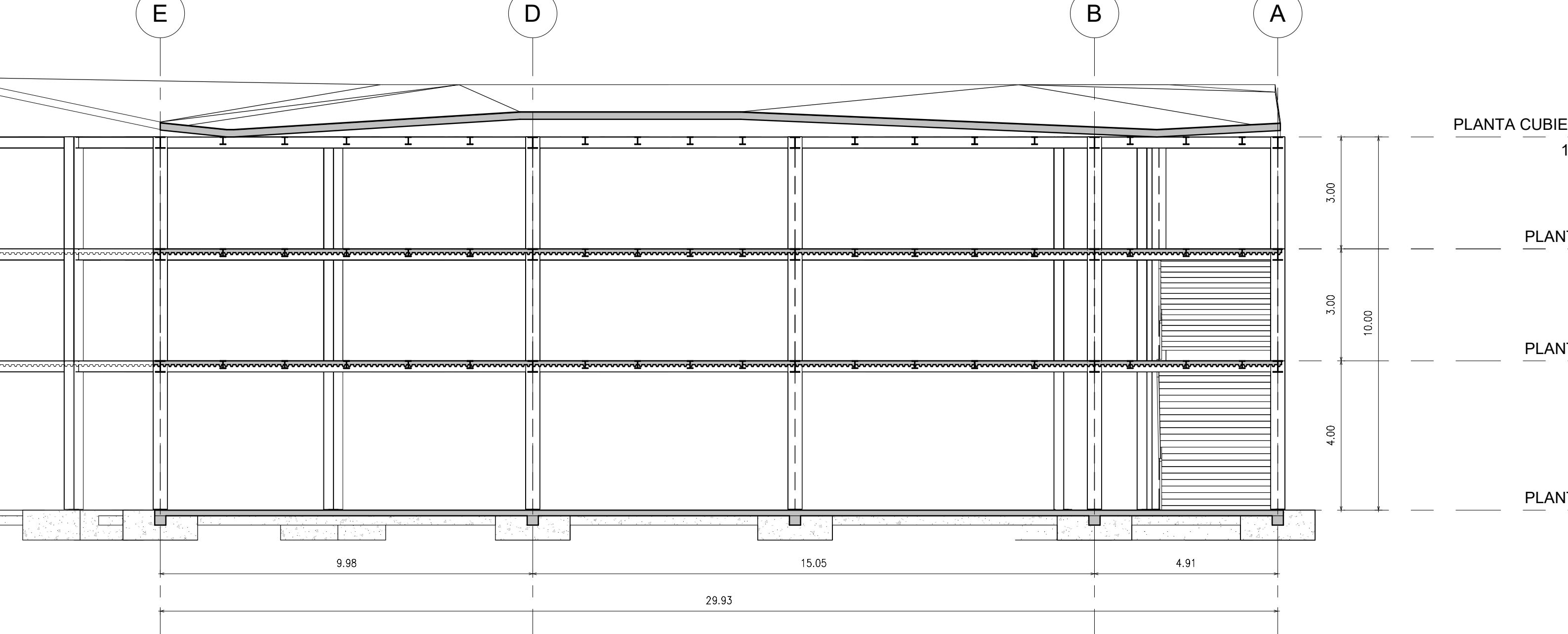

CORTE B-B

1:100

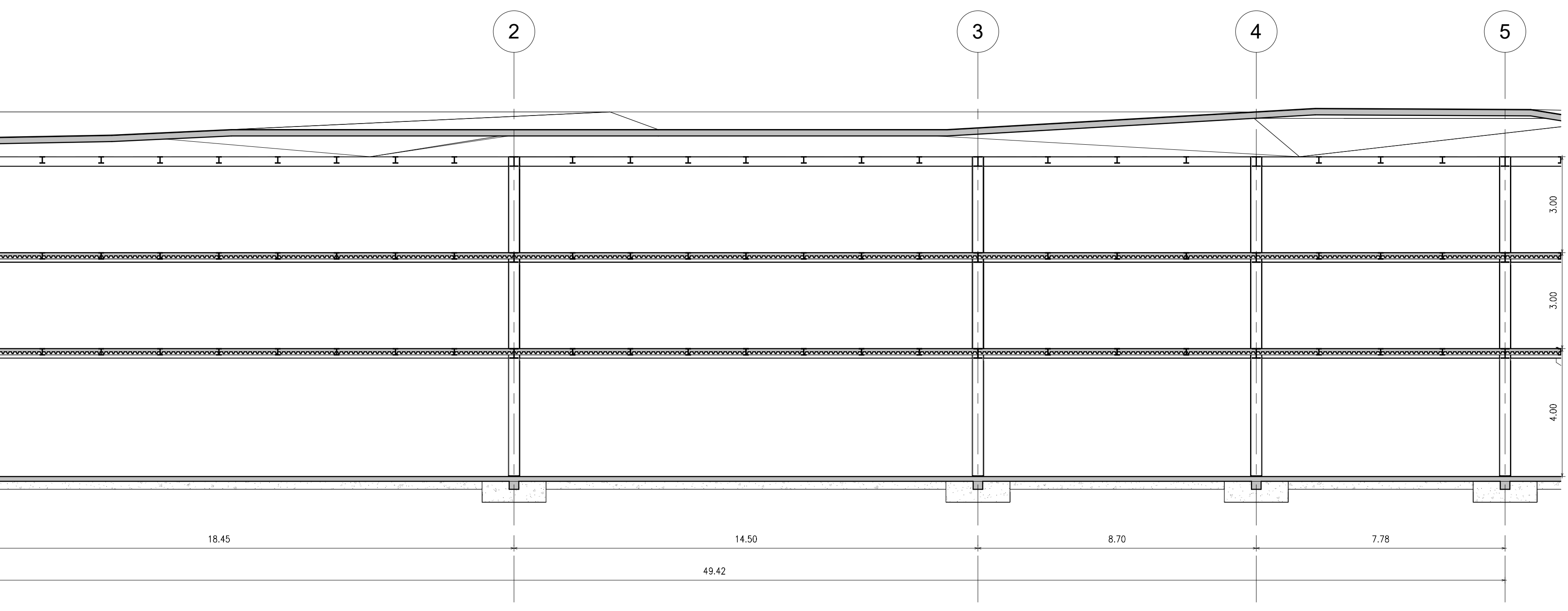

CORTE C-C

1:100

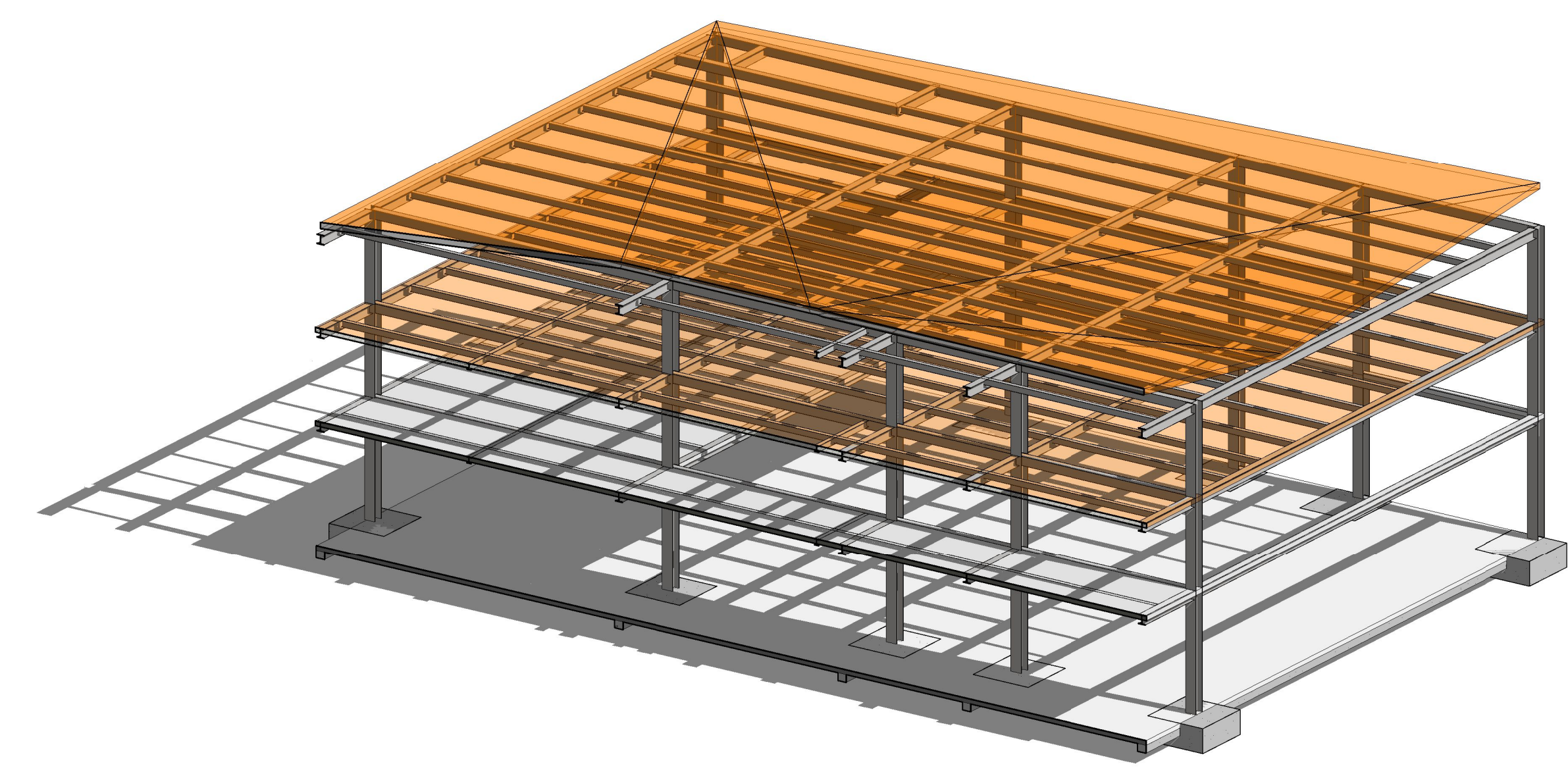

ISOMETRICO CORTE A-A

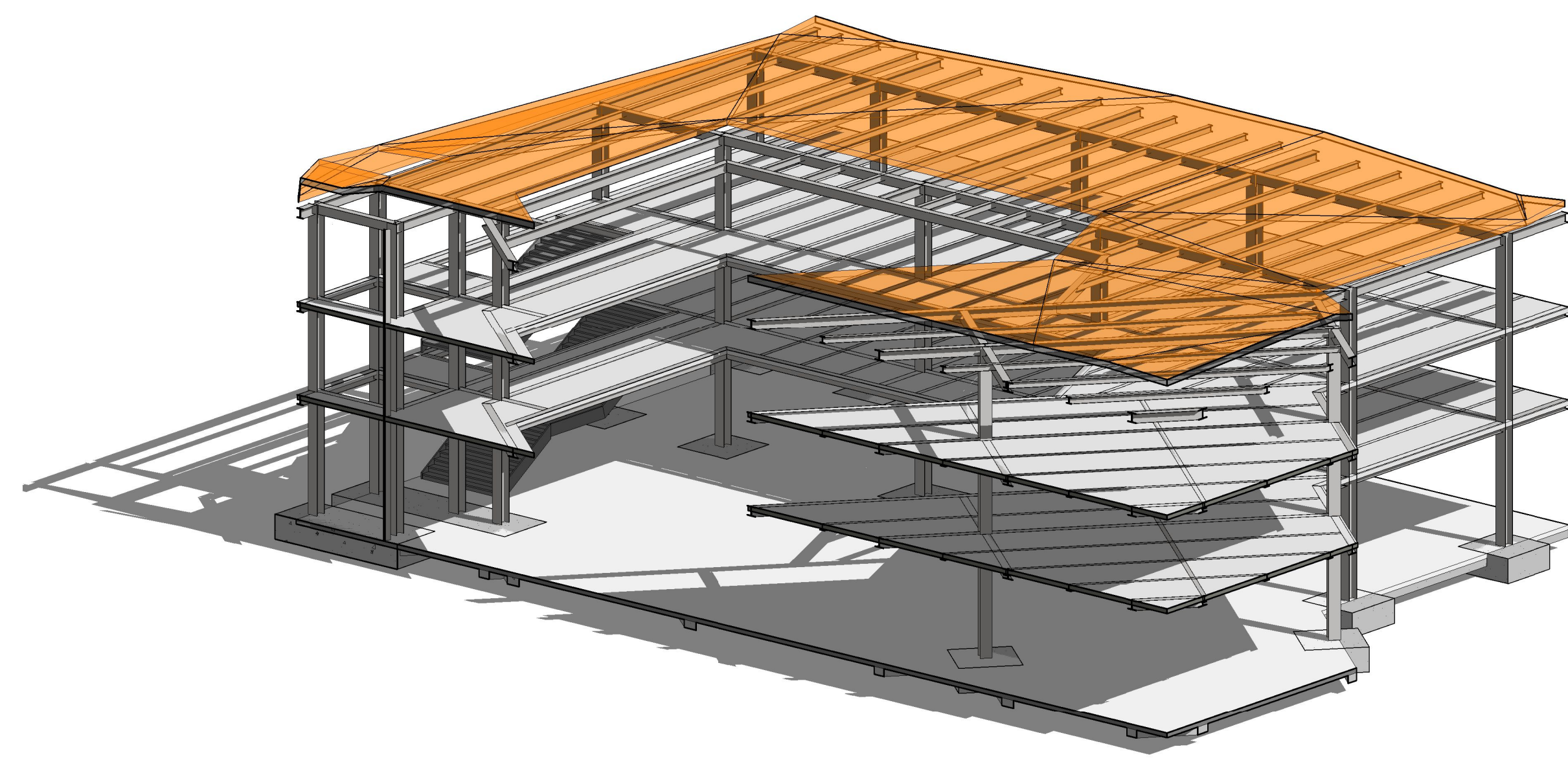

ISOMETRICO CORTE B-B

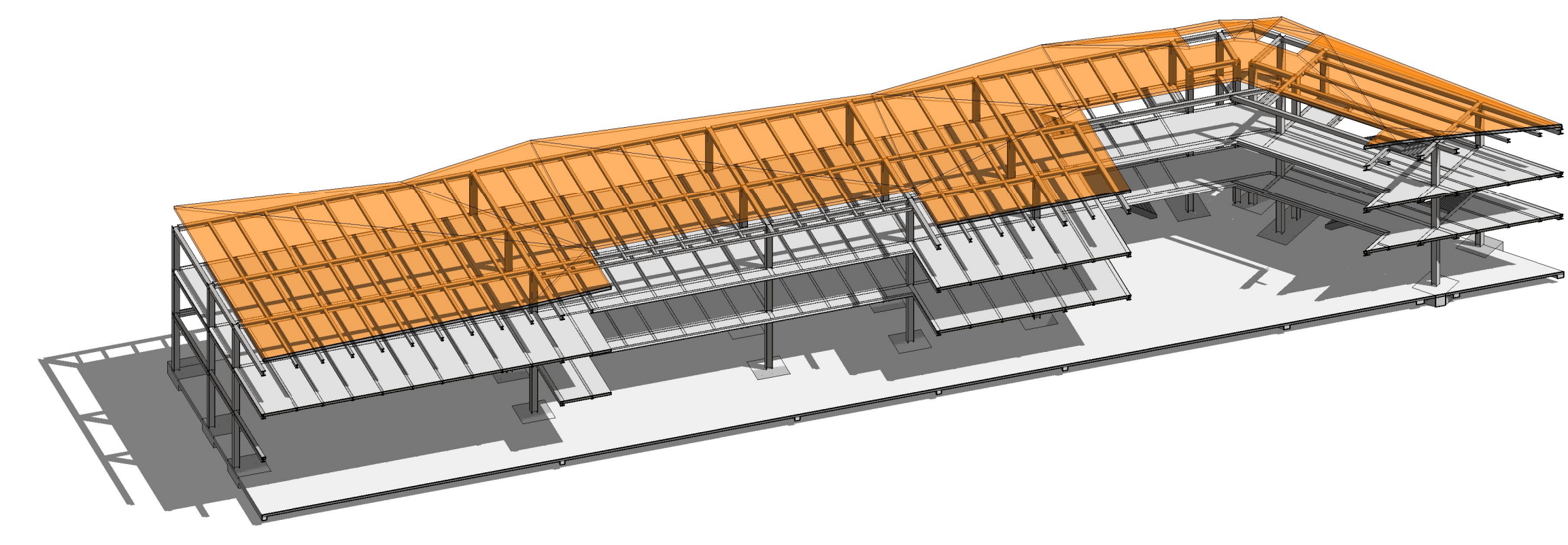

ISOMETRICO CORTE C-C

902V		NO. 001/20	
CONTIENE	SECCIONES	ESCALA INDICADA	FECHA 12/04/19
OBSERVACIONES:			
REVISION:			
OBSERVACIONES:			
PROFESOR:	ARQ. ALVARO JAVIER BOLAÑOS PALACIOS		
ESTUDIANTE:	NEVER FABIAN OVALLE PINEDA COD. 1.019.080.398	DIANA PAOLA PARCO MENDEZ COD. 1.019.080.398	
PROYECTO	CENTRO DE EDUCACIÓN TECNOLÓGICA MONGUI - BOYACA		
			
REVISION:	PLANCHAS:	PLANCHAS NO. DC	
A206			

1

2

3

4

5

6

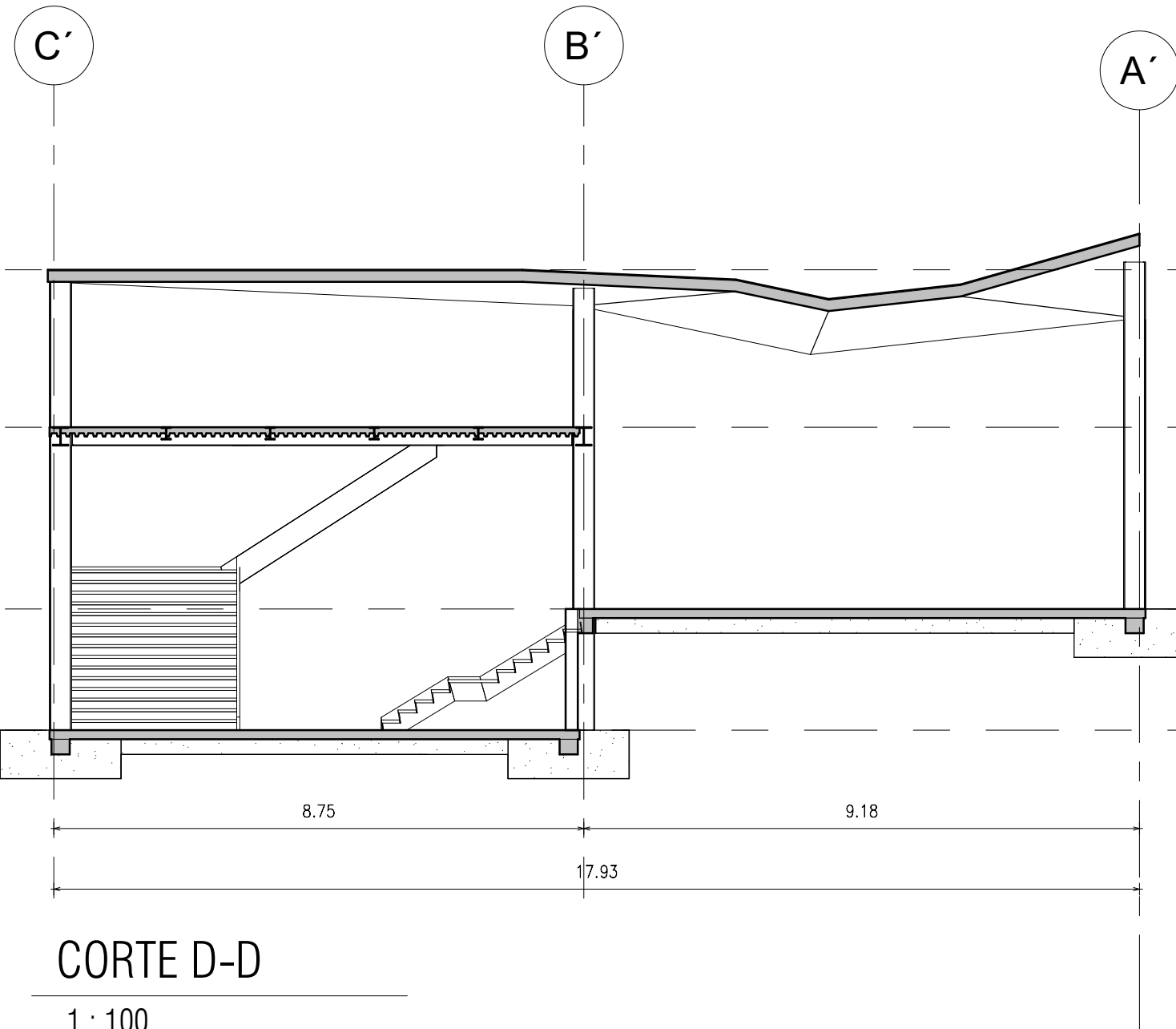

CORTE D-D
1 : 100

PLANTA CUBIERTA BIBLIOTECA
5.60

PLANTA PISO 2 BIBLIOTECA
3.00

PLANTA 1
0.00

PLANTA -1 BIBLIOTECA
-2.00

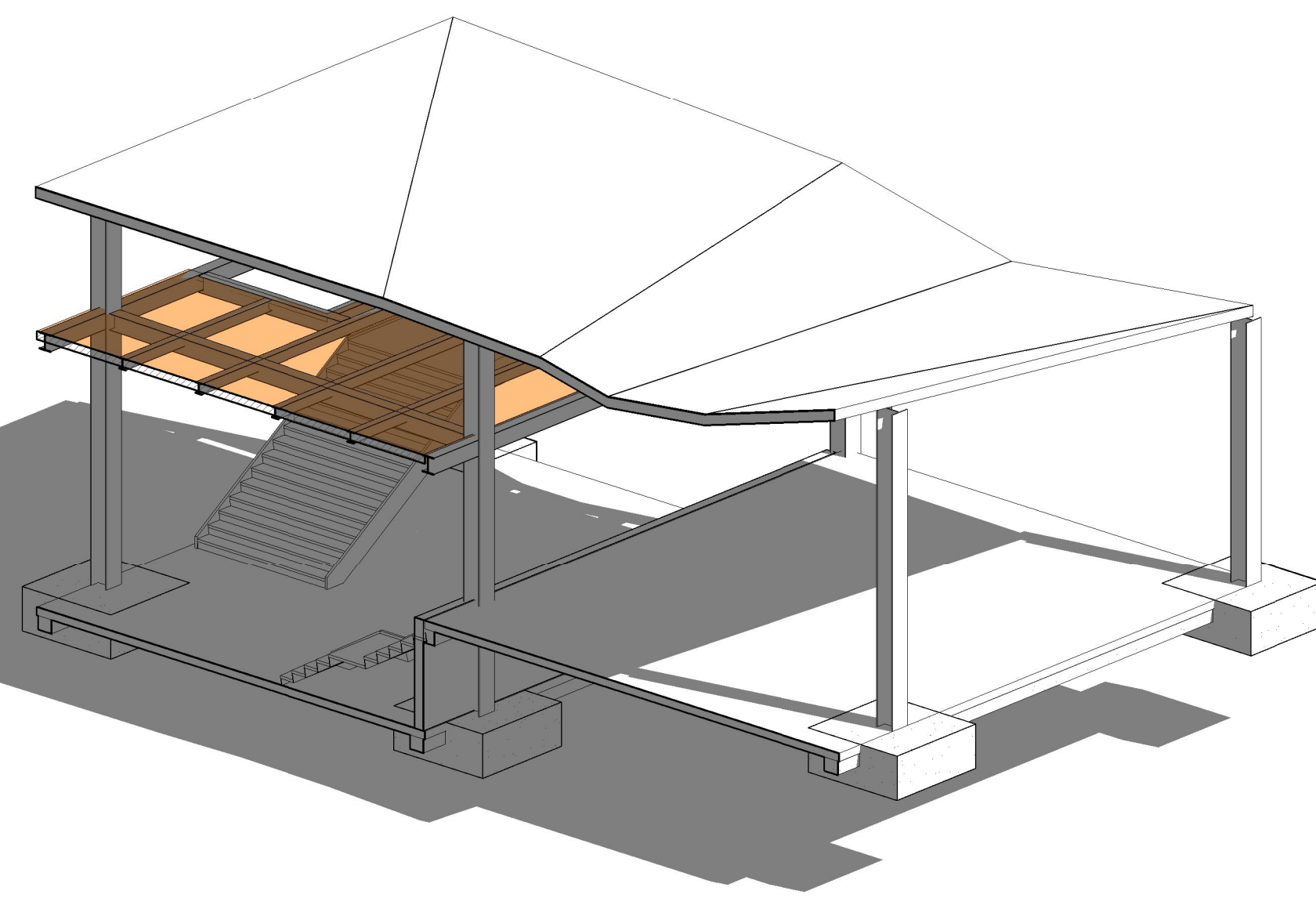

ISOMETRICO CORTE D-D

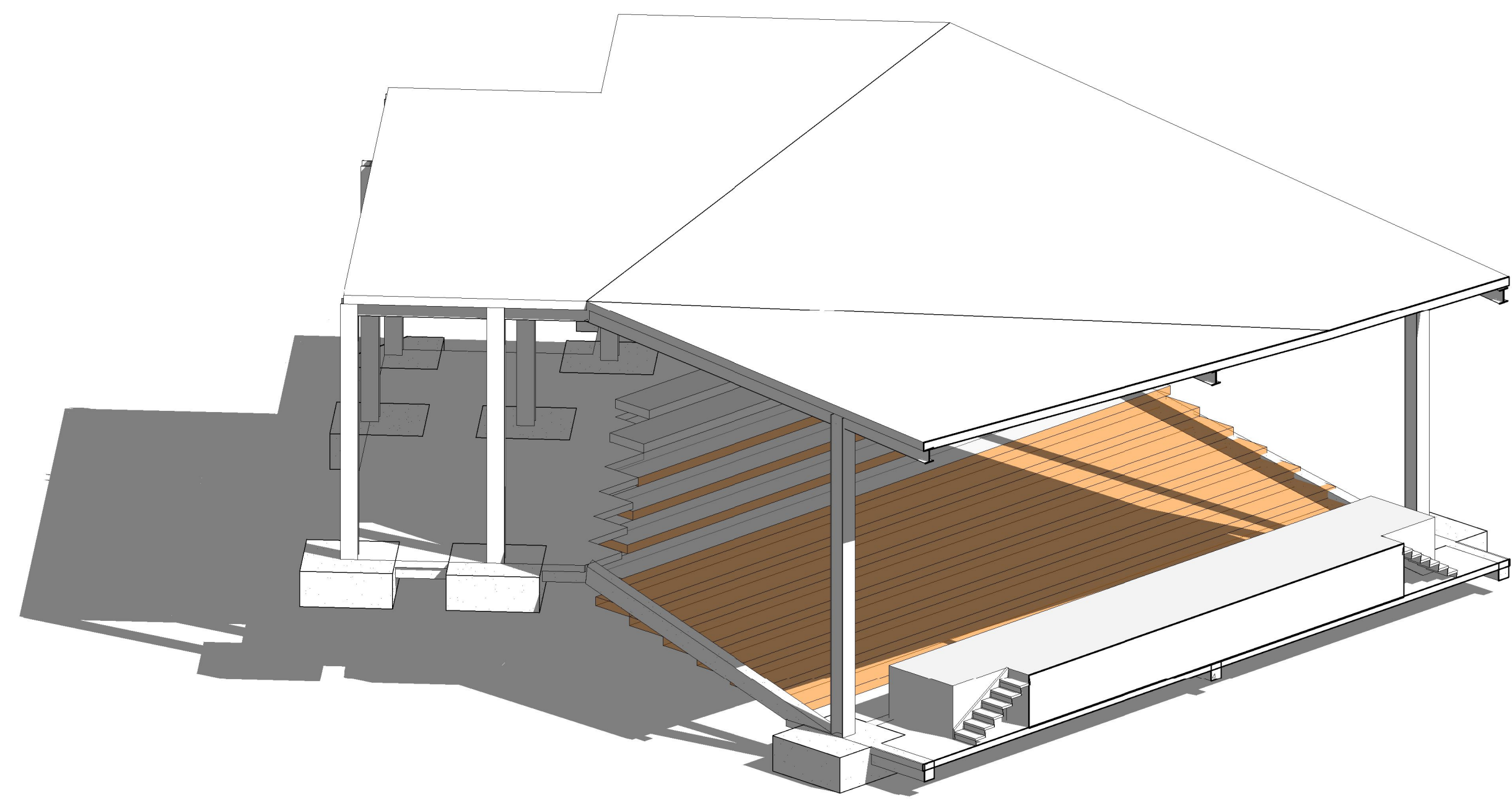

ISOMETRICO CORTE E-E

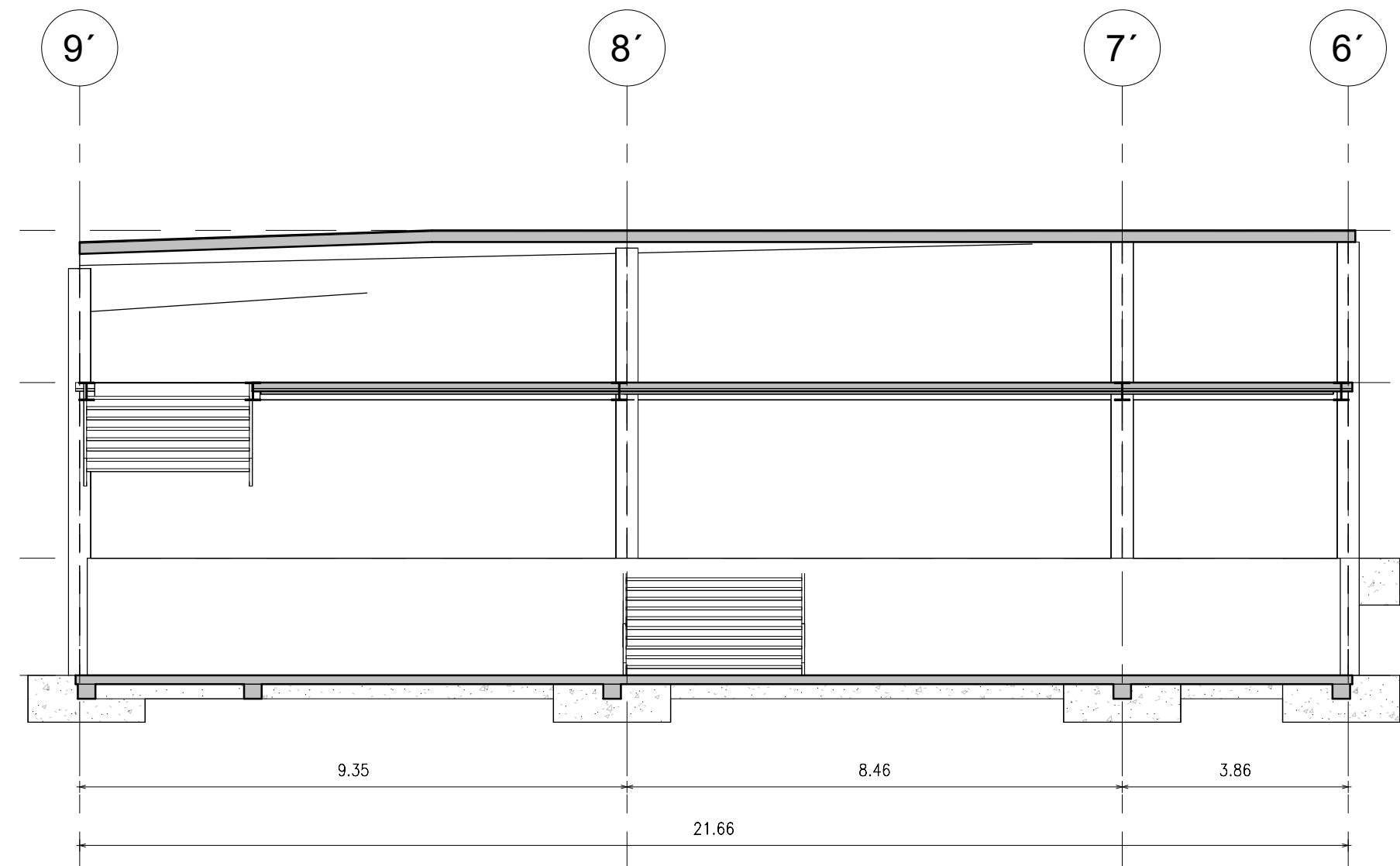

CORTE G-G
1 : 100

PLANTA CUBIERTA BIBLIOTECA
5.60

PLANTA PISO 2 BIBLIOTECA
3.00

PLANTA 1
0.00

PLANTA -1 BIBLIOTECA
-2.00

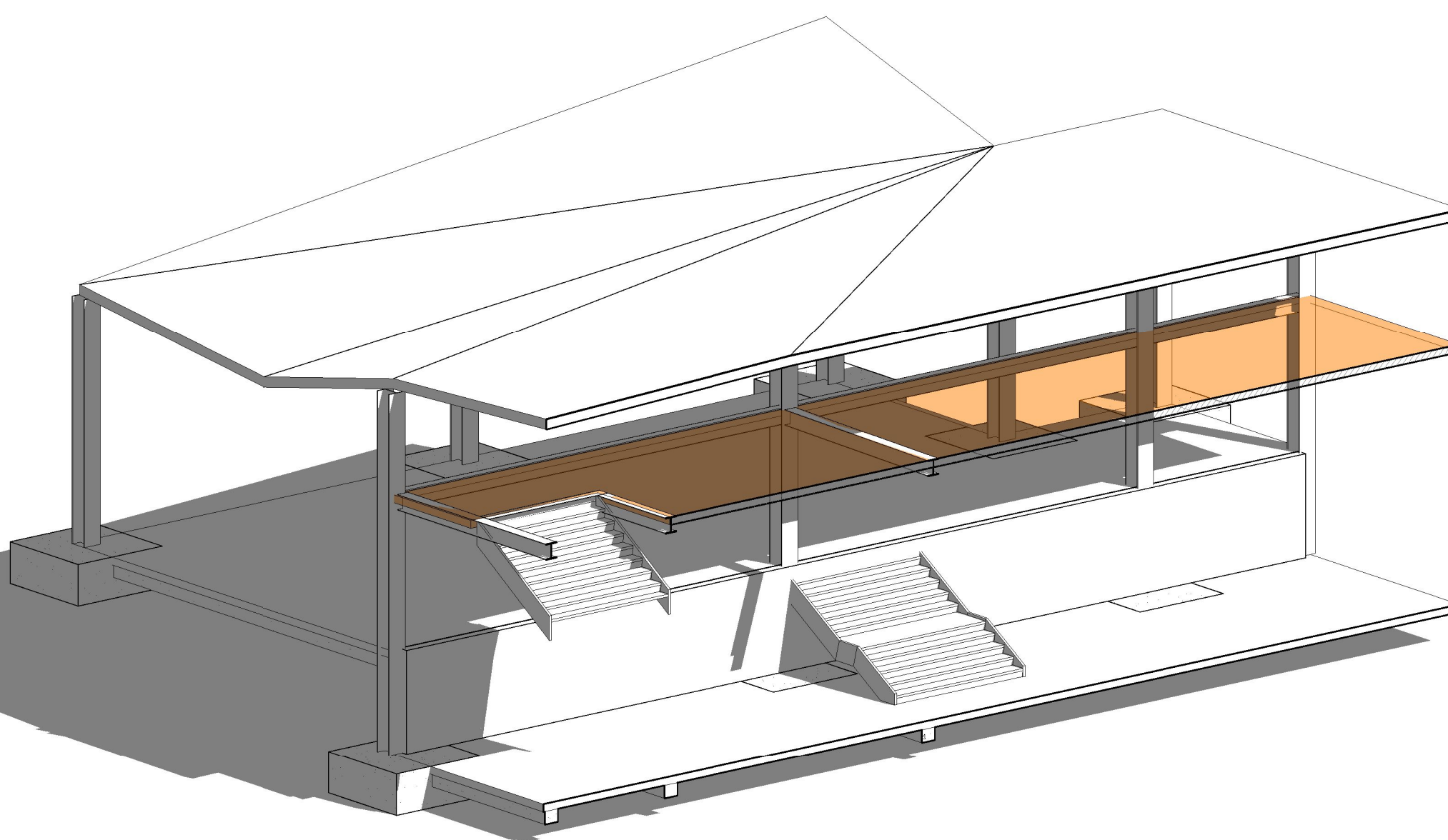

ISOMETRICO CORTE G-G

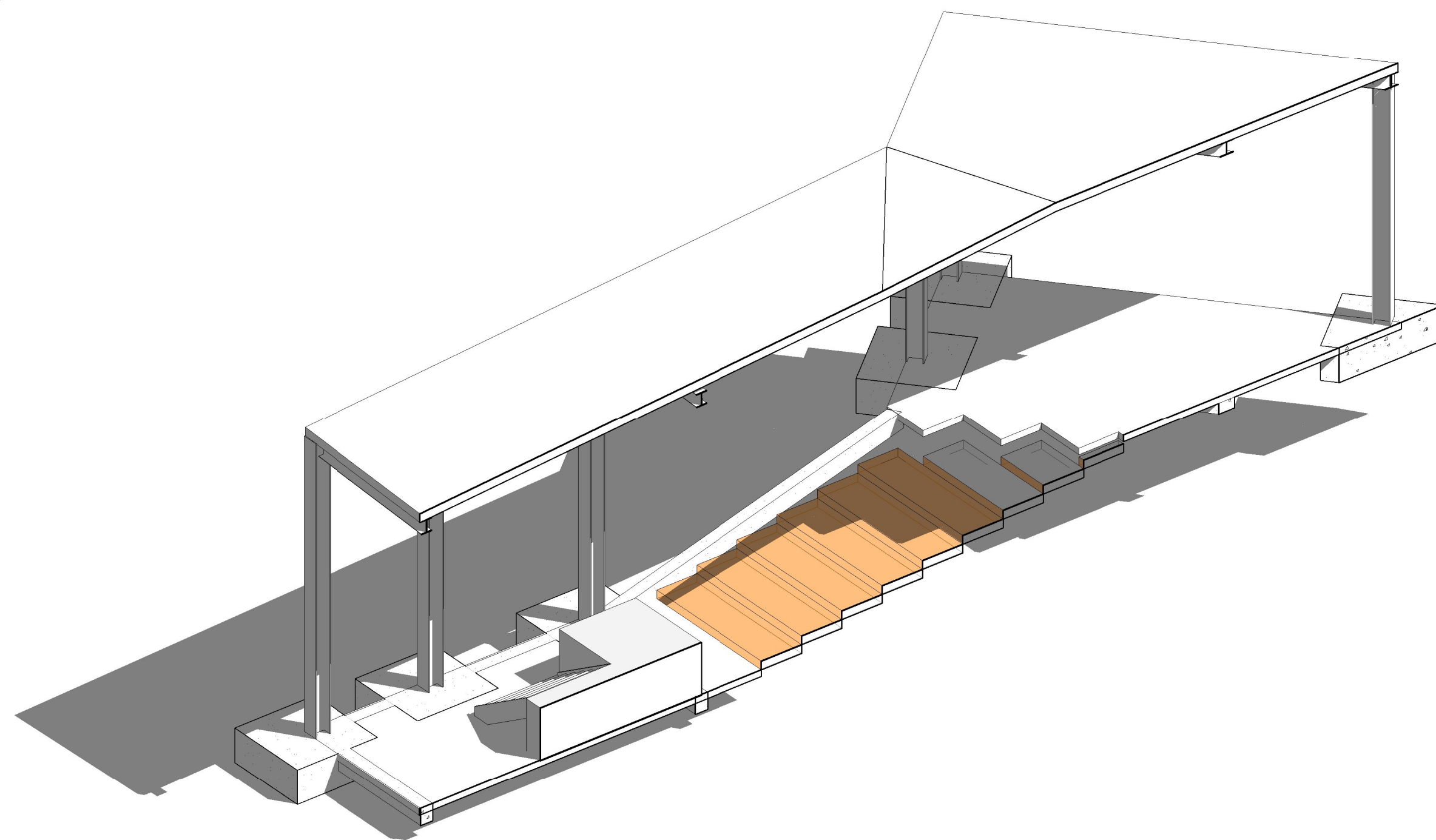

ISOMETRICO CORTE F-F

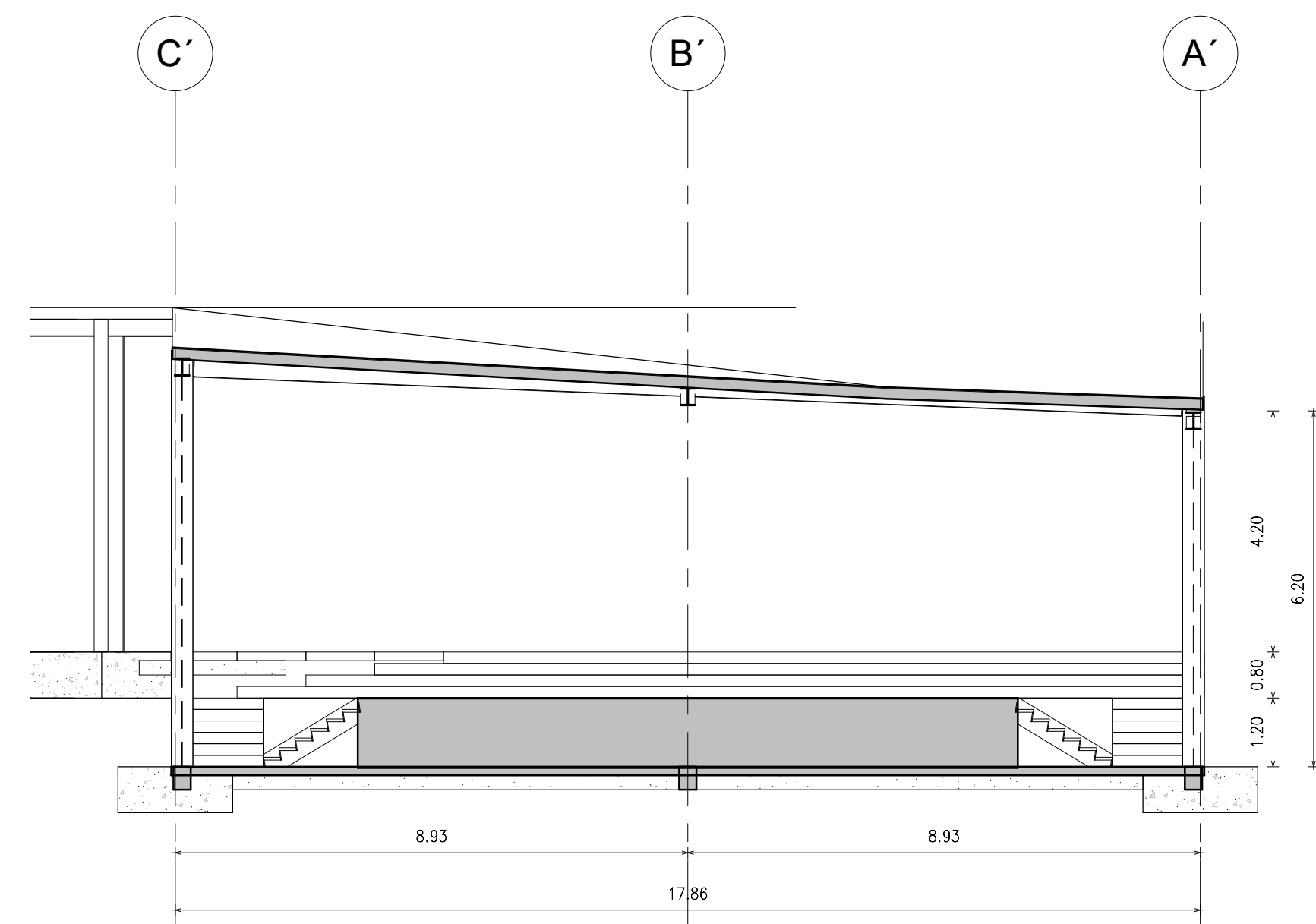

CORTE E-E
1 : 100

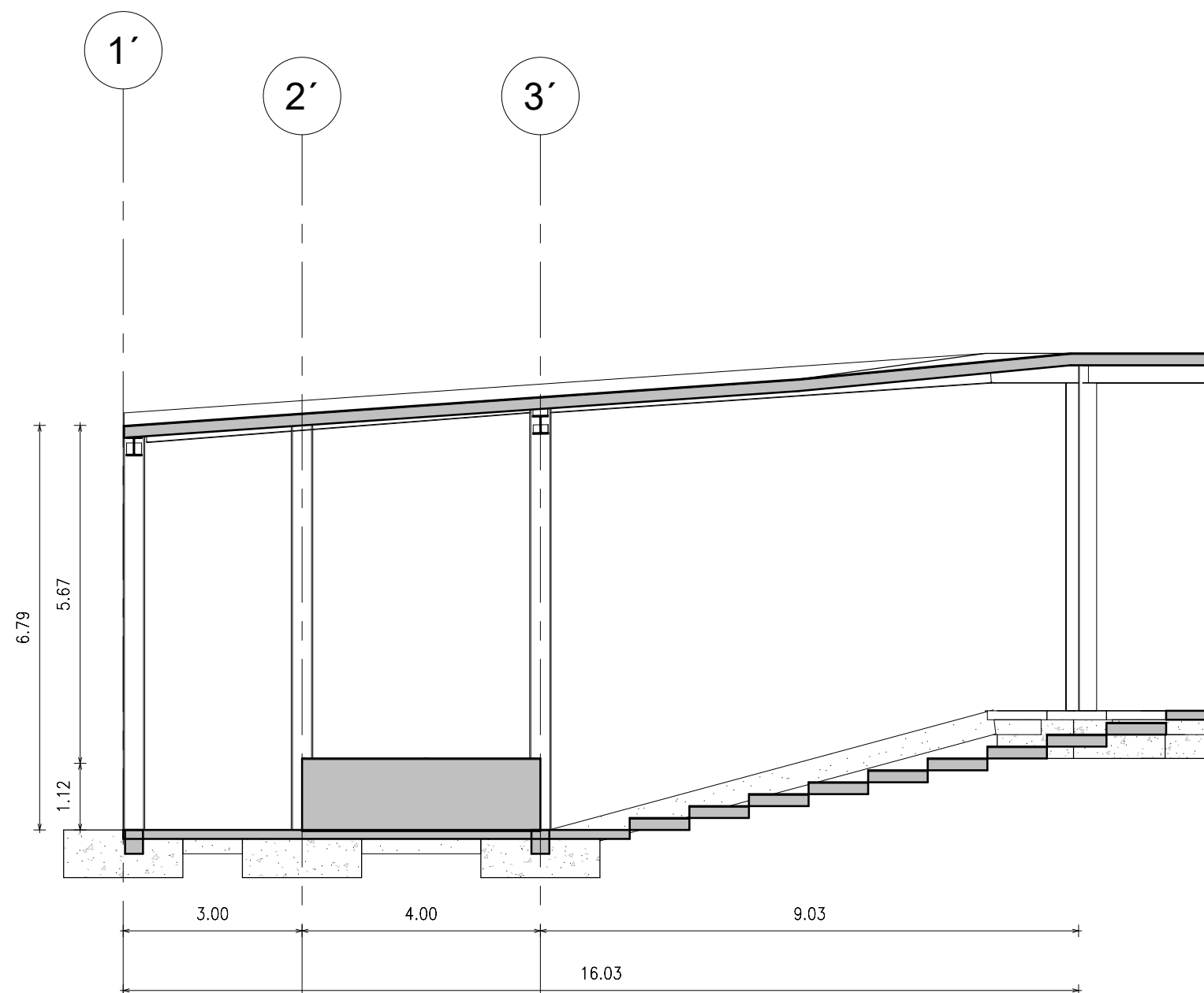

CORTE F-F
1 : 100

PLANCHILLA NO. A207	
CONTIENE	SECCIONES BIBLIOTECA Y AUDITORIO
FECHA INDICADA	12/08/19
OBSERVACIONES:	
REVISION:	
OBSERVACIONES:	
PROFESOR:	ARQ. ALVARO JAVIER BOLAÑOS PALACIOS
ESTUDIANTES:	NETER FABIAN OVALLE PINEDA COD. 1.019.080.398 DIANA PAOLA PARCO MENDEZ COD. 1.019.080.398
PROYECTO	CENTRO DE EDUCACIÓN TECNOLÓGICA MONGUI - BOYACA
	
REVISION:	PLANCHILLA NO. A207